



2015-2016



PEÇAS DE RESPOSIÇÃO PARA MÁQUINAS DE COSTURA INDUSTRIAIS

STRONG H

目录 INDEX

工业缝纫机刀类

KNIVES FOR INDUSTRIAL SEWING MACHINES



兄弟	BROTHER.....	2-6
杜克普	DURKOPP.....	7-8
龙帝	DINO.....	8
重机	JUKI.....	8-15
象王/杰克	JUMBOKING/JACK.....	15
关西	KANSAI SPECIAL.....	16-17
宝狮	KINGTEX.....	17-18
三菱	MITSUBISHI.....	18
梅罗/毛瑟/百福	MERROW/MAUSER/PFAFF.....	19
飞马	PEGASUS.....	20-22
利满地	RIMOLDI.....	22-24
银箭	SIRUBA.....	24-26
日星	SUN STAR.....	27
胜家	SINGER.....	27-28
利星/星菱	REECE/SHING LING.....	28
星锐/丰田	SHING RAY/TOYOTA.....	28
友联/威比玛	UNION SPECIAL/VIBEMAC.....	29
大和	YAMATO.....	30-32
纽朗/椰哈	NEWLONG/YAO HAN.....	32
其他	OTHERS.....	33-36
兄弟/重机	BROTHER/JUKI.....	37
杜克普	DURKOPP.....	38
利华/利星	LSM/REECE.....	39
胜家/杰克	SINGER/JACK.....	40
吊牌切打刀	SEWING TAG MACHINE CUTTER.....	32
剥皮刀	CUTTING LEATHER KNIFE.....	32-33

裁剪机系列刀类

KNIVES FOR CUTTING MACHINES



截断机圆刀	ROUND KNIVES FOR END CUTTER MACHINES.....	42-49
砥刀	LOWER KNIVES FOR ROUND KNIFE.....	48
分条机刀	CLOTH SLITTING KNIVES.....	50
CAD裁刀	CAD CUTTING KNIVES.....	51-56
钮门刀	BUTTON HOLE KNIVES.....	57
裁剪机刀箱	KNIFE SLIDE FOR CUTTING MACHINES.....	58
裁剪机直刀	STRAIGHT KNIVES FOR CUTTING MACHINES.....	59
裁剪机波刀	WAVE KNIVES FOR CUTTING MACHINES.....	60
裁剪机零部件	SPARE PARTS FOR CUTTING MACHINES.....	61-62
钢带刀	BAND KNIVES.....	63
片皮机刀	SKIVING BAND KNIVES.....	64

电脑绣花机刀类

KNIVES FOR COMPUTERIZED EMBROIDERY MACHINES



田岛	TAJIMA.....	66/67/68
百福	PFAFF.....	66
伸势达	SWF.....	66/67
HAPPY	HAPPY.....	66
ZSK/百灵达	ZSK/BARUDAN.....	67
其他	OTHERS.....	67
电脑绣花机附壳片壳刀类	KNIVES FOR COMPUTERIZED SEQUIN EMBROIDERY MACHINES.....	69-93

工业缝纫机针板剪线组件及梭床组

NEEDLE PLATE ASSEMBLY & SHUTTLE RACE ASSEMBLY FOR COMPUTERIZED EMBROIDERY MACHINES



兄弟	BROTHER.....	96-101
重机	JUKI.....	101-108
三菱/日星	MITSUBISI/SUN STAR.....	109
大和	YAMATO.....	110

工业缝纫机针位组

GAUGE SET FOR INDUSTRIAL SEWING MACHINES



兄弟	BROTHER.....	P114-P125
重机	JUKI.....	P126-136
关西	KANSAI SPECIAL.....	P137-P154
宝狮	KINGTEX.....	P155-P156
飞马	PEGASUS.....	P156-P170
银箭	SIRUBA.....	P170-P180
日星	SUN STAR.....	P181
大和	YAMATO.....	P181-P186

工业缝纫机针板

NEEDLE PLATE FOR INDUSTRIAL SEWING MACHINES



兄弟	BROTHER.....	P188-P190
重机	JUKI.....	P191-P195
关西	KANSAI SPECIAL.....	P195-P198
宝狮	KINGTEX.....	P199-P201
飞马	PEGASUS.....	P201-P204
银箭	SIRUBA.....	P204-P207
大和	YAMATO.....	P207-P210
三菱/星菱/星锐/胜家	MITSUBISI/SHING LING/SHING RAY/SINGER.....	P211
日星	SUN STAR.....	P211-P212
友联/百福/海菱	UNION SPECIAL/PFAFF/HIGHLEAD.....	P212
其他	OTHERS.....	P212

工业缝纫机牙齿

FEED DOG FOR INDUSTRIAL SEWING MACHINES



兄弟/重机	BROTHER/JUKI.....	P213
关西	KANSAI SPECIAL.....	P213-P214
星锐/飞马	SHING RAY/PEGASUS.....	P214
银箭/日星	SIRUBA/SUN STAR.....	P214
大和	YAMATO.....	P214-P215

工业缝纫机压脚

PRESSER FOOT FOR INDUSTRIAL SEWING MACHINES



兄弟	BROTHER.....	P216
关西	KANSAI SPECIAL.....	P216
重机	JUKI.....	P217-P218
飞马	PEGASUS.....	P219
银箭	SIRUBA.....	P219-P220
大和	YAMATO.....	P220

工业缝纫机针钳

NEEDLE CLAMP FOR INDUSTRIAL SEWING MACHINES



兄弟/重机/宝狮	BROTHER/JUKI/KINGTEX.....	P221
星菱/星锐/关西	SHING LING/SHING RAY/KANSAI SPECIAL.....	P221
飞马/百福/银箭	PEGASUS/PFAFF/SIRUBA.....	P222
日星/大和	SUN STAR/YAMATO.....	P223

索引

PARTS LIST

224-247

蓝色文字为产品品号 Item In Blue Is Part No.

黑色文字为产品机型 Item In Black Is Model



KNIVES

for industrial sewing machines
工业缝纫机刀类



2015-2016 Catalogue

工业缝纫机刀类 KNIVES FOR INDUSTRIAL SEWING MACHINES INDUSTRIAL SEWING MACHINE SPARE PARTS



FOR BROTHER/兄弟

1-1	1-2	1-3	1-4	1-5	1-6	1-7
112436-001 B531	S28352-001 B272	S20582-001 N11	S20583-001 N11	S20899-001 N11	S09101-001 B271	144074-001 B531
2-1	2-2	2-3	2-4	2-5	2-6	2-7
144074-300 B531	148342-001 B511	148815-001 B531	S20579-101 N11	S20896-101 N11	S20897-101 N11	S20898-101 N11
3-1	3-2	3-3	3-4	3-5	3-6	3-7
140242-001 B500/B600	S09093-001 B271	S09094-001 B271	S28348-001	140888-001 EF2-B531	S28850-201	S28854-001
4-1	4-2	4-3	4-4	4-5	4-6	4-7
S16413-001 B787-4	S10605-001 SL-777B	S16248-001 S16248-001.SH BAS-610	S07525-000 T8452/T8752	S07527-001 T8452/T8752	S07526-001 T-842/T-845 /T-875	S07526-201 T8452/T8752



工业缝纫机刀类
KNIVES FOR INDUSTRIAL SEWING MACHINES
INDUSTRIAL SEWING MACHINE SPARE PARTS

FOR BROTHER/兄弟

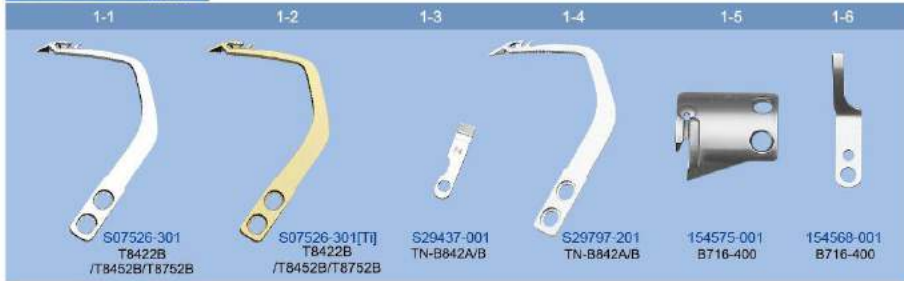

工业缝纫机刀类
KNIVES FOR INDUSTRIAL SEWING MACHINES
INDUSTRIAL SEWING MACHINE SPARE PARTS

FOR BROTHER/兄弟

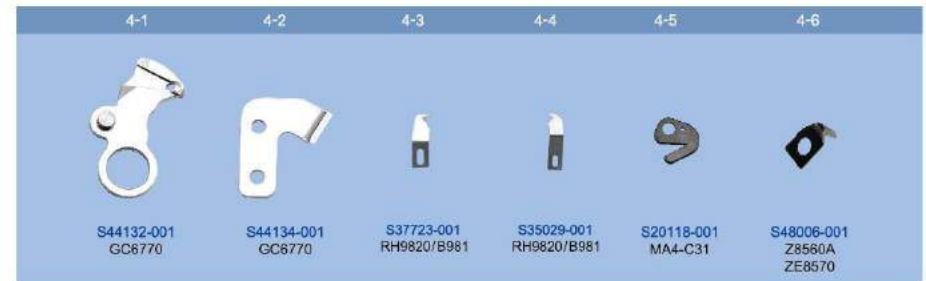



工业缝纫机刀类

KNIVES FOR INDUSTRIAL SEWING MACHINES

INDUSTRIAL SEWING MACHINE SPARE PARTS

FOR BROTHER/兄弟



工业缝纫机刀类

KNIVES FOR INDUSTRIAL SEWING MACHINES

INDUSTRIAL SEWING MACHINE SPARE PARTS

FOR BROTHER/兄弟



FOR DURKOPP/杜克普





工业缝纫机刀类

KNIVES FOR INDUSTRIAL SEWING MACHINES

INDUSTRIAL SEWING MACHINE SPARE PARTS

FOR DURKOPP/杜克普



工业缝纫机刀类

KNIVES FOR INDUSTRIAL SEWING MACHINES

INDUSTRIAL SEWING MACHINE SPARE PARTS



FOR DURKOPP/杜克普



FOR DINO/龙帝



FOR JUKI/重机

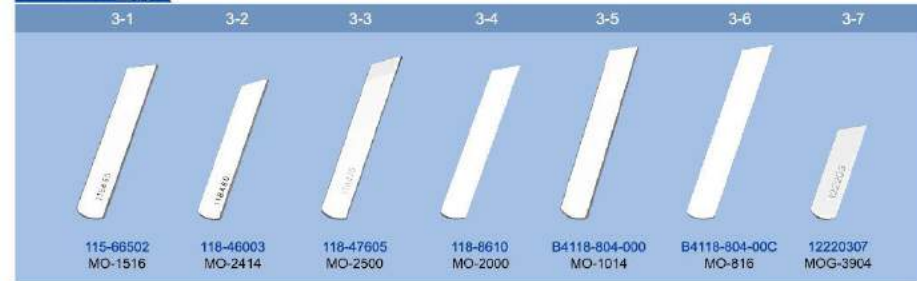



工业缝纫机刀类

KNIVES FOR INDUSTRIAL SEWING MACHINES

INDUSTRIAL SEWING MACHINE SPARE PARTS

FOR JUKI/重机



工业缝纫机刀类

KNIVES FOR INDUSTRIAL SEWING MACHINES

INDUSTRIAL SEWING MACHINE SPARE PARTS



FOR JUKI/重机

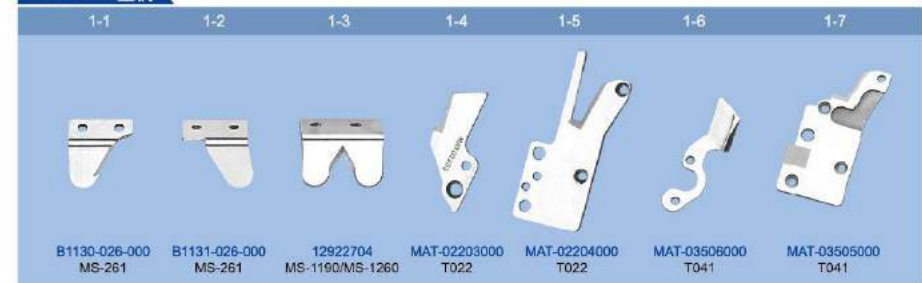



工业缝纫机刀类

KNIVES FOR INDUSTRIAL SEWING MACHINES

INDUSTRIAL SEWING MACHINE SPARE PARTS

FOR JUKI/重机

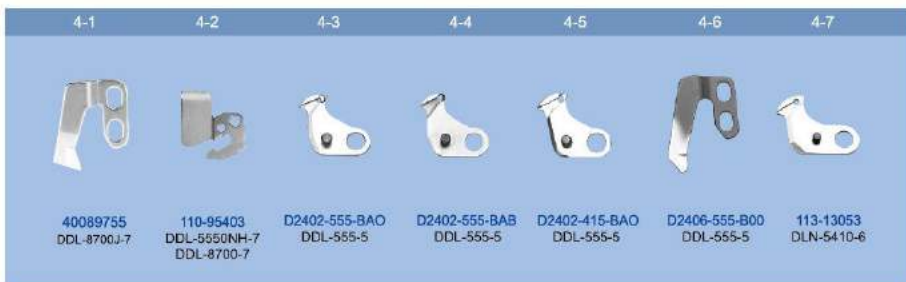

工业缝纫机刀类

KNIVES FOR INDUSTRIAL SEWING MACHINES

INDUSTRIAL SEWING MACHINE SPARE PARTS



FOR JUKI/重机





工业缝纫机刀类

KNIVES FOR INDUSTRIAL SEWING MACHINES

INDUSTRIAL SEWING MACHINE SPARE PARTS

FOR JUKI/重机

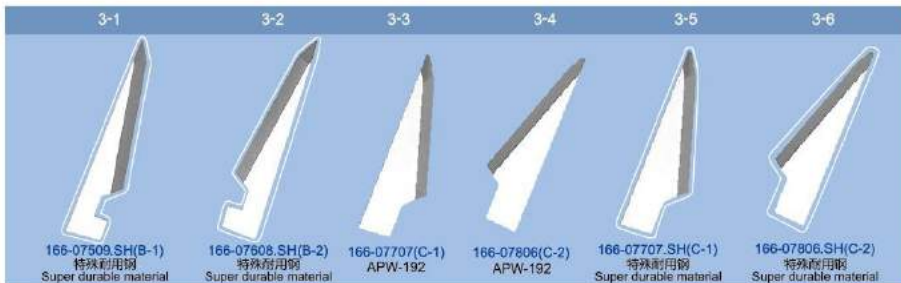
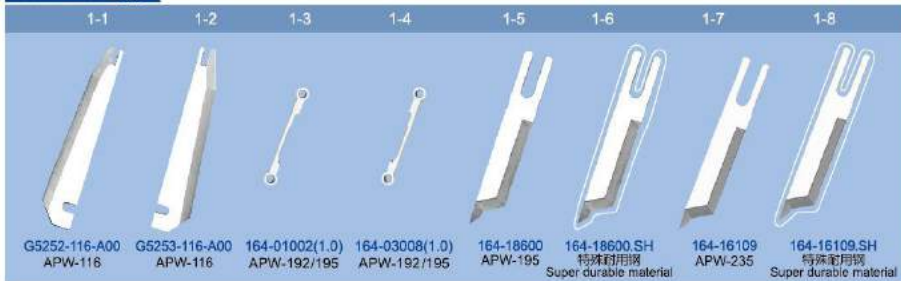

工业缝纫机刀类

KNIVES FOR INDUSTRIAL SEWING MACHINES

INDUSTRIAL SEWING MACHINE SPARE PARTS



FOR JUKI/重机

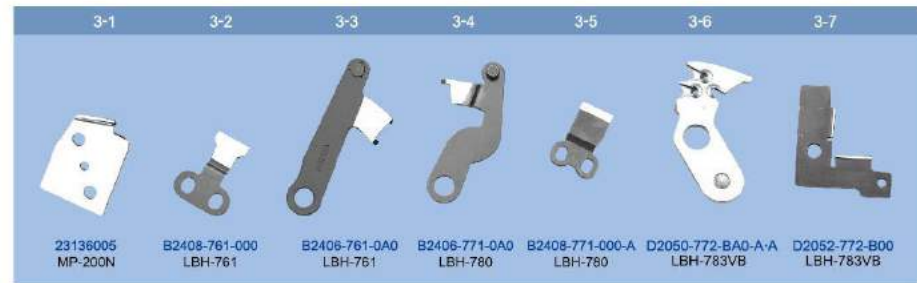
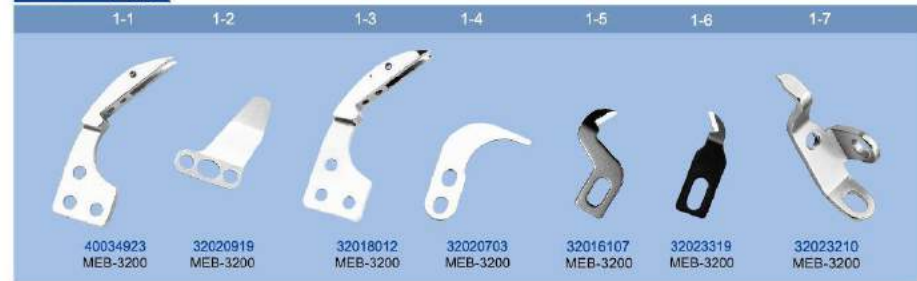



工业缝纫机刀类

KNIVES FOR INDUSTRIAL SEWING MACHINES

INDUSTRIAL SEWING MACHINE SPARE PARTS

FOR JUKI/重机



FOR JUMBOKING/象王



FOR JACK/杰克

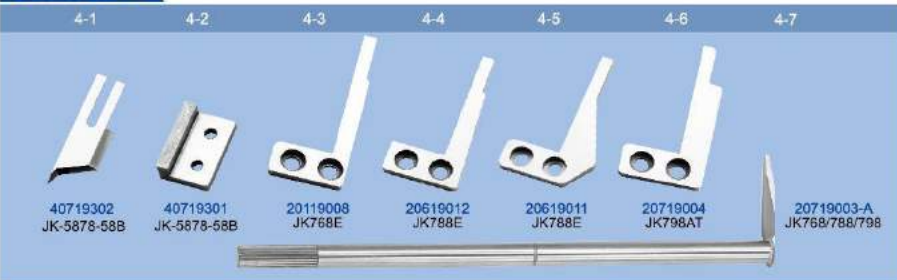

工业缝纫机刀类

KNIVES FOR INDUSTRIAL SEWING MACHINES

INDUSTRIAL SEWING MACHINE SPARE PARTS



FOR KANSAI SPECIAL/关西

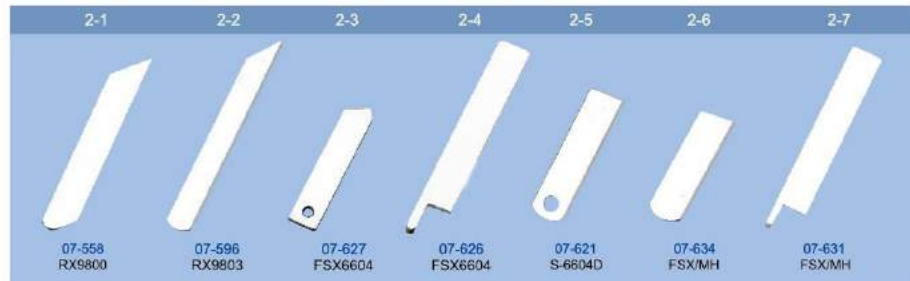



工业缝纫机刀类

KNIVES FOR INDUSTRIAL SEWING MACHINES

INDUSTRIAL SEWING MACHINE SPARE PARTS

FOR KANSAI SPECIAL/关西

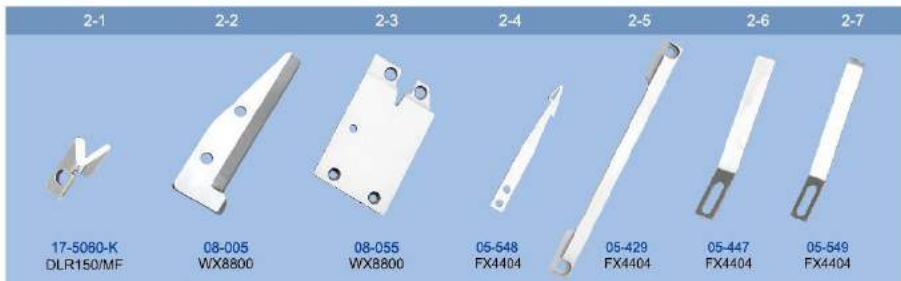
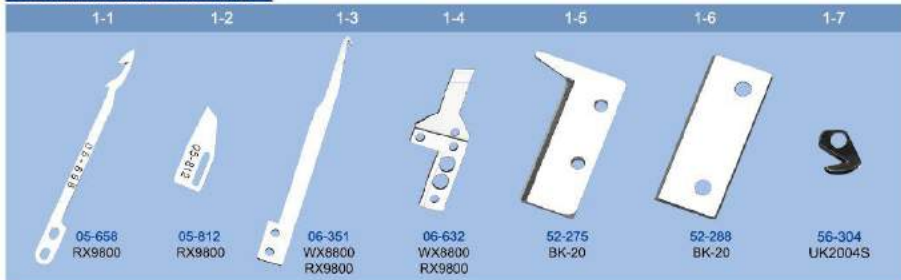

FOR KINGTEX/宝狮

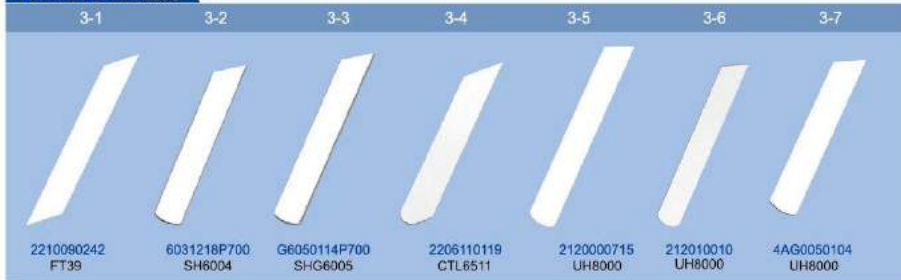

工业缝纫机刀类

KNIVES FOR INDUSTRIAL SEWING MACHINES

INDUSTRIAL SEWING MACHINE SPARE PARTS

FOR KINGTEX/宝狮



FOR MITSUBISHI/三菱





工业缝纫机刀类
KNIVES FOR INDUSTRIAL SEWING MACHINES
INDUSTRIAL SEWING MACHINE SPARE PARTS

FOR MERROW/梅罗

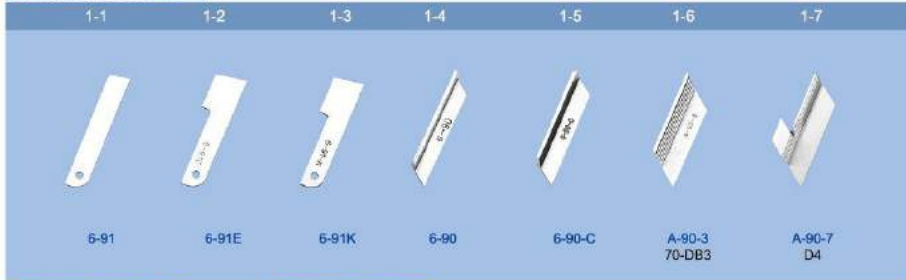

FOR MAUSER/毛瑟



FOR PFAFF/百福



工业缝纫机刀类
KNIVES FOR INDUSTRIAL SEWING MACHINES
INDUSTRIAL SEWING MACHINE SPARE PARTS



FOR PEGASUS/飞马

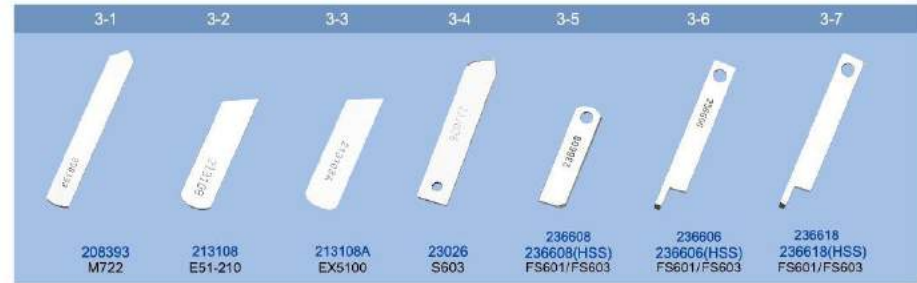
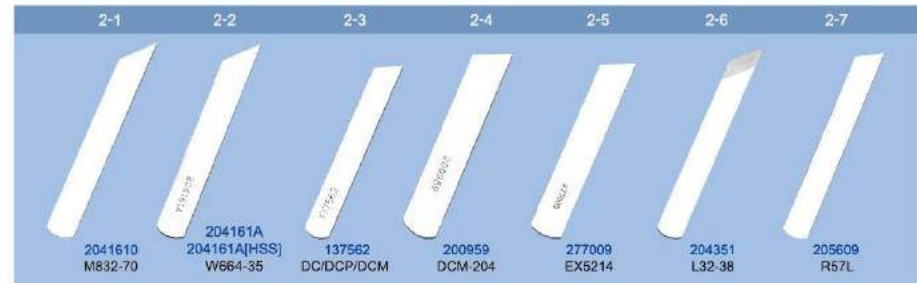
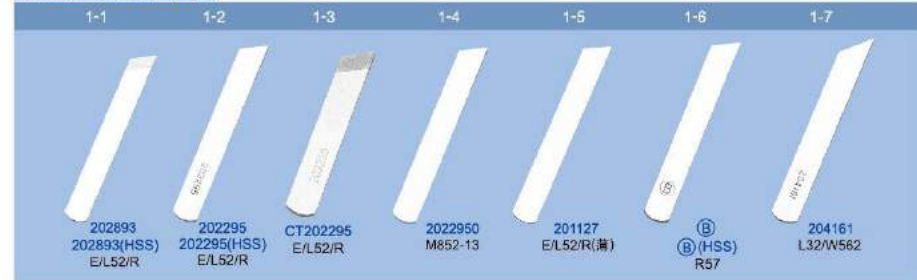



工业缝纫机刀类

KNIVES FOR INDUSTRIAL SEWING MACHINES

INDUSTRIAL SEWING MACHINE SPARE PARTS

FOR PEGASUS/飞马

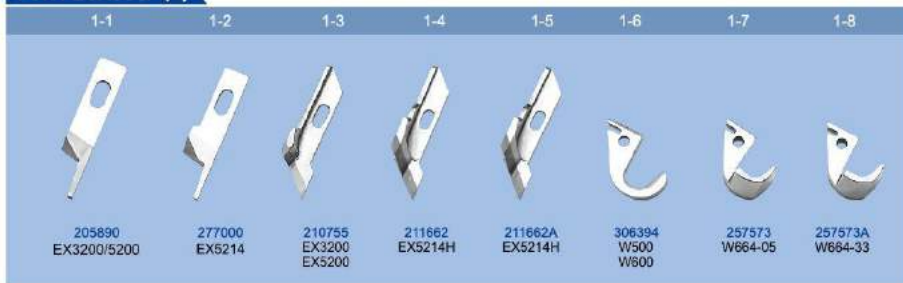

工业缝纫机刀类

KNIVES FOR INDUSTRIAL SEWING MACHINES

INDUSTRIAL SEWING MACHINE SPARE PARTS

FOR PEGASUS/飞马

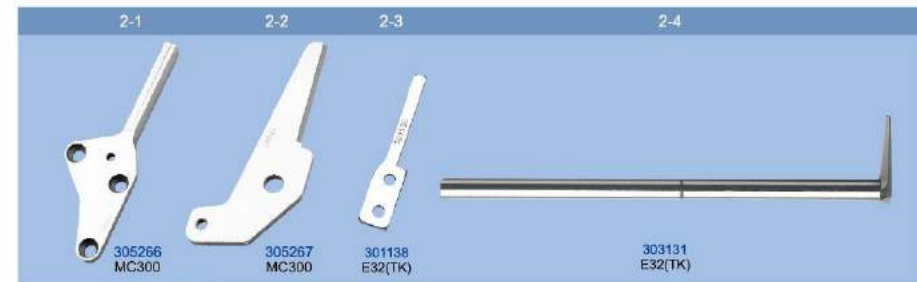
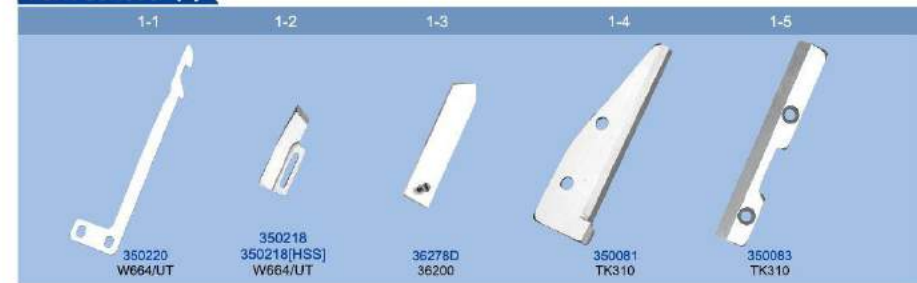

FOR RIMOLDI/利满地





工业缝纫机刀类

KNIVES FOR INDUSTRIAL SEWING MACHINES

INDUSTRIAL SEWING MACHINE SPARE PARTS

FOR RIMOLDI/利满地

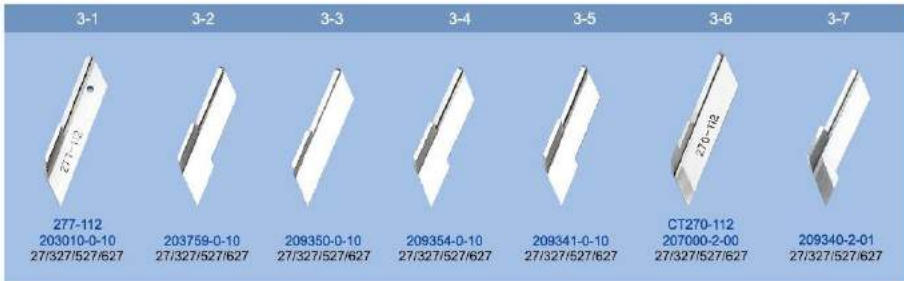
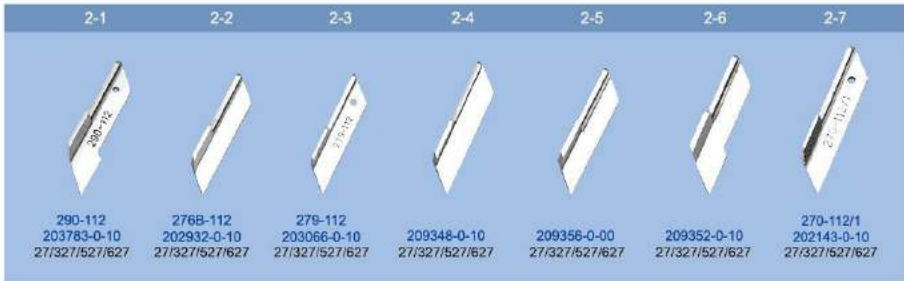

工业缝纫机刀类

KNIVES FOR INDUSTRIAL SEWING MACHINES

INDUSTRIAL SEWING MACHINE SPARE PARTS

FOR RIMOLDI/利满地

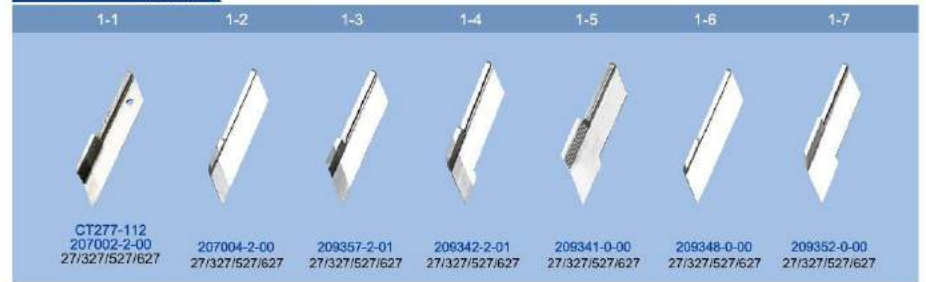

FOR SIRUBA/银箭

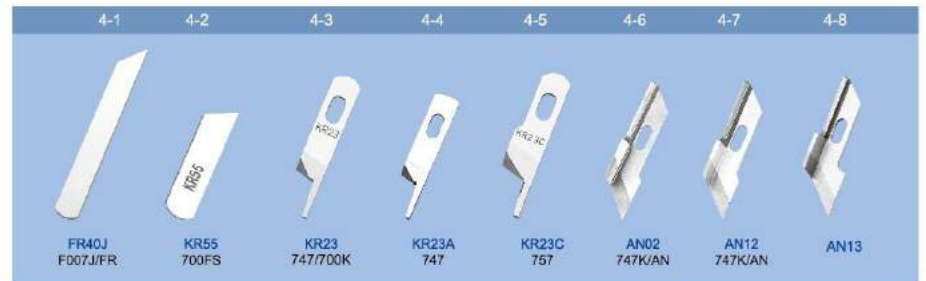
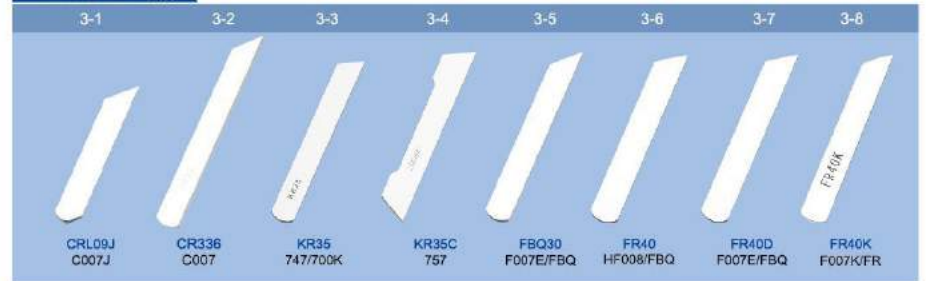



工业缝纫机刀类

KNIVES FOR INDUSTRIAL SEWING MACHINES

INDUSTRIAL SEWING MACHINE SPARE PARTS

FOR SIRUBA/银箭

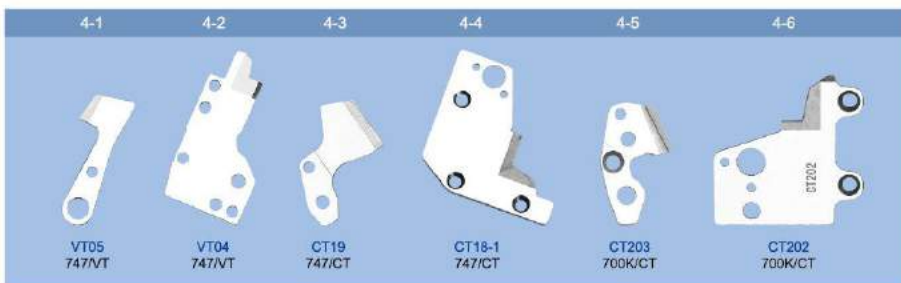
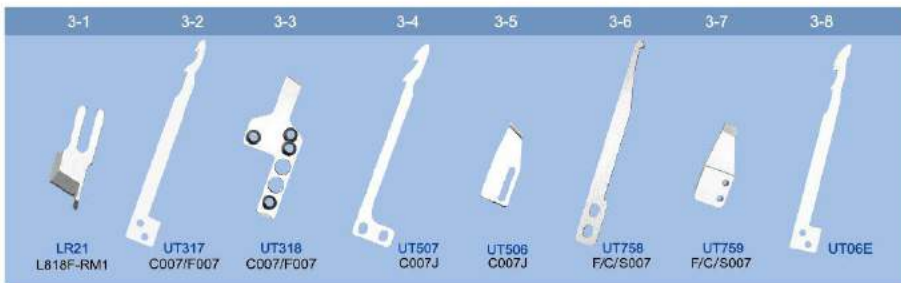

工业缝纫机刀类

KNIVES FOR INDUSTRIAL SEWING MACHINES

INDUSTRIAL SEWING MACHINE SPARE PARTS

FOR SIRUBA/银箭

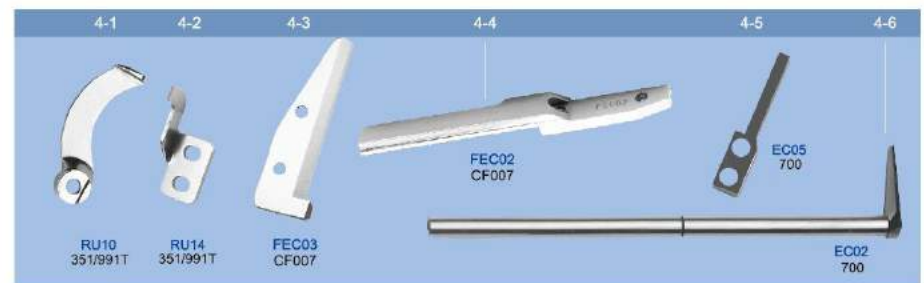
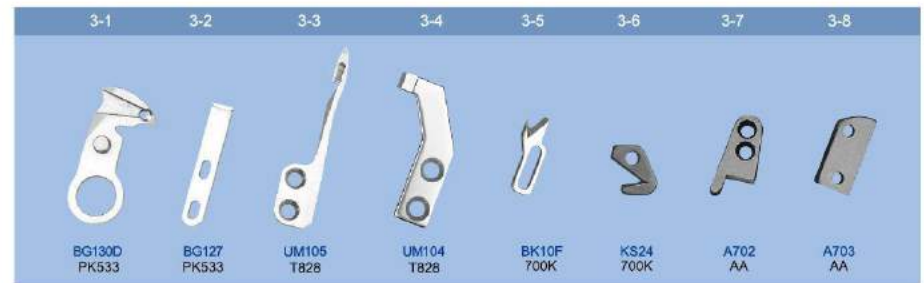
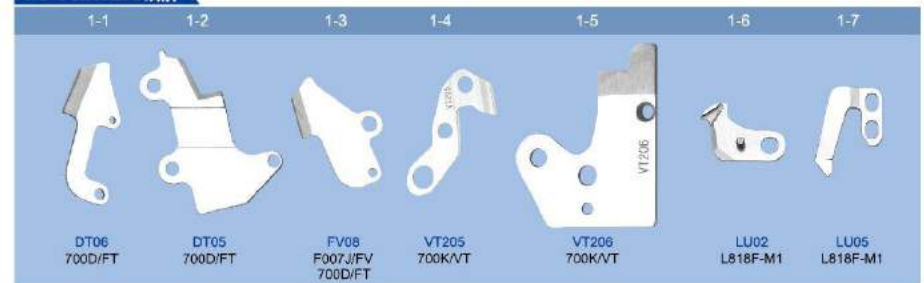



工业缝纫机刀类
KNIVES FOR INDUSTRIAL SEWING MACHINES
INDUSTRIAL SEWING MACHINE SPARE PARTS

FOR SUN STAR/日星



FOR SINGER/胜家

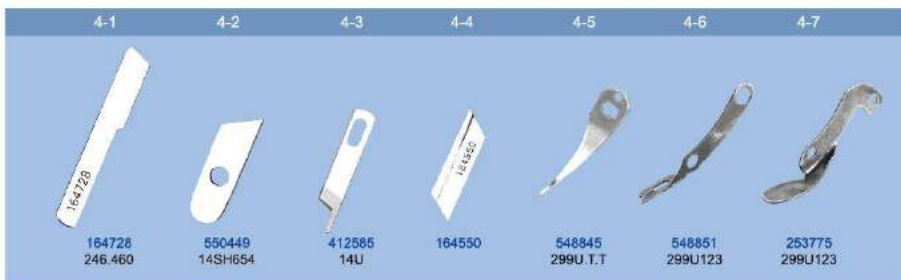

工业缝纫机刀类
KNIVES FOR INDUSTRIAL SEWING MACHINES
INDUSTRIAL SEWING MACHINE SPARE PARTS

FOR SINGER/胜家



FOR REECE/利是

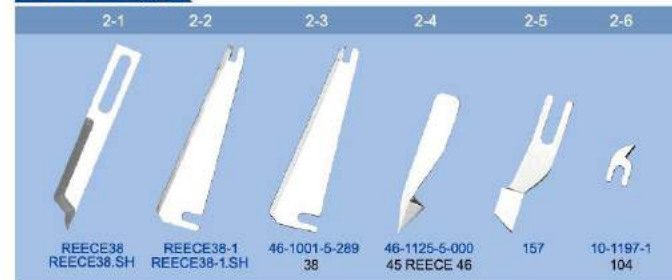

FOR SHING LING/星菱



FOR SHING RAY/星锐



FOR TOYOTA/丰田





工业缝纫机刀类

KNIVES FOR INDUSTRIAL SEWING MACHINES

INDUSTRIAL SEWING MACHINE SPARE PARTS

FOR UNION SPECIAL/友联

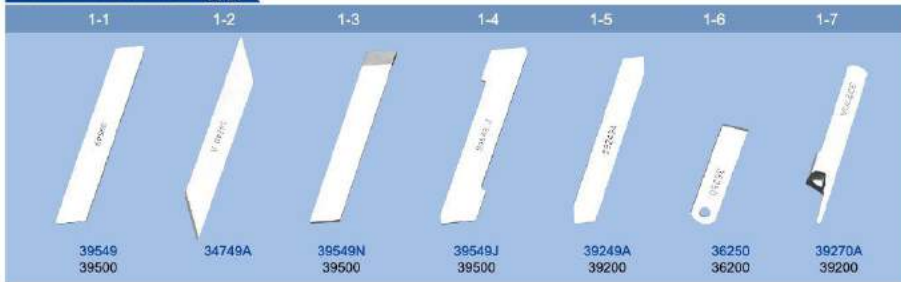

FOR VIBEMAC/威比玛

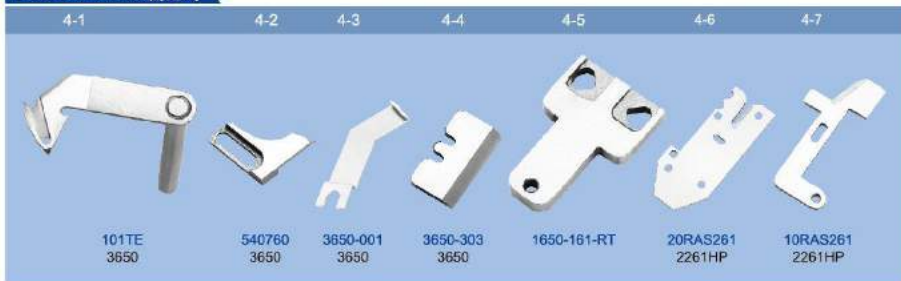

工业缝纫机刀类

KNIVES FOR INDUSTRIAL SEWING MACHINES

INDUSTRIAL SEWING MACHINE SPARE PARTS



FOR YAMATO/大和

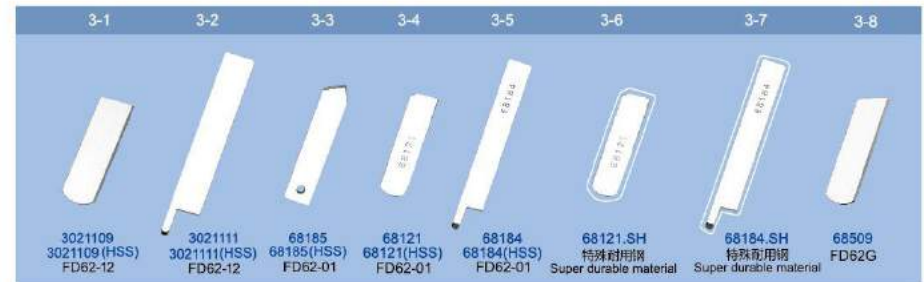
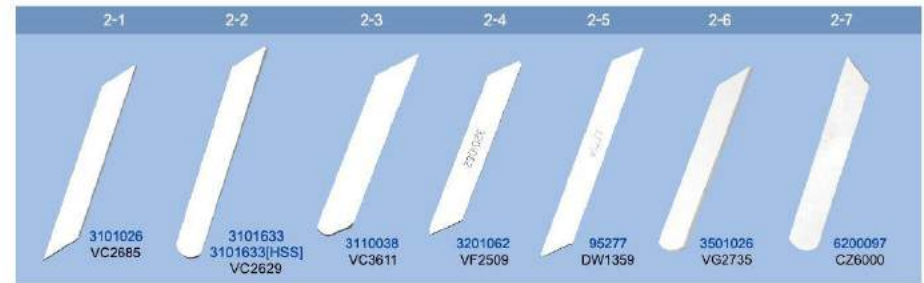
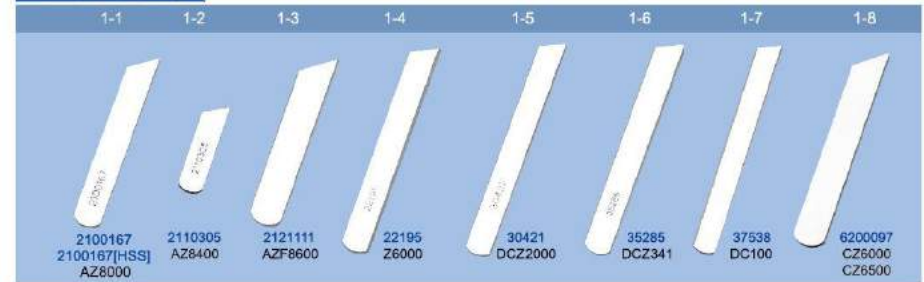



工业缝纫机刀类

KNIVES FOR INDUSTRIAL SEWING MACHINES

INDUSTRIAL SEWING MACHINE SPARE PARTS

FOR YAMATO/大和

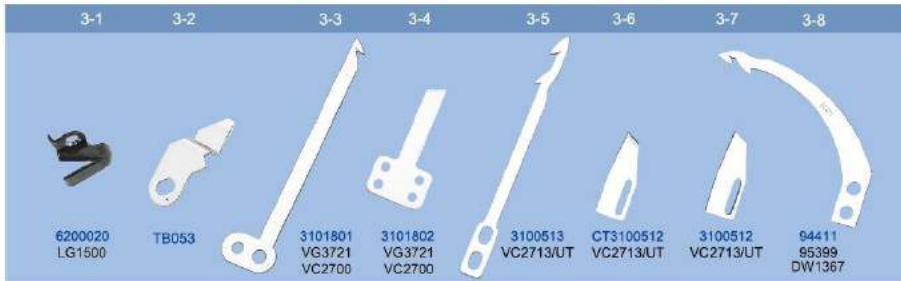

工业缝纫机刀类

KNIVES FOR INDUSTRIAL SEWING MACHINES

INDUSTRIAL SEWING MACHINE SPARE PARTS

FOR YAMATO/大和

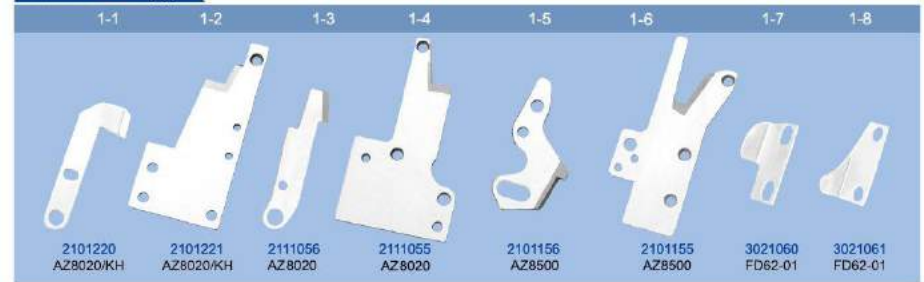

FOR NEWLONG/纽朗



FOR YAO HAN/耀翰



TAGS DICING CUTTER/吊牌切刀



LEATHER CUTTING KNIFE/割皮刀





工业缝纫机刀类

KNIVES FOR INDUSTRIAL SEWING MACHINES

INDUSTRIAL SEWING MACHINE SPARE PARTS

LEATHER CUTTING KNIFE/制皮刀

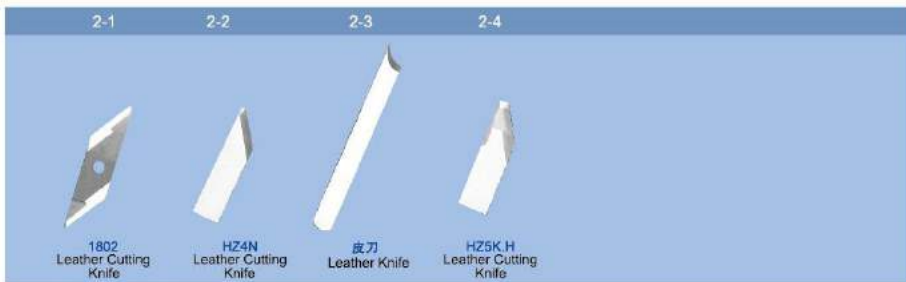
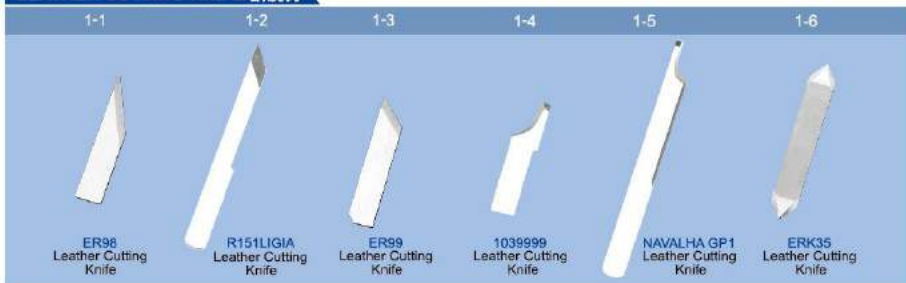

FOR OTHERS/其他

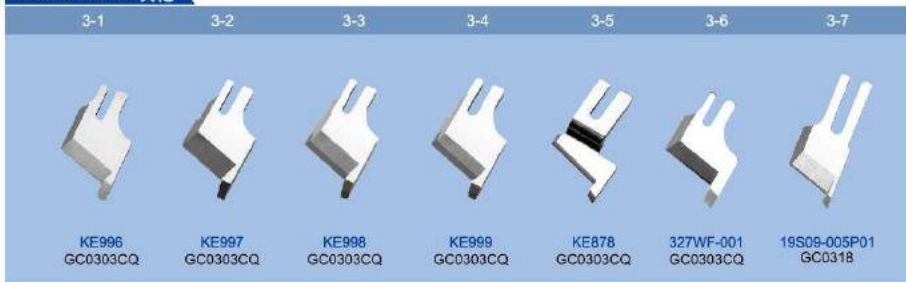

工业缝纫机刀类

KNIVES FOR INDUSTRIAL SEWING MACHINES

INDUSTRIAL SEWING MACHINE SPARE PARTS



FOR OTHERS/其他

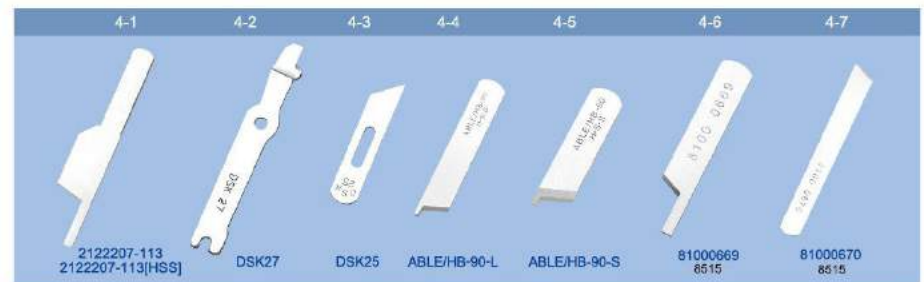
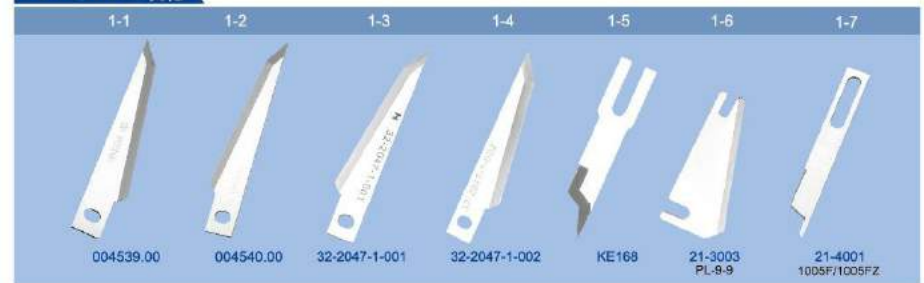



工业缝纫机刀类

KNIVES FOR INDUSTRIAL SEWING MACHINES

INDUSTRIAL SEWING MACHINE SPARE PARTS

FOR OTHERS/其他

1-1



613140

1-2



103-019
ACF-103N-3

1-3



103-002
ACF-103N-3

1-4



KE109

1-5



EH1644-OA

1-6



KE043

1-7



KE019

2-1



B4401

2-2



B4471

2-3



A105-21000

2-4



A105-31000

2-5



S.H

2-6



37231-033

2-7



KE004

3-1



2560
AK82800

3-2



2569
AK82800

3-3



10-5

3-4



10-4

3-5



ZS05

3-6



ZS04

3-7



114-023-000
LSM-150

3-8



16G-8

4-1



AF702
11702
AA

4-2



AF703
11703
AA

工业缝纫机刀类

KNIVES FOR INDUSTRIAL SEWING MACHINES

INDUSTRIAL SEWING MACHINE SPARE PARTS



FOR OTHERS/其他

1-1



DSGK209F0617

1-2



DSGK6390616

2-1



KE265
ACE

2-2



KE264
ACE



工业缝纫机刀类

KNIVES FOR INDUSTRIAL SEWING MACHINES

INDUSTRIAL SEWING MACHINE SPARE PARTS

FOR BROTHER/兄弟

1-1	1-2	1-3	1-4
S35436-001 DH4-B981 RH9820	S35436-001/M 特种钢材 Super material	S35437-001 DH4-B980	S35437-001/M 特种钢材 Super material

2-1	2-2	2-3
DH4-B980	B981 RH9820	S41345-001 RH9820

S35092-001	20m/m	S37703-001	14m/m
S37195-001	22m/m	S37704-001	16m/m
S37196-001	24m/m	S37705-001	18m/m
S37197-001	26m/m	S37706-001	20m/m
S37198-001	28m/m	S37707-001	22m/m
S37199-001	30m/m	S37708-001	24m/m
S35093-001	38m/m	S37709-001	26m/m
		S42053-001	28m/m
		S35479-001	50m/m

3-1	3-2	3-3
S41346-001 RH9820	S41347-001 RH9820	B980 RH9820

S37209-001	14m/m	S37198-001	28m/m
S37208-001	16m/m	S37199-001	30m/m
S37194-001	18m/m	S37200-001	32m/m
S35092-001	20m/m	S37201-001	34m/m
S37195-001	22m/m	S37202-001	36m/m
S37196-001	24m/m	S35093-001	38m/m
S37197-001	26m/m	SA7108-001	42m/m

FOR JUKI/重机

4-1	4-2	4-3
14041206 MEB-3200	14041206/M 特种钢材 Super material	MEB-3200

32063605	10m/m	32062705	26m/m
32063406	12m/m	32062606	28m/m
32063307	14m/m	32062507	30m/m
32063208	16m/m	32062408	32m/m
32063109	18m/m	32062309	34m/m
32063000	20m/m	32062200	36m/m
32062903	22m/m	32062101	38m/m
32062804	24m/m		

工业缝纫机刀类

KNIVES FOR INDUSTRIAL SEWING MACHINES

INDUSTRIAL SEWING MACHINE SPARE PARTS



FOR DURKOPP/杜克普

1-1	1-2	1-3	1-4	1-5	1-6
557 1677	558 2551 558	558 2561 558	558 2562 557	558 2562/M 特种钢材 Super material	558 2563 558

2-1	2-2	2-3	2-4	2-5	2-6
558 2564 558	558 2564/M 特种钢材 Super material	5783348 578	578 3363 578	578 3365 578	0580 330390 559

3-1	3-2	3-3	3-4	3-5
0580 330380 558	5783366	605340	548804	558

558 2406	18m/m
558 2407	20m/m
558 2408	22m/m
558 2409	24m/m
558 2410	26m/m
558 2411	28m/m
558 2412	30m/m
558 2413	34m/m
558 2414	38m/m

4-1	4-2
559	578

0580 330040	16m/m	578 3293	14m/m
0580 330050	18m/m	578 3284	16m/m
0580 330060	20m/m	578 3285	18m/m
0580 330070	22m/m	578 3286	20m/m
0580 330080	24m/m	578 3287	22m/m
0580 330090	26m/m	578 3288	24m/m
0580 330100	28m/m	578 3289	26m/m
0580 330110	30m/m	578 3290	28m/m
0580 330120	32m/m	578 3291	30m/m
0580 330130	34m/m	578 3292	32m/m
0580 330140	36m/m	578 3293	34m/m
0580 330150	38m/m	578 3294	36m/m



工业缝纫机刀类

KNIVES FOR INDUSTRIAL SEWING MACHINES

INDUSTRIAL SEWING MACHINE SPARE PARTS

FOR LSM/利华

1-1  1-2 

111-150-000	13mm
111-151-000	16mm
111-152-000	18mm
111-153-000	22mm
111-154-000	25mm
111-155-000	28mm
111-156-000	32mm

113-043-000
LSM-150

FOR REECE/利是

1-3  1-4 

10-3072-0-024
101

10-3072-0-024/M
特种钢材
Super material

2-1  2-2  2-3  2-4  2-5 

10-3072-0-014
101

10-3072-0-014/M
特种钢材
Super material

17-0064-5-864 3/5CA
100

17-0064-5-864 3/5CB
100

17-0064-5-863



3-1  3-2 

10-1069-0-051	7/8"
10-1069-0-052	1"
10-1069-0-054	1 1/4"
10-1069-0-055	1 3/8"
10-1069-0-056	1 1/2"
10-1069-0-060	2"

101

17-0084-5-951	13mm
17-0084-5-849	16mm
17-0084-5-852	22mm
17-0084-5-854	26mm
17-0084-5-855	29mm
17-0084-5-856	32mm
17-0084-5-858	38mm

100

4-1  4-2 

REECE10018MM
REECE10019MM
REECE10020MM
REECE10024MM
REECE10029MM
REECE10030MM
REECE10035MM

100

10-1069-0-001	1/2"
10-1069-0-002	5/8"
10-1069-0-003	3/4"
10-1069-0-004	7/8"
10-1069-0-005	1"
10-1069-0-006	1 1/8"
10-1069-0-007	1 1/4"

104

工业缝纫机刀类

KNIVES FOR INDUSTRIAL SEWING MACHINES

INDUSTRIAL SEWING MACHINE SPARE PARTS



FOR SINGER/胜家

1-1  1-2  1-3  1-4  1-5  1-6 

548936
299U253SW

544599
299U253SW

548886
299U253SW

548992
299U253SW

548935
299U253SW

255344
299U253SW

2-1  2-2  2-3  2-4  2-5 

548066
299U253SW

544600
299U253SW

544587	3/4
544588	7/8
544589	1

299U253SW

544593	5/8
544595	7/8
544596	1

299U253SW

548837	3/4
548838	7/8

299U253SW

3-1  3-2 



548762	1/2"
548763	5/8"
548764	3/4"
548765	7/8"
548766	1"
548767	1 1/8"
548768	1 1/4"
548769	1 3/8"
548770	1 1/2"
548771	1 5/8"

299U

548752	1/2"
548753	5/8"
548754	3/4"
548755	7/8"
548756	1"
548757	1 1/8"
548758	1 1/4"
548759	1 3/8"
548760	1 1/2"
548761	1 5/8"

299U

FOR JACK/杰克

4-1  4-2  4-3 

JK-T580-01-028-016
JK-580

JK-T580-01-28-017
JK-580

JK-T580-01-28-018
JK-580



KNIVES

for cutting machines
裁剪机系列刀类



2015-2016 Catalogue

裁断机圆刀 ROUND KNIVES FOR END CUTTER MACHINES

INDUSTRIAL SEWING MACHINE SPARE PARTS



FOR EASTMAN		FOR HITAKA		FOR HOOGS		FOR KM		
1-1	1-2	2-1	2-2	2-3	2-4	3-1	3-2	3-3
SIZE PART NO.	SIZE PART NO.	SIZE PART NO.	SIZE PART NO.	SIZE PART NO.	SIZE PART NO.	SIZE PART NO.	SIZE PART NO.	SIZE PART NO.
102×40×1.05 80C1-59 R4E	133×52×1.05 80C1-61 R5 1/4E	90×17.5×1.1 R31/2H	110×10×1.6 HOOG'S110(4)	50×10×1.2 RS-50 R2KM A-113(R)	50×10×1.2 RS-50(6) R2KM(6) A-113(6)	50×10×1.2 RS-50(7) R2KM(7) A-113(7)	100×21×1.2 RS-100	100×21×1.2 RS-100(8) R4KM(8) RCS-135(8)



裁断机圆刀

ROUND KNIVES FOR END CUTTER MACHINES

INDUSTRIAL SEWING MACHINE SPARE PARTS

FOR KM

1-1

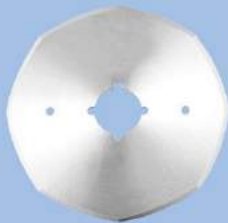

SIZE 110 × 21 × 1.3
PART NO. RS-110(8)

1-2

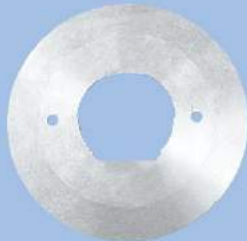

SIZE 127 × 43 × 1.2
PART NO. R5KM

1-3

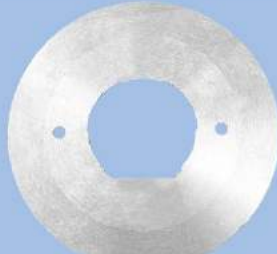

SIZE 152 × 50 × 1.5
PART NO. R6KM

FOR KURIS

2-1

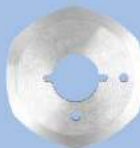

SIZE 50 × 16 × 1
PART NO. R16110(8)
24741
R2(8)KURIS

2-2



SIZE 50 × 16 × 1.0
PART NO. KE725(8)

2-3



SIZE 80 × 22 × 1
PART NO. R16092(6)
46377
BOM-80

2-4

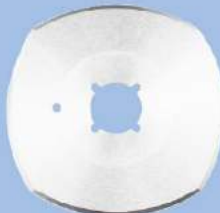

SIZE 100 × 22 × 1.0
PART NO. BOM-101(4)

FOR SUPRENA

3-1



SIZE 50 × 16 × 1
PART NO. MO702

3-2



SIZE 50 × 16 × 1
PART NO. MO700(6)

3-3



SIZE 50 × 16 × 1
PART NO. M0703(8)

3-4

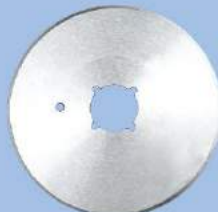

SIZE 100 × 22 × 1
PART NO. R1512

裁断机圆刀

ROUND KNIVES FOR END CUTTER MACHINES

INDUSTRIAL SEWING MACHINE SPARE PARTS



FOR SUPRENA

1-1

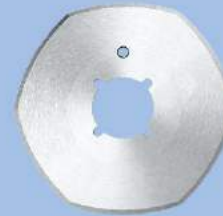

SIZE 100 × 22 × 1
PART NO. R1513(6)

FOR HOFFMANHF

1-2



SIZE 95.5 × 22.1 × 1.1
PART NO. HF100(5A)

1-3



SIZE 125.5 × 22.1 × 1.2
PART NO. HF125(5A)

GENERAL ROUND CORNER KNIFE/通用型圆角刀

2-1

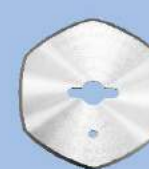

SIZE 65 × 10 × 1
PART NO. 65(6)(5A)

2-2

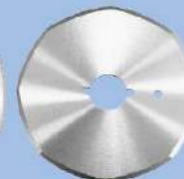

SIZE 70 × 16.5 × 1
PART NO. 70(8)(5A)

2-3

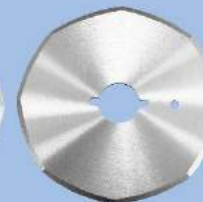

SIZE 90 × 18 × 1.2
PART NO. 90(8)(5A)

2-4

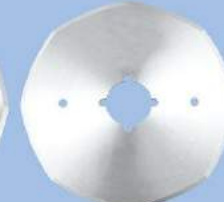

SIZE 100 × 21 × 1.2
PART NO. 100(8)(5A)

3-1

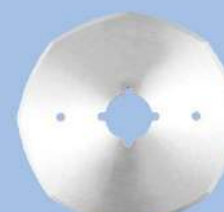

SIZE 110 × 21 × 1.3
PART NO. 110(8)(5A)

3-2



SIZE 125 × 21 × 1.2
PART NO. 125(8)(5A)



裁断机圆刀

ROUND KNIVES FOR END CUTTER MACHINES

INDUSTRIAL SEWING MACHINE SPARE PARTS

SPLITTING KNIFE/剖缝机刀

1-1

1-2

1-3

1-4

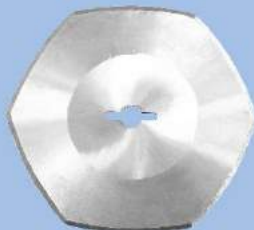
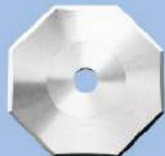

SIZE 65×10.9×0.65
PART NO. KE915(6)

SIZE 68×10×0.6
PART NO. KE919(8)

SIZE 68×10×1
PART NO. KE920(8)

SIZE 124.5×10.9×0.85
PART NO. KE918(8)

MANUAL DRIVE ROTARY CUTTER/手动轮刀

2-1

2-2

2-3



SIZE 28.5×5×0.3
PART NO. KE301

SIZE 45×8×0.3
PART NO. KE918

SIZE 60×10×0.3
PART NO. KE1033

FOR OTHERS/其他

3-1

3-2

3-3

3-4



SIZE 28×5×0.3
PART NO. BT113072(10)

SIZE 42×5.5×1
PART NO. KE492(10)

SIZE 49×13×1.1
PART NO. KE600(6)

SIZE 50×10×1.8
PART NO. KE817(7)

裁断机圆刀

ROUND KNIVES FOR END CUTTER MACHINES

INDUSTRIAL SEWING MACHINE SPARE PARTS



FOR OTHERS/其他

1-1

1-2

1-3

1-4

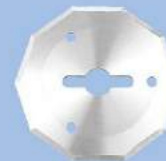

SIZE 59.5×10×1.4
PART NO. KE801(10)

SIZE 80×10×1.4
PART NO. KE801

SIZE 80×12×0.8
PART NO. MK-5D

SIZE 67×22.2×1
PART NO. SF833(4)

2-1

2-2

2-3

2-4

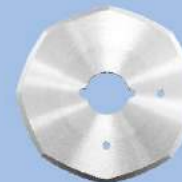

SIZE 70×16.5×1
PART NO. KE874(8)

SIZE 70×16.58×1.2
PART NO. KE172(8)

SIZE 70×40×1
PART NO. TK17(1 Convexity)

SIZE 70×40×1
PART NO. TK17(2 Convexity)

3-1

3-2

3-3

3-4



SIZE 80×40×1
PART NO. TK18

SIZE 80×10×1.3
PART NO. R46(4)

SIZE 89×17.5×1.1
PART NO. KE810(8)

SIZE 89×17.5×1.2
PART NO. KE888



裁断机圆刀

ROUND KNIVES FOR END CUTTER MACHINES

INDUSTRIAL SEWING MACHINE SPARE PARTS

FOR OTHERS/其他

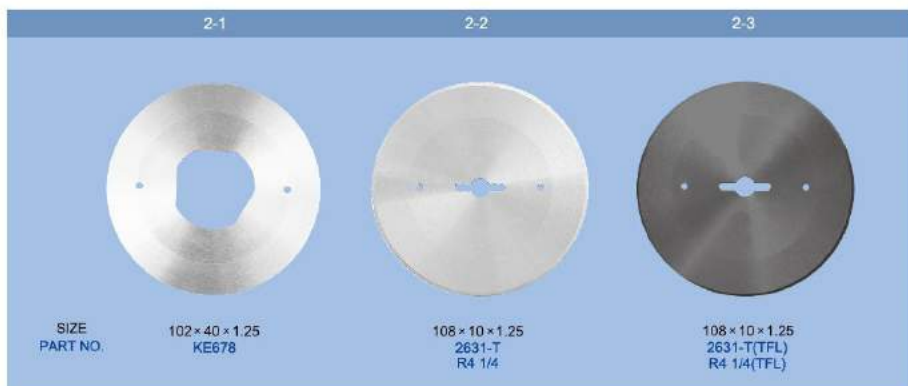
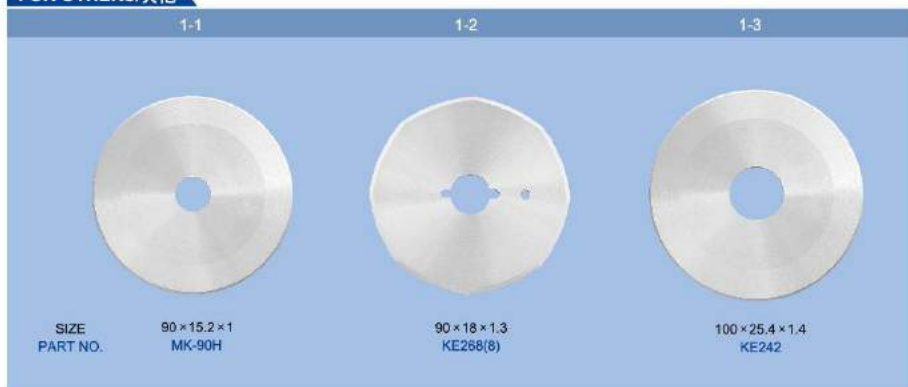

裁断机圆刀

ROUND KNIVES FOR END CUTTER MACHINES

INDUSTRIAL SEWING MACHINE SPARE PARTS



FOR OTHERS/其他

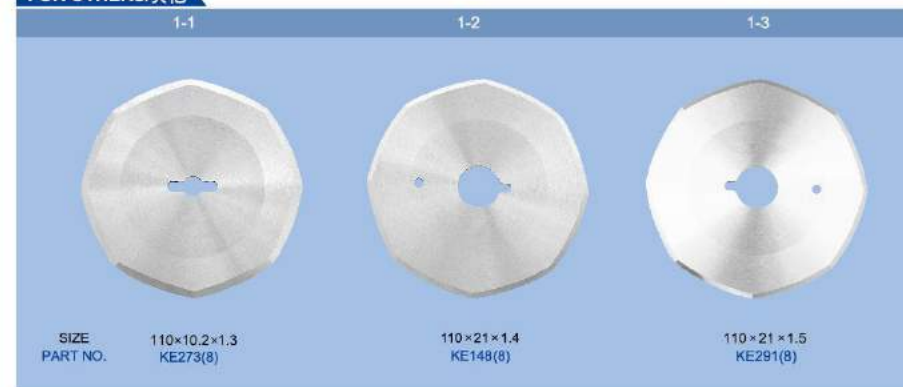

LOWER KNIVES FOR ROUND KNIFE



1-1



PART NO./品号	SIZE/规格	MATERIAL/材质
KE593	300×38.1×2.5	Alloy Steel/合金钢, Super Alloy Steel/特殊合金钢
KE594	300×38.1×2.8	Alloy Steel/合金钢, Super Alloy Steel/特殊合金钢
KE947	350×38.1×2.8	Alloy Steel/合金钢, Super Alloy Steel/特殊合金钢
KE940	405×25.4×3.175	Alloy Steel/合金钢, Super Alloy Steel/特殊合金钢
.....



	1-1	1-2	1-3	1-4
SIZE	62×22×8.5	62×22×8.5	62×22×8.5	62×22×7.5
PART NO.	801-1	801-2	802-1	802-2

	2-1	2-2	2-3	2-4
SIZE	71.6×15×4.5	71.6×15×4.5	72×15×4.5	72×15×4.5
PART NO.	911-1/933-1 B1-1	911-2/933-2 B1-2	72×16×4.3 901-1	72×16×4.3 901-2

	3-1	3-2	3-3	3-4
SIZE	73×14×4.4	73×14×4.4	67×16×3.3	67×19×3.3
PART NO.	TC-38-1	TC-38-2	KNIT-1	KNIT-2



CAD裁刀
CAD CUTTING KNIVES

INDUSTRIAL SEWING MACHINE SPARE PARTS

FOR BULLMER/艾斯特-奔马

1-1	
SIZE	95×6×2
PART NO.	109148
1-2	
SIZE	223×10×2.5
PART NO.	108065-S KE380
1-3	
SIZE	223×8×2.5
PART NO.	103986
1-4	
SIZE	223×10×2.5
PART NO.	105935 105935-B KE379

FOR GERBER/格柏

1-5	
SIZE	195×7.92×1.96
PART NO.	CK-05G 54782009 KE381
1-6	
SIZE	202×6.3×2.16
PART NO.	CK-17G KE383
1-7	
SIZE	206×7.9×1.95
PART NO.	CK-33G 85878000 KE382
1-8	
SIZE	255×8×2.35
PART NO.	CK-01G 21261011 KE384

CAD裁刀
CAD CUTTING KNIVES

INDUSTRIAL SEWING MACHINE SPARE PARTS



FOR FKARNA

1-1	
SIZE	245×8.3×2.5
PART NO.	KE585
1-2	
SIZE	291×8×2.45
PART NO.	KE535
1-3	
SIZE	291.5×8.2×2.5
PART NO.	KE767
1-4	
SIZE	292×8.0×2.5
PART NO.	25492 KE398
1-5	
SIZE	370×8.5×2.4
PART NO.	N09.002S101

FOR INVESTRONICA/艾维斯

1-6	
SIZE	187×8×1.93
PART NO.	CV-40
1-7	
SIZE	252×8.3×2.5
PART NO.	S70817-001 KE385
1-8	
SIZE	252×9.4×2.75
PART NO.	ISP05037 KE386



CAD裁刀

CAD CUTTING KNIVES

INDUSTRIAL SEWING MACHINE SPARE PARTS

FOR KURIS

1-1 
 SIZE 176×9.5×1.2
 PART NO. 73436

1-2 
 SIZE 178×10×2.5
 PART NO. 24306

1-3 
 SIZE 223×10.5×3
 PART NO. 68539

1-4 
 SIZE 227×9.5×2
 PART NO. 66878

1-5 
 SIZE 227×10.5×3
 PART NO. 47968

FOR LECTRA/力克

1-6 
 SIZE 88×5.5×1.5
 PART NO. 801420

1-7 
 SIZE 88.5×5.5×1.5
 PART NO. 801220
 KE387

1-8 
 SIZE 90×5.5×1.5
 PART NO. 801424

CAD裁刀

CAD CUTTING KNIVES

INDUSTRIAL SEWING MACHINE SPARE PARTS



FOR LECTRA/力克

1-1 
 SIZE 296×7.0×2.0
 PART NO. 801214
 CK-17L
 KE389

1-2 
 SIZE 296×7.0×3.0
 PART NO. CK-16L
 KE388

1-3 
 SIZE 296×8.5×2.4
 PART NO. 801227
 KE390

1-4 
 SIZE 305×8.5×2.4
 PART NO. 801438



1-5 
 SIZE 305×8.5×2.4
 PART NO. 801268
 801274
 KE391

1-6 
 SIZE 308×7×2
 PART NO. 801439



1-7 
 SIZE 308×7×2
 PART NO. 801345

1-8 
 SIZE 364×8.5×2.4
 PART NO. HQF0495
 KE394

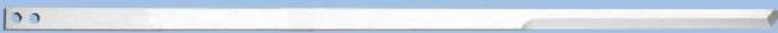
FOR LECTRA/力克

1-1	
SIZE	360 × 7.0 × 2.4
PART NO.	801222 CK-31L KE392
1-2	
SIZE	360 × 8.5 × 3.0
PART NO.	801217 KE393
1-3	
SIZE	365 × 8.5 × 2.4
PART NO.	801437
1-4	
SIZE	365 × 8.5 × 2.4
PART NO.	801269 KE395

FOR SHIMA SEIKI/岛精

1-5	
SIZE	173 × 8.0 × 2.5
PART NO.	KE263
1-6	
SIZE	212 × 8.0 × 2.3
PART NO.	KE293

FOR OTHERS/其他

1-1	
SIZE	101 × 7.9 × 1.6
PART NO.	CK-11T
1-2	
SIZE	110 × 7(6) × 2
PART NO.	KE557
1-3	
SIZE	128 × 6.9 × 1.95
PART NO.	KE277
1-4	
SIZE	182 × 8.2 × 1.96
PART NO.	13879800-1
1-5	
SIZE	195 × 7.9 × 1.96
PART NO.	KE266
1-6	
SIZE	223 × 10 × 3
PART NO.	KE189
1-7	
SIZE	245 × 8.3 × 2.5
PART NO.	KE497
1-8	
SIZE	255 × 8 × 1.95
PART NO.	KE547



钮门刀

BUTTON HOLE KNIVES

INDUSTRIAL SEWING MACHINE SPARE PARTS

FOR SINGER/胜家

1-1	1-2	1-3	1-4	1-5
71CL 1/4[A] 71CL 1/4[B] 1371A	71CL 5/16[A] 71CL 5/16[B] 1371A	71CL 3/8[A] 71CL 3/8[B] 1371A	71CL 7/16[A] 71CL 7/16[B] 1371A	71CL 1/2[A] 71CL 1/2[B] 1371A

2-1	2-2	2-3	2-4	2-5
71CL 9/16[A] 71CL 9/16[B] 1371A	71CL 5/8[A] 71CL 5/8[B] 1371A	71CL 3/4[A] 71CL 3/4[B] 1371A	71CL 7/8[A] 71CL 7/8[B] 1371A	71CL 1/8[A] 71CL 1/8[B] 1371A

3-1	3-2	3-3	3-4	3-5
71CL 1[A] 71CL 1[B] 1371A	71CL 11/16[A] 71CL 11/16[B] 1371A	71CL 1 1/8[A] 71CL 1 1/8[B] 1371A	71CL 1 1/4[A] 71CL 1 1/4[B] 1371A	71CL 1 3/8[A] 71CL 1 3/8[B] 1371A

4-1
71CL 1 1/2[A] 71CL 1 1/2[B] 1371A

裁剪机刀鞘

KNIFE SLIDE FOR CUTTING MACHINES

INDUSTRIAL SEWING MACHINE SPARE PARTS



FOR EASTMAN KNIVES SLIDE

1-1															
<table border="1"> <thead> <tr> <th>SIZE / 尺寸</th> <th>PART NO. / 品号</th> <th>MATERIAL / 材质</th> </tr> </thead> <tbody> <tr> <td>7"</td> <td>643C1-42</td> <td>Alloy Steel / 合金钢、HSS / 高速钢</td> </tr> <tr> <td>8"</td> <td>643C1-43</td> <td>Alloy Steel / 合金钢、HSS / 高速钢</td> </tr> <tr> <td>10"</td> <td>643C1-47</td> <td>Alloy Steel / 合金钢、HSS / 高速钢</td> </tr> <tr> <td>.....</td> <td>.....</td> <td>.....</td> </tr> </tbody> </table>	SIZE / 尺寸	PART NO. / 品号	MATERIAL / 材质	7"	643C1-42	Alloy Steel / 合金钢、HSS / 高速钢	8"	643C1-43	Alloy Steel / 合金钢、HSS / 高速钢	10"	643C1-47	Alloy Steel / 合金钢、HSS / 高速钢
SIZE / 尺寸	PART NO. / 品号	MATERIAL / 材质													
7"	643C1-42	Alloy Steel / 合金钢、HSS / 高速钢													
8"	643C1-43	Alloy Steel / 合金钢、HSS / 高速钢													
10"	643C1-47	Alloy Steel / 合金钢、HSS / 高速钢													
.....													

FOR KM KNIVES SLIDE

2-1																														
<table border="1"> <thead> <tr> <th>SIZE / 尺寸</th> <th>PART NO. / 品号</th> <th>MATERIAL / 材质</th> </tr> </thead> <tbody> <tr> <td>5"</td> <td>A4006-5H</td> <td>Alloy Steel / 合金钢、HSS / 高速钢</td> </tr> <tr> <td>6"</td> <td>A4006-6H</td> <td>Alloy Steel / 合金钢、HSS / 高速钢</td> </tr> <tr> <td>7"</td> <td>A4006-7H</td> <td>Alloy Steel / 合金钢、HSS / 高速钢</td> </tr> <tr> <td>8"</td> <td>A4006-8H</td> <td>Alloy Steel / 合金钢、HSS / 高速钢</td> </tr> <tr> <td>10"</td> <td>A4006-10H</td> <td>Alloy Steel / 合金钢、HSS / 高速钢</td> </tr> <tr> <td>11 1/2"</td> <td>A4006-11H</td> <td>Alloy Steel / 合金钢、HSS / 高速钢</td> </tr> <tr> <td>12"</td> <td>A4006-12H</td> <td>Alloy Steel / 合金钢、HSS / 高速钢</td> </tr> <tr> <td>13"</td> <td>A4006-13H</td> <td>Alloy Steel / 合金钢、HSS / 高速钢</td> </tr> <tr> <td>.....</td> <td>.....</td> <td>.....</td> </tr> </tbody> </table>	SIZE / 尺寸	PART NO. / 品号	MATERIAL / 材质	5"	A4006-5H	Alloy Steel / 合金钢、HSS / 高速钢	6"	A4006-6H	Alloy Steel / 合金钢、HSS / 高速钢	7"	A4006-7H	Alloy Steel / 合金钢、HSS / 高速钢	8"	A4006-8H	Alloy Steel / 合金钢、HSS / 高速钢	10"	A4006-10H	Alloy Steel / 合金钢、HSS / 高速钢	11 1/2"	A4006-11H	Alloy Steel / 合金钢、HSS / 高速钢	12"	A4006-12H	Alloy Steel / 合金钢、HSS / 高速钢	13"	A4006-13H	Alloy Steel / 合金钢、HSS / 高速钢
SIZE / 尺寸	PART NO. / 品号	MATERIAL / 材质																												
5"	A4006-5H	Alloy Steel / 合金钢、HSS / 高速钢																												
6"	A4006-6H	Alloy Steel / 合金钢、HSS / 高速钢																												
7"	A4006-7H	Alloy Steel / 合金钢、HSS / 高速钢																												
8"	A4006-8H	Alloy Steel / 合金钢、HSS / 高速钢																												
10"	A4006-10H	Alloy Steel / 合金钢、HSS / 高速钢																												
11 1/2"	A4006-11H	Alloy Steel / 合金钢、HSS / 高速钢																												
12"	A4006-12H	Alloy Steel / 合金钢、HSS / 高速钢																												
13"	A4006-13H	Alloy Steel / 合金钢、HSS / 高速钢																												
.....																												

FOR EASTMAN STRAIGHT KNIVES

1-1



PART NO./品号	MATERIAL/材质
5E	Alloy Steel/合金钢, Super Alloy Steel/特殊合金钢, HSS/高速钢
6E	Alloy Steel/合金钢, Super Alloy Steel/特殊合金钢, HSS/高速钢
7E	Alloy Steel/合金钢, Super Alloy Steel/特殊合金钢, HSS/高速钢
8E	Alloy Steel/合金钢, Super Alloy Steel/特殊合金钢, HSS/高速钢
9E	Alloy Steel/合金钢, Super Alloy Steel/特殊合金钢, HSS/高速钢
10E	Alloy Steel/合金钢, Super Alloy Steel/特殊合金钢, HSS/高速钢
11½E	Alloy Steel/合金钢, Super Alloy Steel/特殊合金钢, HSS/高速钢
12E	Alloy Steel/合金钢, Super Alloy Steel/特殊合金钢, HSS/高速钢
13E	Alloy Steel/合金钢, Super Alloy Steel/特殊合金钢, HSS/高速钢
15E	Alloy Steel/合金钢, Super Alloy Steel/特殊合金钢, HSS/高速钢

FOR KM STRAIGHT KNIVES

2-1

窄刀 (Narrow)



PART NO./品号	MATERIAL/材质
5KM(N)	Alloy Steel/合金钢, Super Alloy Steel/特殊合金钢, HSS/高速钢
6KM(N)	Alloy Steel/合金钢, Super Alloy Steel/特殊合金钢, HSS/高速钢



PART NO./品号	MATERIAL/材质
5KM	Alloy Steel/合金钢, Super Alloy Steel/特殊合金钢, HSS/高速钢
6KM	Alloy Steel/合金钢, Super Alloy Steel/特殊合金钢, HSS/高速钢
7KM	Alloy Steel/合金钢, Super Alloy Steel/特殊合金钢, HSS/高速钢
8KM	Alloy Steel/合金钢, Super Alloy Steel/特殊合金钢, HSS/高速钢
9KM	Alloy Steel/合金钢, Super Alloy Steel/特殊合金钢, HSS/高速钢
10KM	Alloy Steel/合金钢, Super Alloy Steel/特殊合金钢, HSS/高速钢
11½KM	Alloy Steel/合金钢, Super Alloy Steel/特殊合金钢, HSS/高速钢
12KM	Alloy Steel/合金钢, Super Alloy Steel/特殊合金钢, HSS/高速钢
13KM	Alloy Steel/合金钢, Super Alloy Steel/特殊合金钢, HSS/高速钢
15KM	Alloy Steel/合金钢, Super Alloy Steel/特殊合金钢, HSS/高速钢

FOR TEFLON STRAIGHT KNIVES

3-1



PART NO./品号	MATERIAL/材质
8E(TFL)	Super Alloy Steel/特殊合金钢, HSS/高速钢
10E(TFL)	Super Alloy Steel/特殊合金钢, HSS/高速钢
12E(TFL)	Super Alloy Steel/特殊合金钢, HSS/高速钢

FOR EASTMAN WAVE KNIVES

1-1



PART NO./品号	MATERIAL/材质
5EW	Alloy Steel/合金钢, Super Alloy Steel/特殊合金钢, HSS/高速钢
6EW	Alloy Steel/合金钢, Super Alloy Steel/特殊合金钢, HSS/高速钢
7EW	Alloy Steel/合金钢, Super Alloy Steel/特殊合金钢, HSS/高速钢
8EW	Alloy Steel/合金钢, Super Alloy Steel/特殊合金钢, HSS/高速钢
9EW	Alloy Steel/合金钢, Super Alloy Steel/特殊合金钢, HSS/高速钢
10EW	Alloy Steel/合金钢, Super Alloy Steel/特殊合金钢, HSS/高速钢
12EW	Alloy Steel/合金钢, Super Alloy Steel/特殊合金钢, HSS/高速钢
13EW	Alloy Steel/合金钢, Super Alloy Steel/特殊合金钢, HSS/高速钢



深波浪
DEEP WAVE

PART NO./品号	MATERIAL/材质
6EW(KO)	Alloy Steel/合金钢, Super Alloy Steel/特殊合金钢, HSS/高速钢
7EW(KO)	Alloy Steel/合金钢, Super Alloy Steel/特殊合金钢, HSS/高速钢
8EW(KO)	Alloy Steel/合金钢, Super Alloy Steel/特殊合金钢, HSS/高速钢
9EW(KO)	Alloy Steel/合金钢, Super Alloy Steel/特殊合金钢, HSS/高速钢
10EW(KO)	Alloy Steel/合金钢, Super Alloy Steel/特殊合金钢, HSS/高速钢
12EW(KO)	Alloy Steel/合金钢, Super Alloy Steel/特殊合金钢, HSS/高速钢

FOR KM WAVE KNIVES

2-1



PART NO./品号	MATERIAL/材质
5KMW(N)	Alloy Steel/合金钢, Super Alloy Steel/特殊合金钢, HSS/高速钢
6KMW(N)	Alloy Steel/合金钢, Super Alloy Steel/特殊合金钢, HSS/高速钢



PART NO./品号	MATERIAL/材质
6KMW	Alloy Steel/合金钢, Super Alloy Steel/特殊合金钢, HSS/高速钢
7KMW	Alloy Steel/合金钢, Super Alloy Steel/特殊合金钢, HSS/高速钢
8KMW	Alloy Steel/合金钢, Super Alloy Steel/特殊合金钢, HSS/高速钢
9KMW	Alloy Steel/合金钢, Super Alloy Steel/特殊合金钢, HSS/高速钢
10KMW	Alloy Steel/合金钢, Super Alloy Steel/特殊合金钢, HSS/高速钢

FOR EASTMAN INNER PARTS

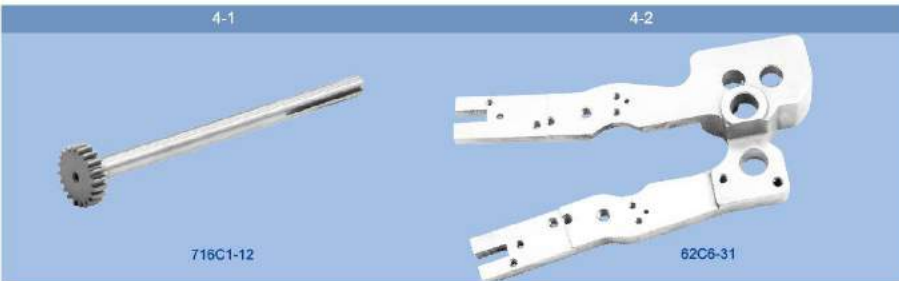

FOR EASTMAN INNER PARTS

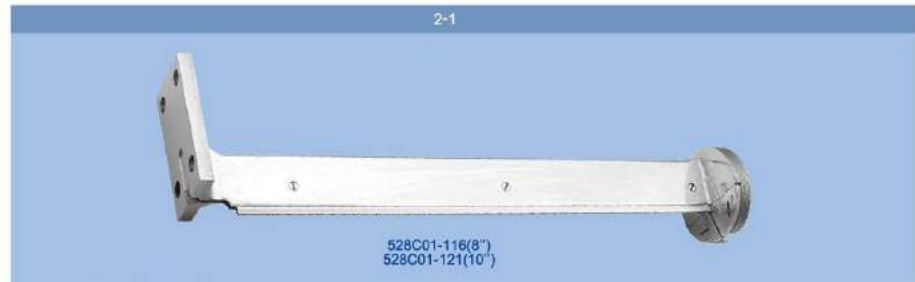
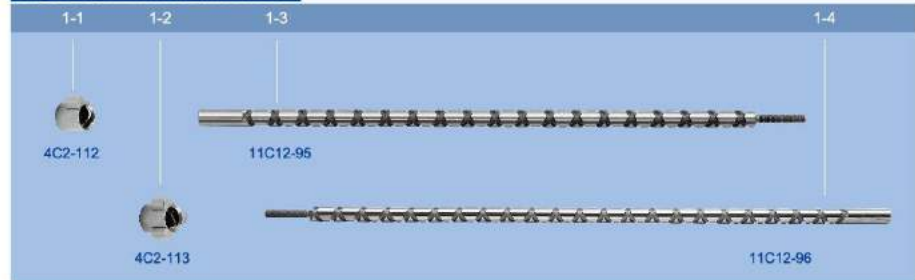

FOR KM INNER PARTS





钢带刀

BAND KNIVES

INDUSTRIAL SEWING MACHINE SPARE PARTS

1-1

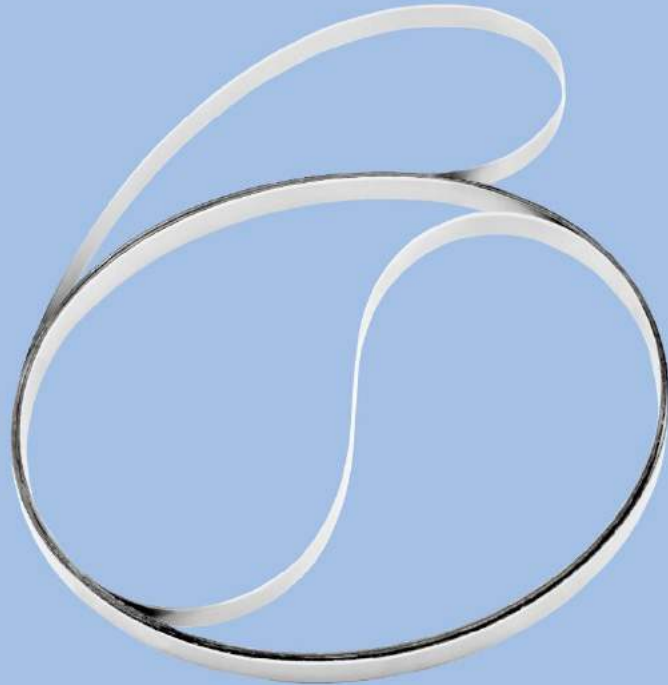

2000x10x0.45	3250x10x0.45	4000x10x0.45	4450x10x0.45	4920x10x0.45
2450x10x0.45	3400x10x0.45	4100x10x0.45	4460x10x0.45	5030x10x0.45
2500x10x0.45	3500x10x0.45	4120x10x0.45	4500x10x0.45	5050x10x0.45
2600x10x0.45	3600x10x0.45	4130x10x0.45	4530x10x0.45	5200x10x0.45
2800x10x0.45	3700x10x0.45	4150x10x0.45	4550x10x0.45	5250x10x0.45
3000x10x0.45	3750x10x0.45	4200x10x0.45	4555x10x0.45	5250x16x0.45
3050x10x0.45	3760x10x0.45	4240x10x0.45	4560x10x0.45	5270x10x0.45
3100x10x0.45	3795x10x0.45	4350x10x0.45	4600x10x0.45	5300x10x0.45
3110x10x0.45	3850x10x0.45	4400x10x0.45	4620x10x0.45	5730x16x0.45
3150x10x0.45	3860x10x0.45	4410x10x0.45	4700x10x0.45	5750x16x0.45
3200x10x0.45	3900x10x0.45	4430x10x0.45	4745x10x0.45
3240x10x0.45	3960x10x0.45	4435x10x0.45	4900x10x0.45

片皮机刀

SKIVING BAND KNIVES

INDUSTRIAL SEWING MACHINE SPARE PARTS



1-1

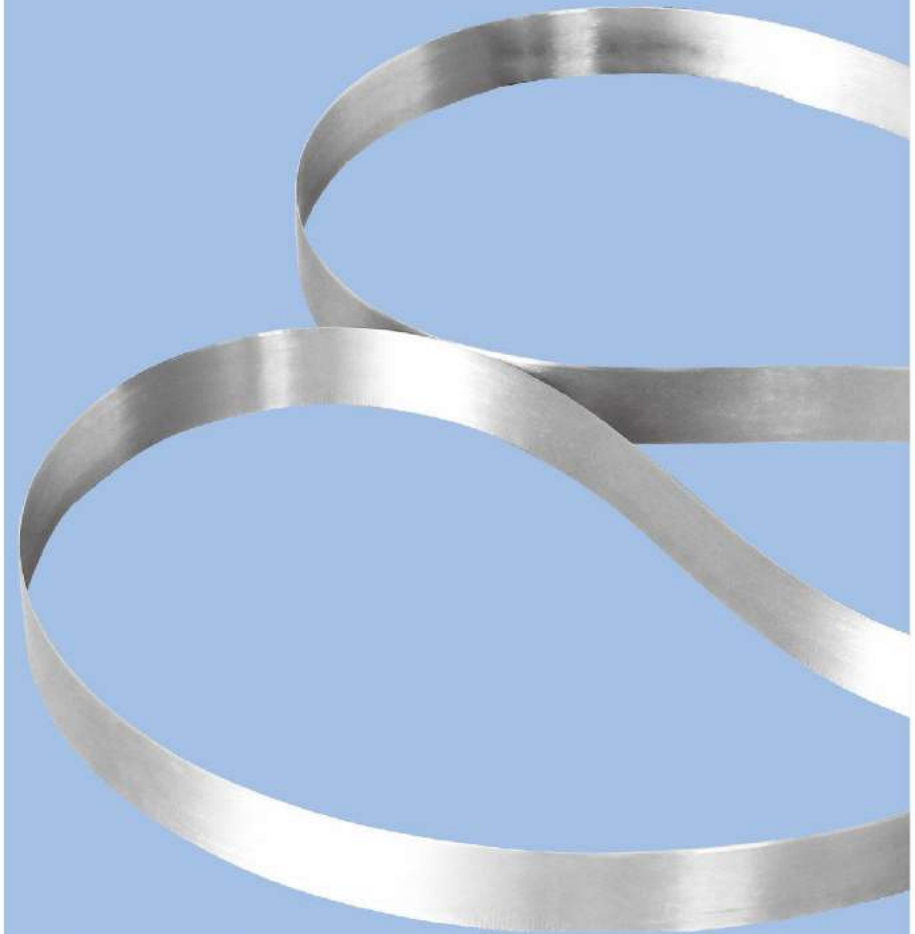

2065x40x0.5	3570x50x0.8
2590x40x0.5	3690x50x0.8
2662x50x0.6	3700x50x0.8
2695x50x0.6	3750x50x0.8
2790x50x0.6	3800x50x0.8
3350x50x0.6	3820x50x0.8
3500x50x0.7



KNIVES

for computerized embroidery machines
电脑绣花机刀类



2015-2016 Catalogue

电脑绣花机剪线刀类
COMPUTERIZED EMBROIDERY CUTTER
INDUSTRIAL SEWING MACHINE SPARE PARTS



FOR TAJIMA/田岛

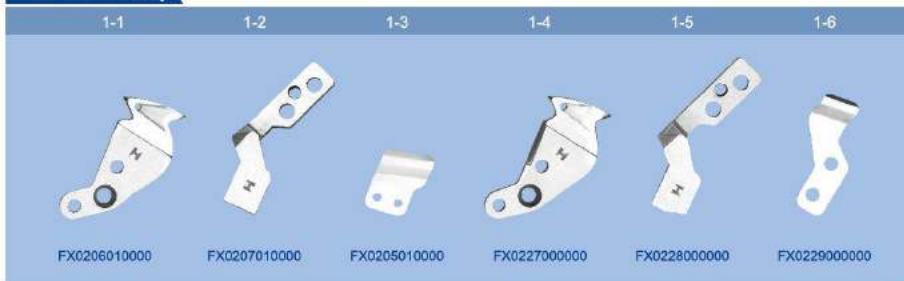

FOR PFAFF/百福

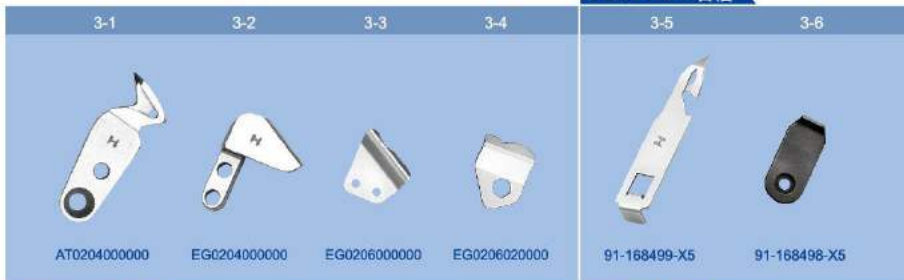

FOR SWF/伸势达



FOR HAPPY

FOR ZSK

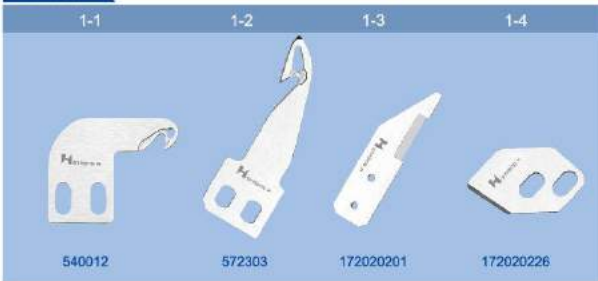

FOR BARUDAN/百灵达



FOR OTHERS/其他



FOR SWF/伸势达

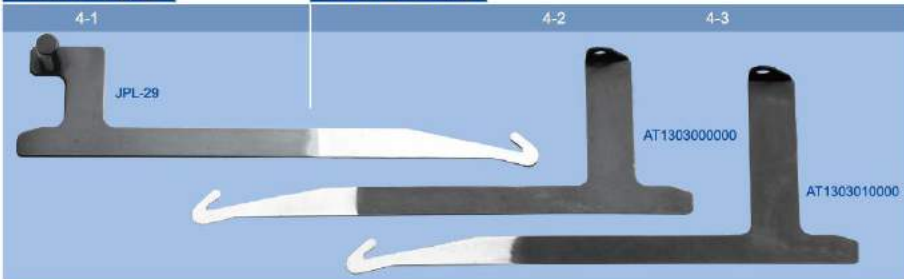

FOR TAJIMA/田岛



FOR SWF/伸势达

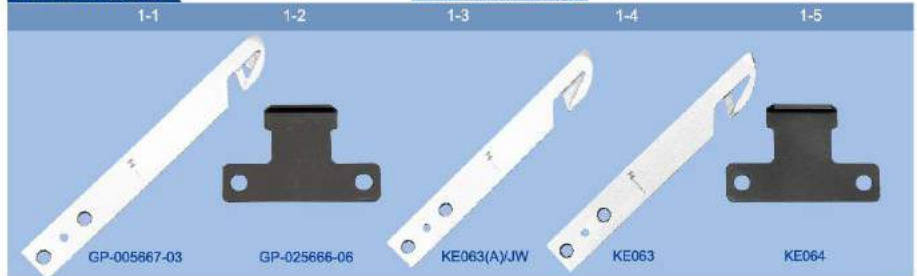

FOR TAJIMA/田岛

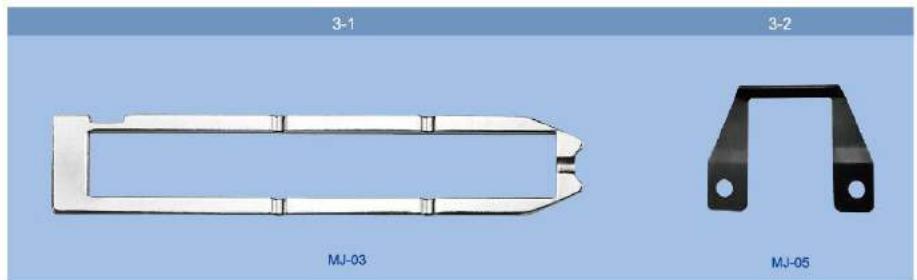



电脑绣花机附亮片绣刀类
KNIVES FOR COMPUTERIZED SEQUIN EMBROIDERY MACHINES
INDUSTRIAL SEWING MACHINE SPARE PARTS

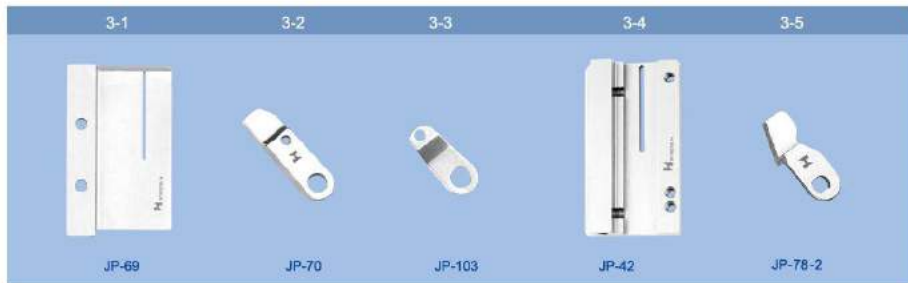
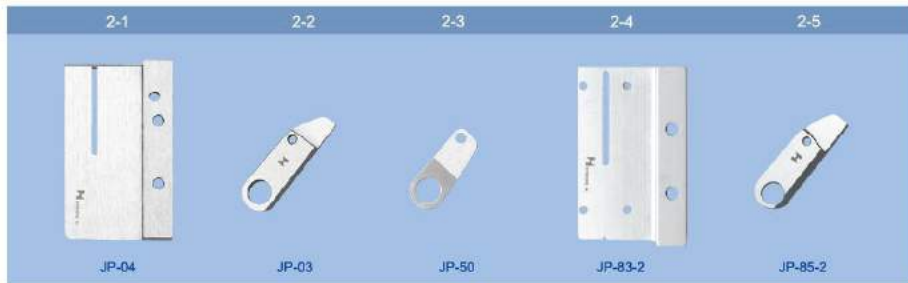
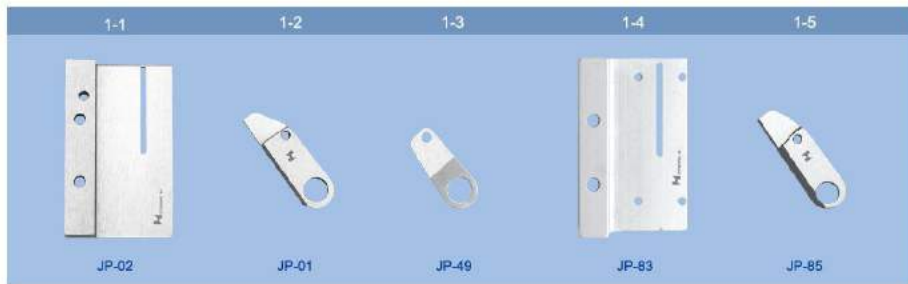

电脑绣花机附亮片绣刀类
KNIVES FOR COMPUTERIZED SEQUIN EMBROIDERY MACHINES
INDUSTRIAL SEWING MACHINE SPARE PARTS

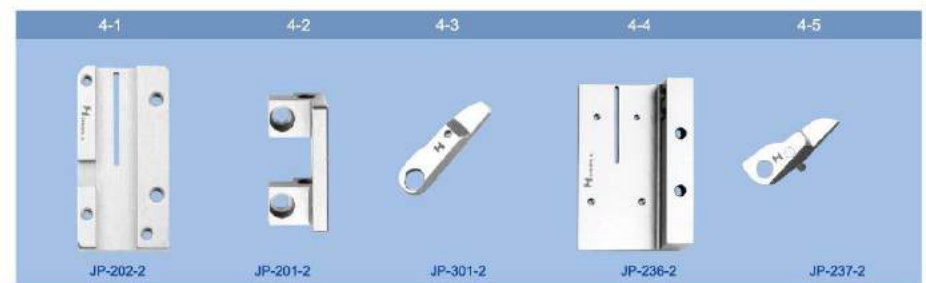
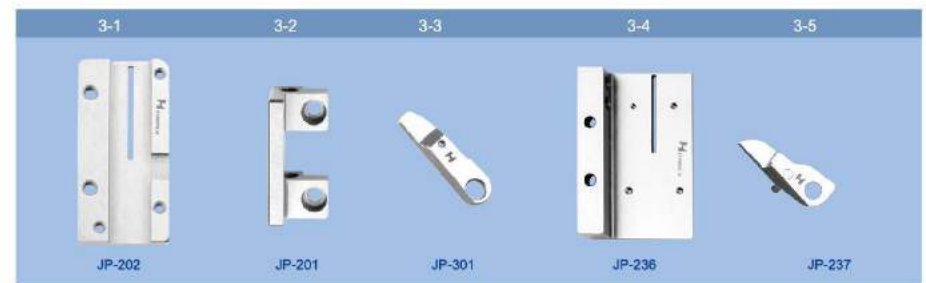
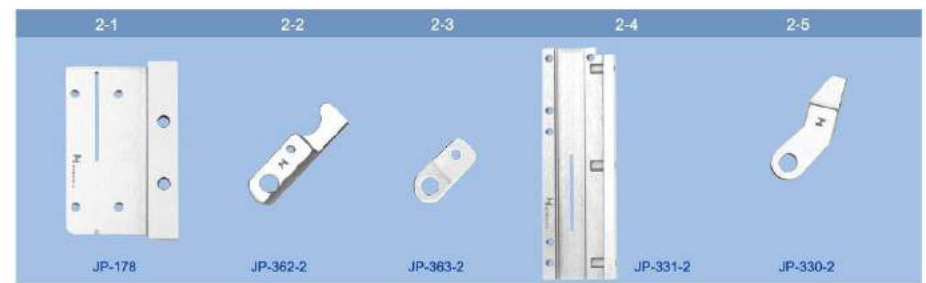



电脑绣花机附亮片绣刀类
KNIVES FOR COMPUTERIZED SEQUIN EMBROIDERY MACHINES
INDUSTRIAL SEWING MACHINE SPARE PARTS

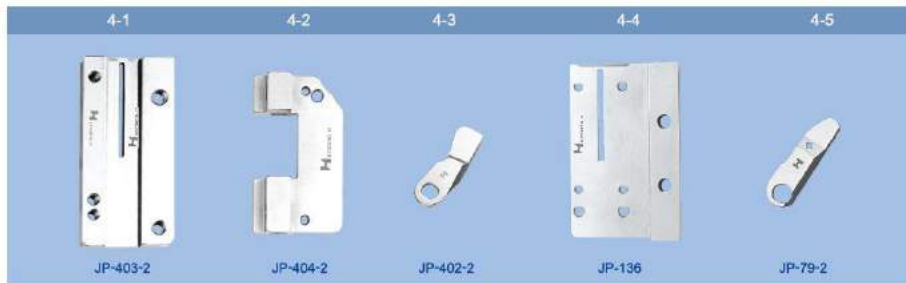
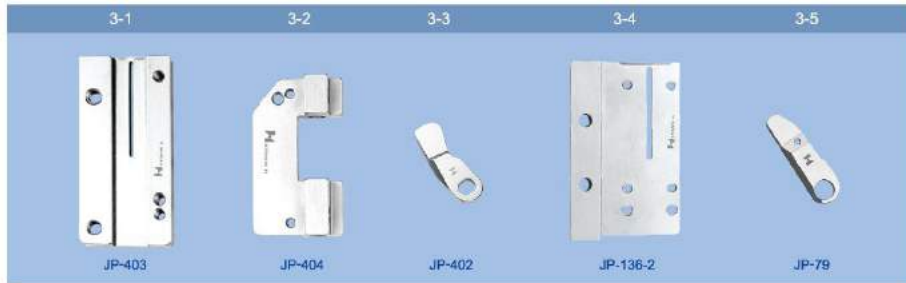
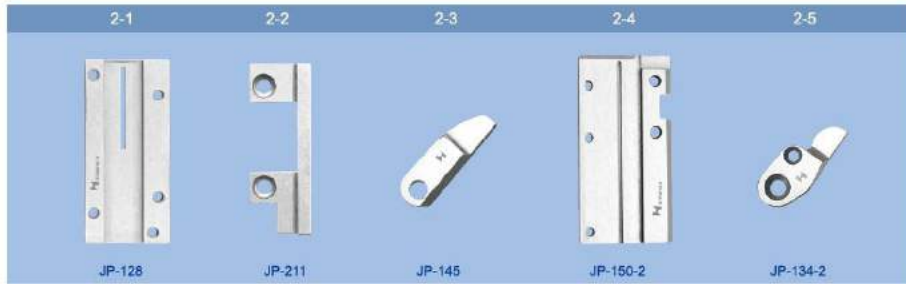
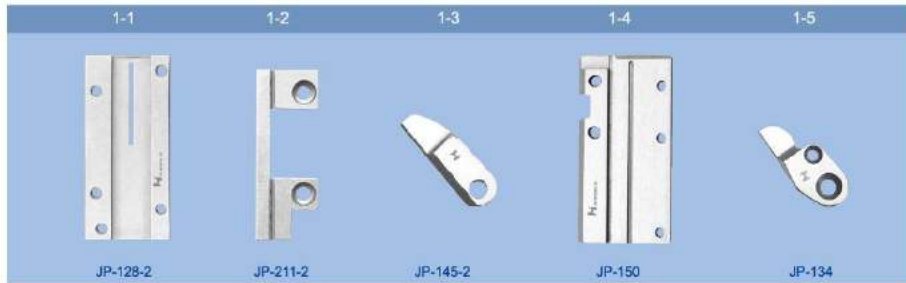

电脑绣花机附亮片绣刀类
KNIVES FOR COMPUTERIZED SEQUIN EMBROIDERY MACHINES
INDUSTRIAL SEWING MACHINE SPARE PARTS

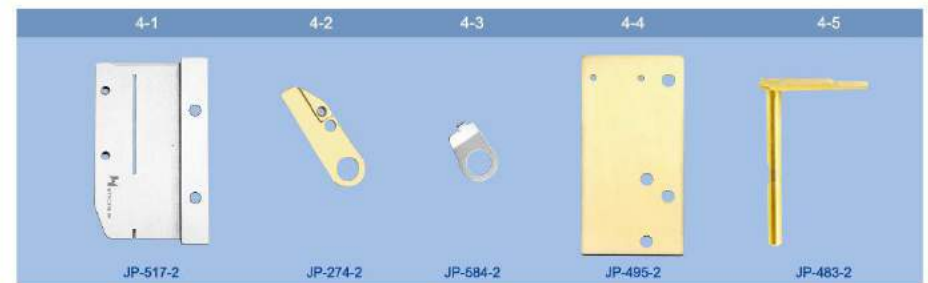



电脑绣花机附亮片绣刀类
KNIVES FOR COMPUTERIZED SEQUIN EMBROIDERY MACHINES
INDUSTRIAL SEWING MACHINE SPARE PARTS

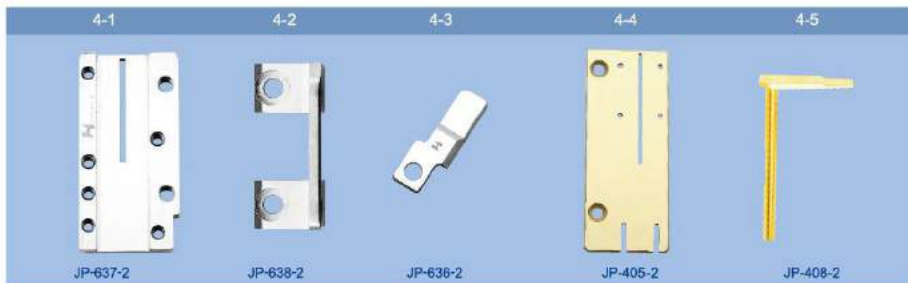
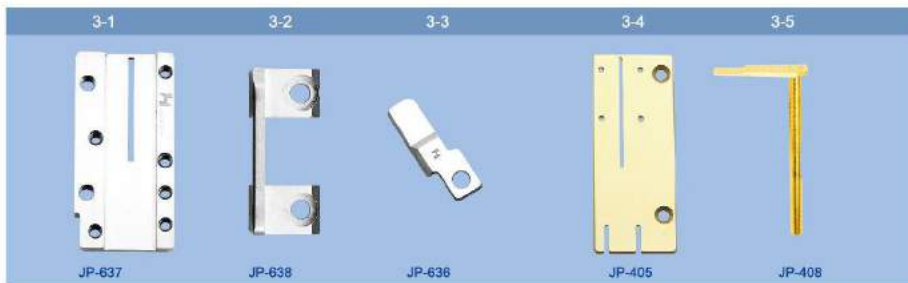
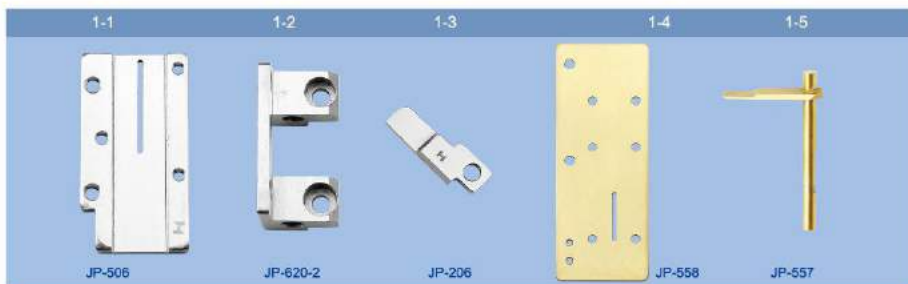

电脑绣花机附亮片绣刀类
KNIVES FOR COMPUTERIZED SEQUIN EMBROIDERY MACHINES
INDUSTRIAL SEWING MACHINE SPARE PARTS

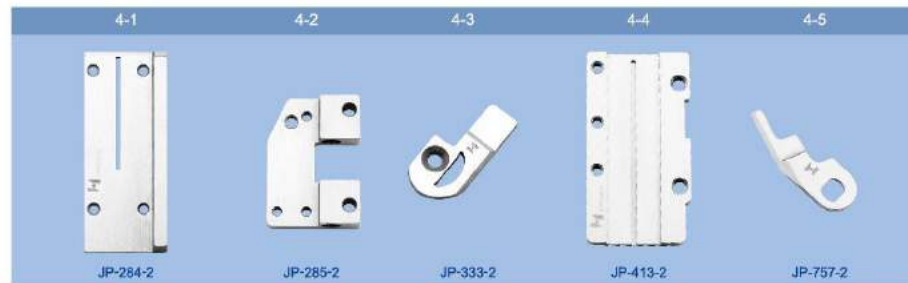
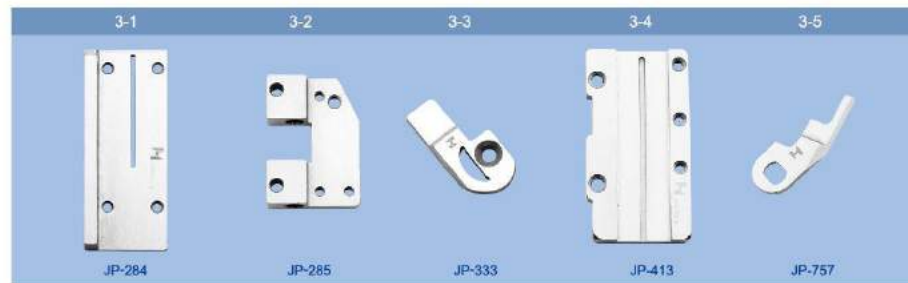
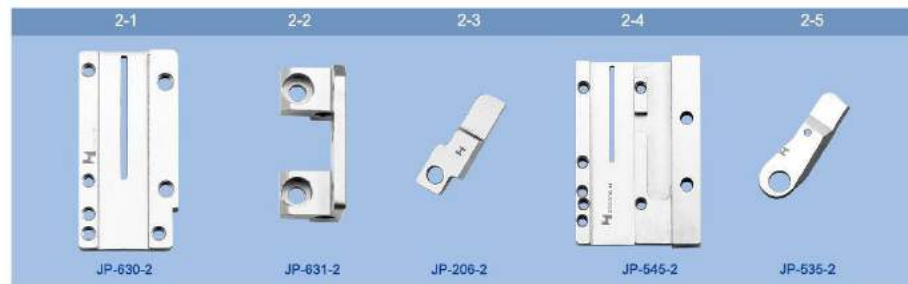
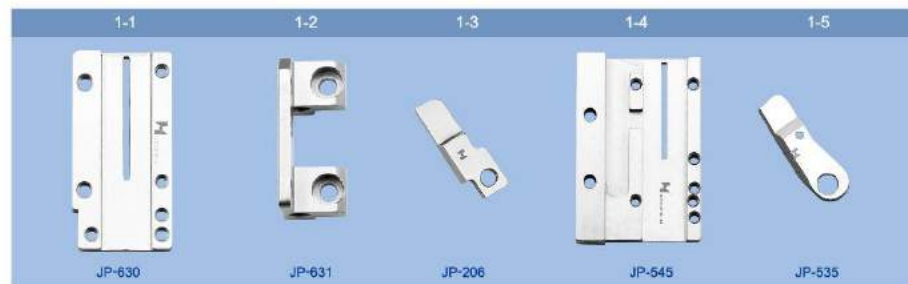



电脑绣花机附亮片绣刀类
KNIVES FOR COMPUTERIZED SEQUIN EMBROIDERY MACHINES
INDUSTRIAL SEWING MACHINE SPARE PARTS

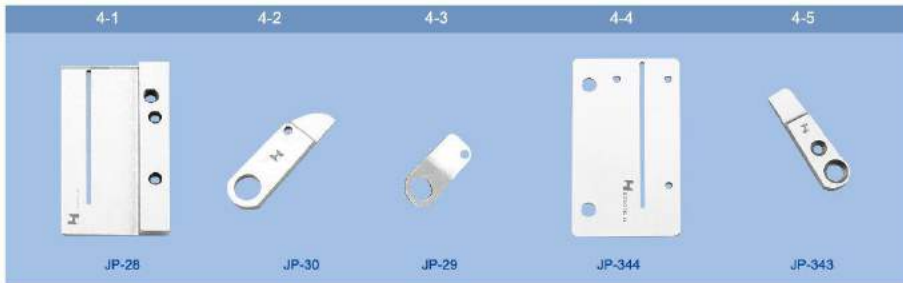
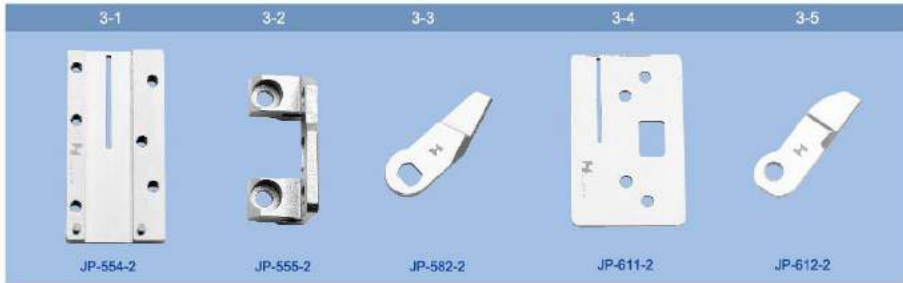
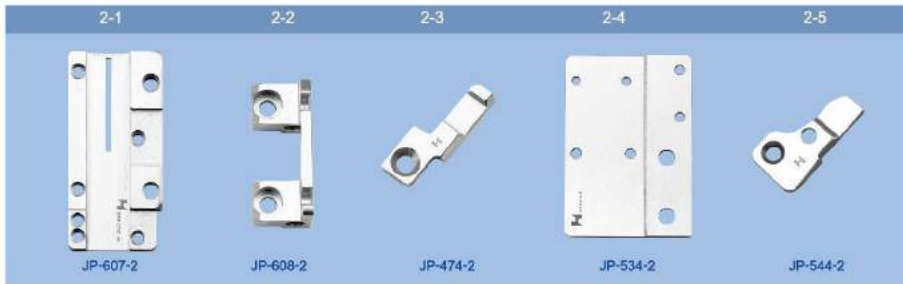

电脑绣花机附亮片绣刀类
KNIVES FOR COMPUTERIZED SEQUIN EMBROIDERY MACHINES
INDUSTRIAL SEWING MACHINE SPARE PARTS

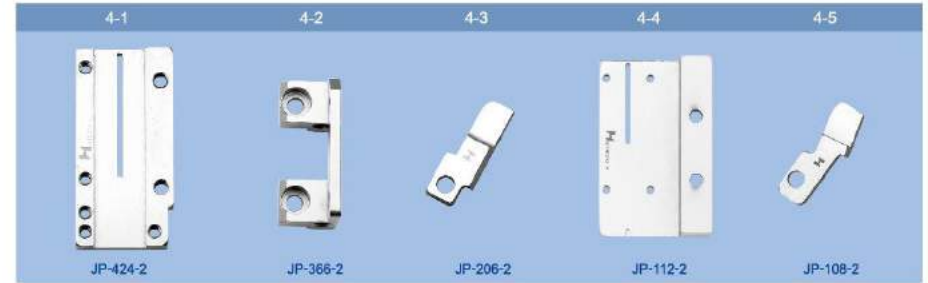
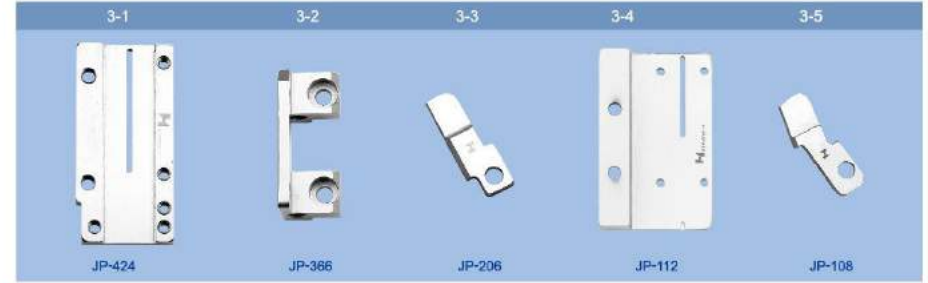
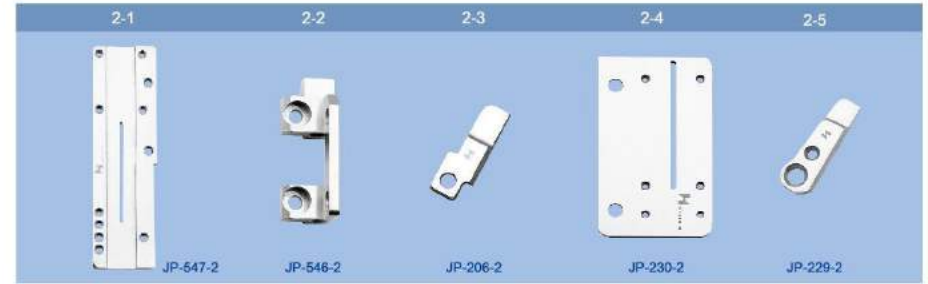
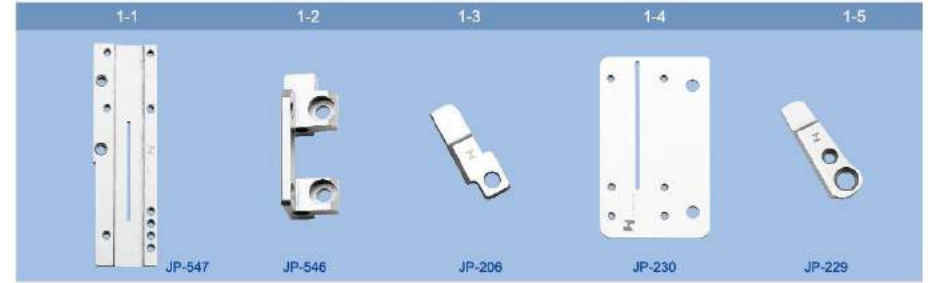



电脑绣花机附亮片绣刀类
KNIVES FOR COMPUTERIZED SEQUIN EMBROIDERY MACHINES
INDUSTRIAL SEWING MACHINE SPARE PARTS

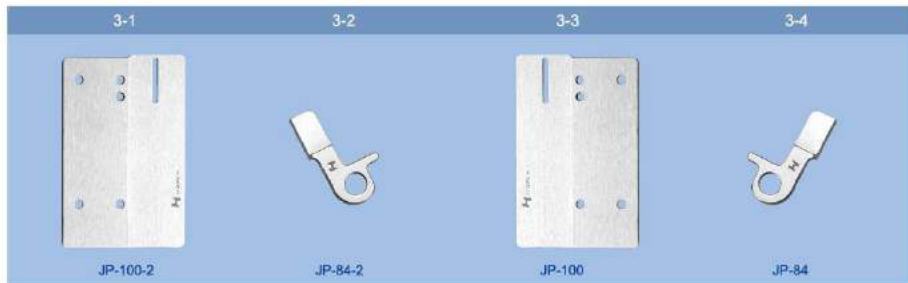
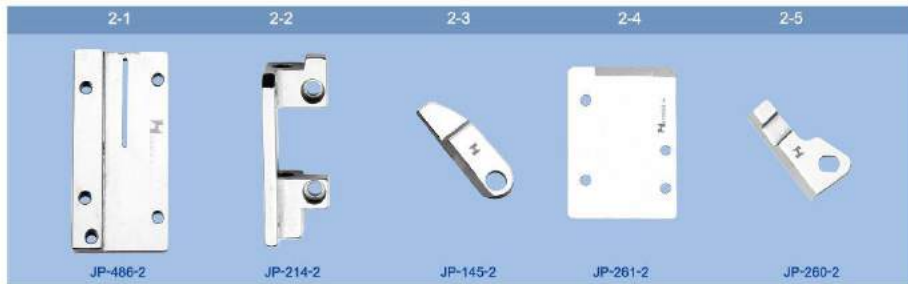
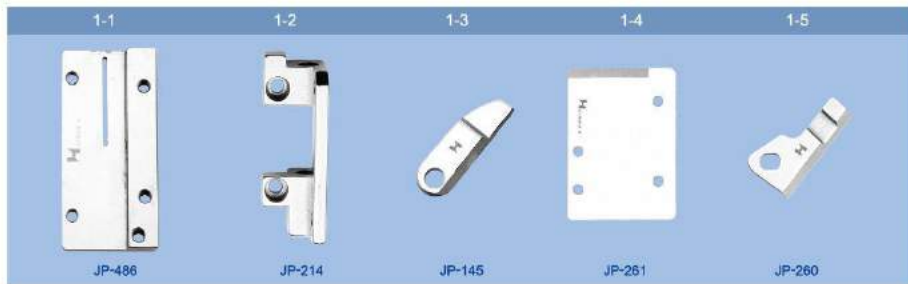

电脑绣花机附亮片绣刀类
KNIVES FOR COMPUTERIZED SEQUIN EMBROIDERY MACHINES
INDUSTRIAL SEWING MACHINE SPARE PARTS

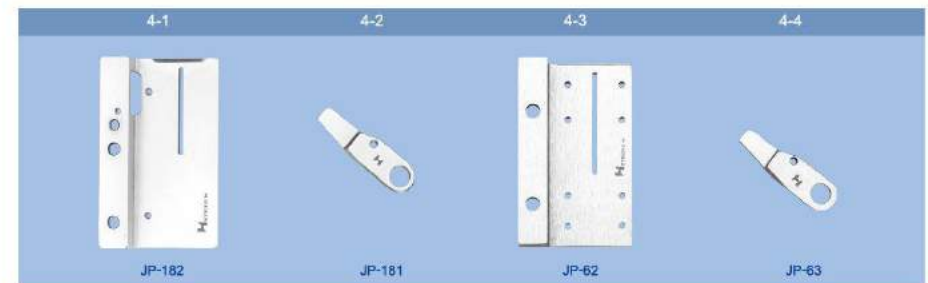
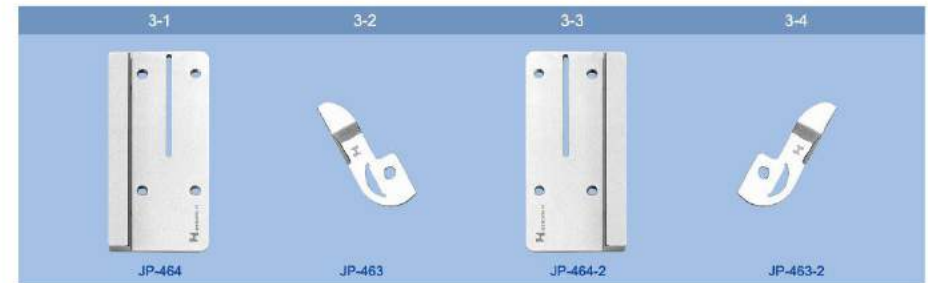
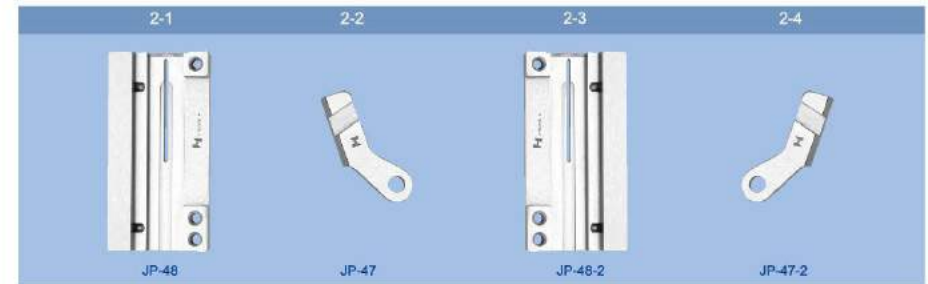
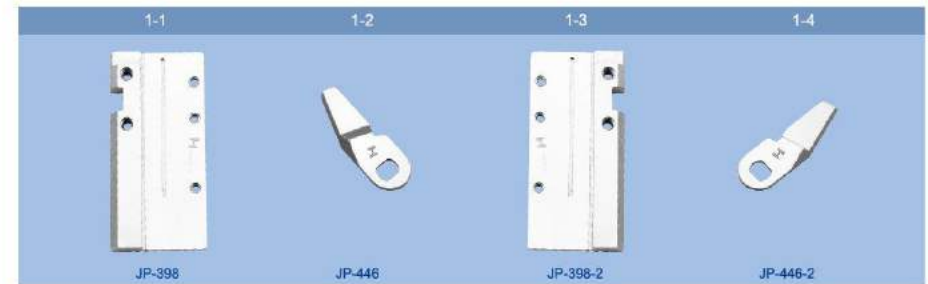



电脑绣花机附亮片绣刀类

KNIVES FOR COMPUTERIZED SEQUIN EMBROIDERY MACHINES

INDUSTRIAL SEWING MACHINE SPARE PARTS

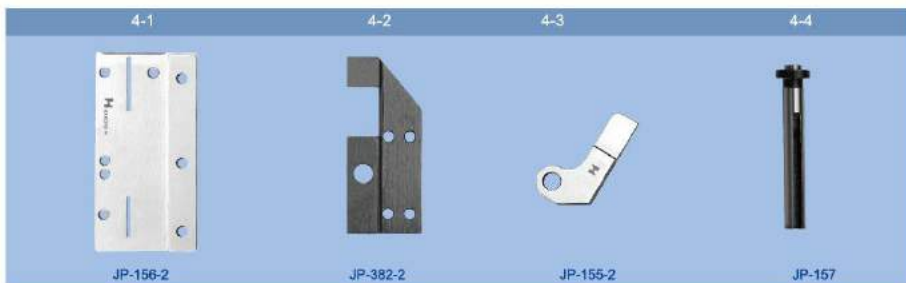
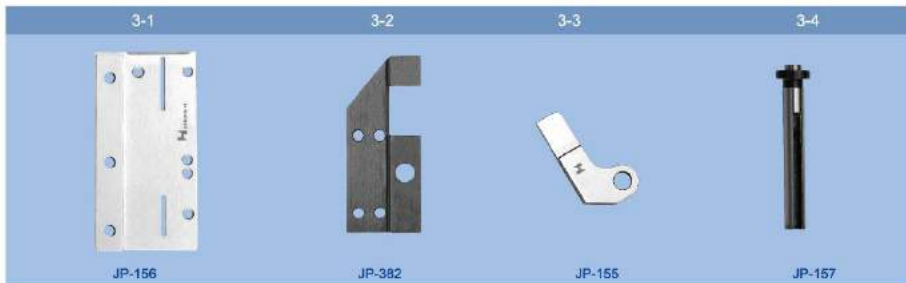
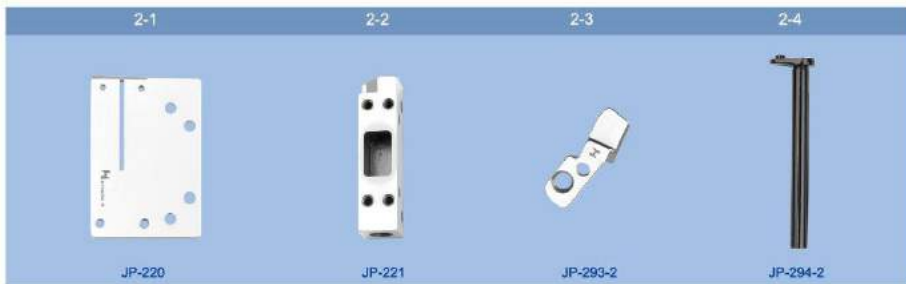
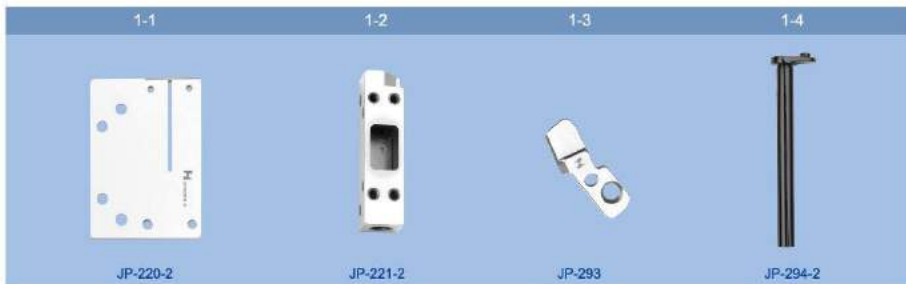

电脑绣花机附亮片绣刀类

KNIVES FOR COMPUTERIZED SEQUIN EMBROIDERY MACHINES

INDUSTRIAL SEWING MACHINE SPARE PARTS

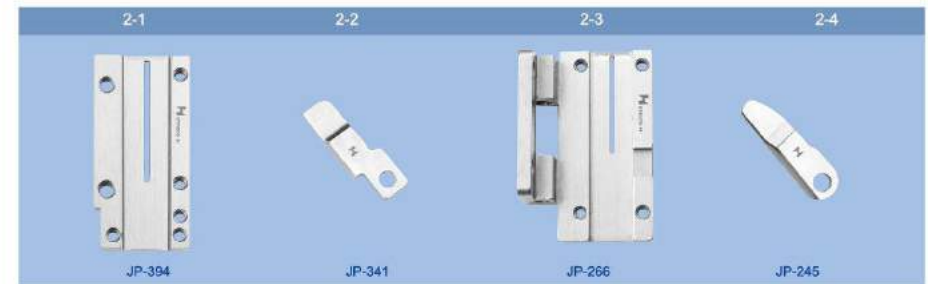



电脑绣花机附亮片绣刀类
KNIVES FOR COMPUTERIZED SEQUIN EMBROIDERY MACHINES
INDUSTRIAL SEWING MACHINE SPARE PARTS

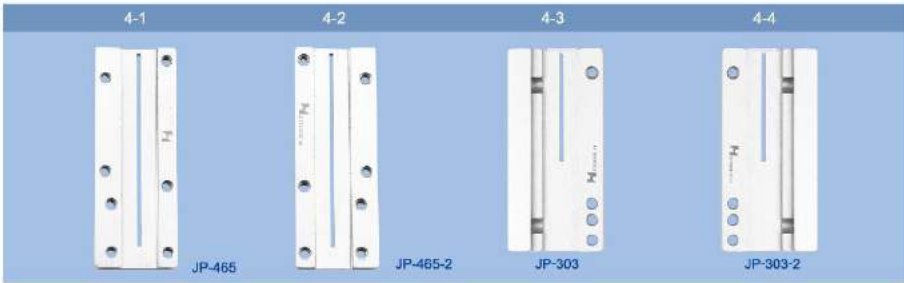
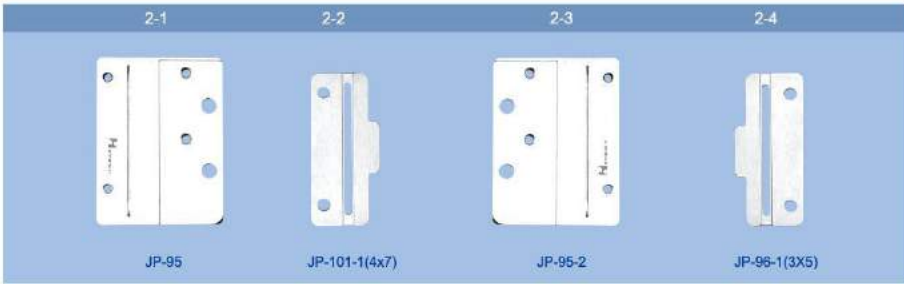

电脑绣花机附亮片绣刀类
KNIVES FOR COMPUTERIZED SEQUIN EMBROIDERY MACHINES
INDUSTRIAL SEWING MACHINE SPARE PARTS

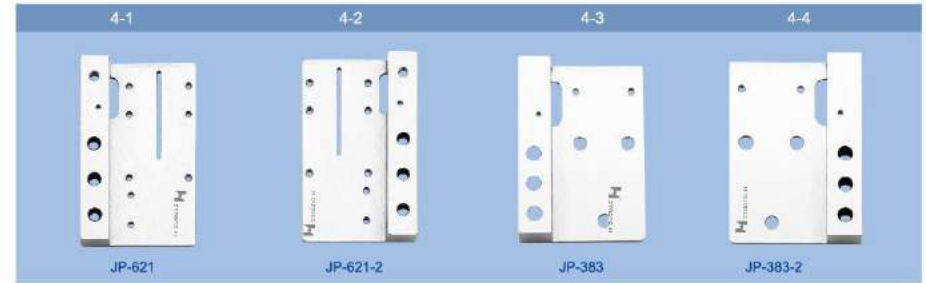
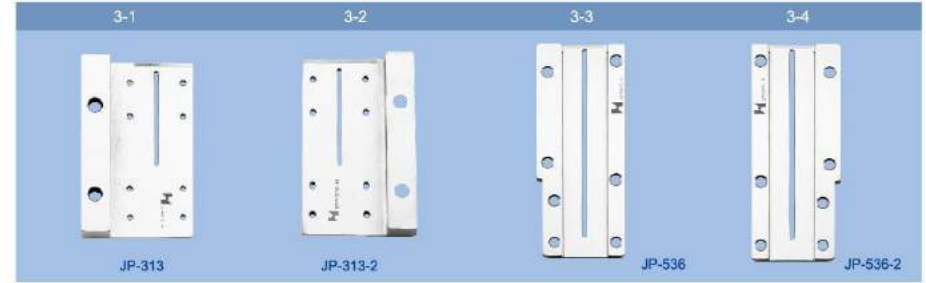
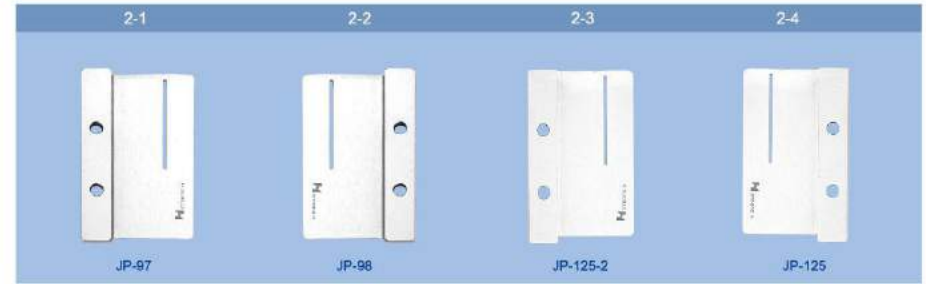
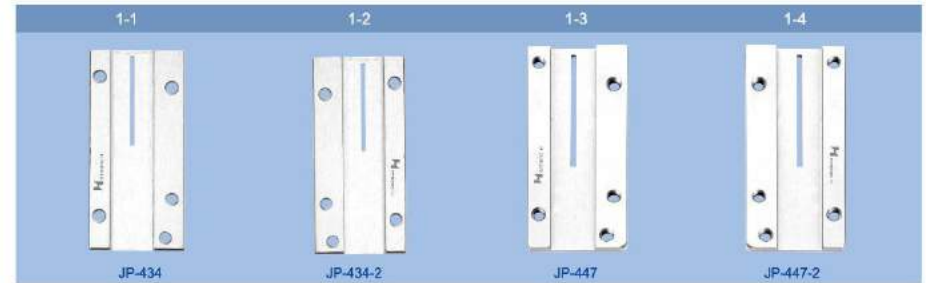



电脑绣花机附亮片绣刀类
KNIVES FOR COMPUTERIZED SEQUIN EMBROIDERY MACHINES
INDUSTRIAL SEWING MACHINE SPARE PARTS

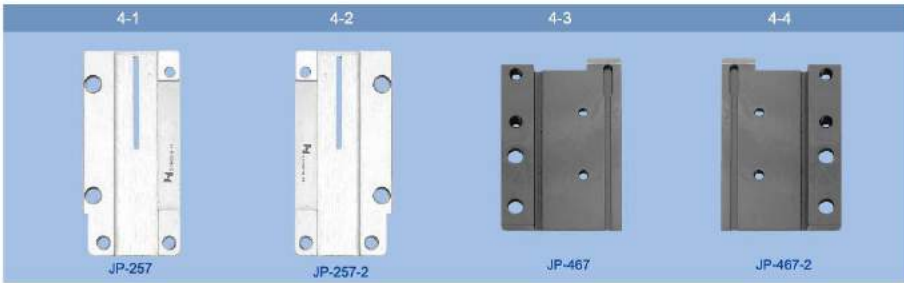
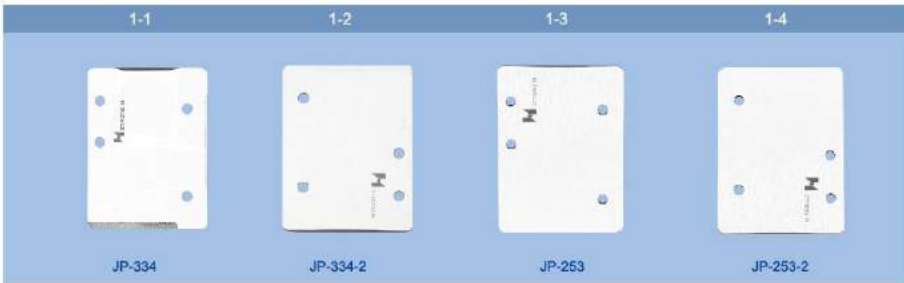

电脑绣花机附亮片绣刀类
KNIVES FOR COMPUTERIZED SEQUIN EMBROIDERY MACHINES
INDUSTRIAL SEWING MACHINE SPARE PARTS

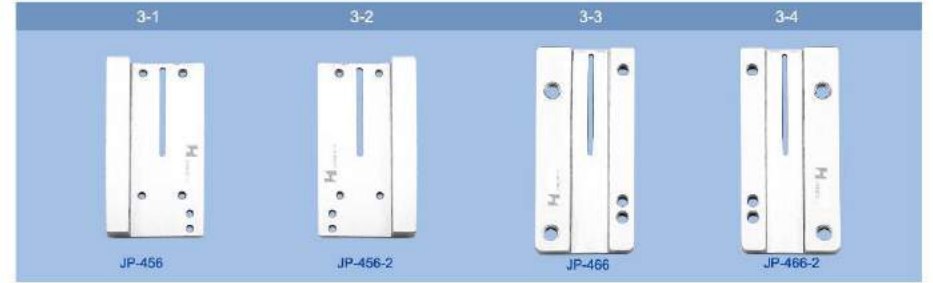



电脑绣花机附亮片绣刀类
KNIVES FOR COMPUTERIZED SEQUIN EMBROIDERY MACHINES
INDUSTRIAL SEWING MACHINE SPARE PARTS

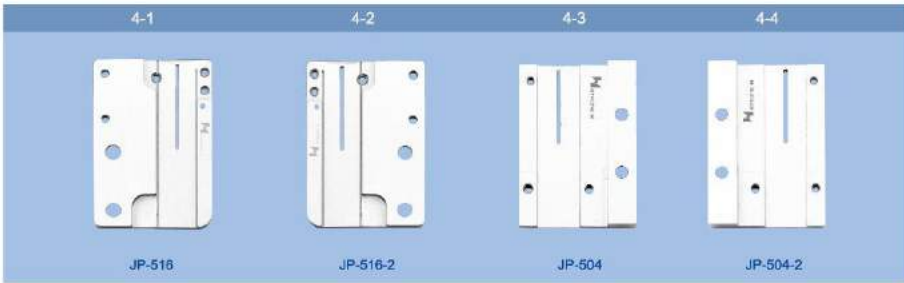
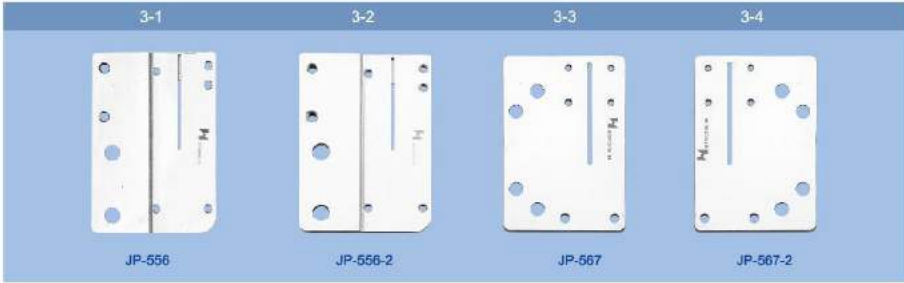
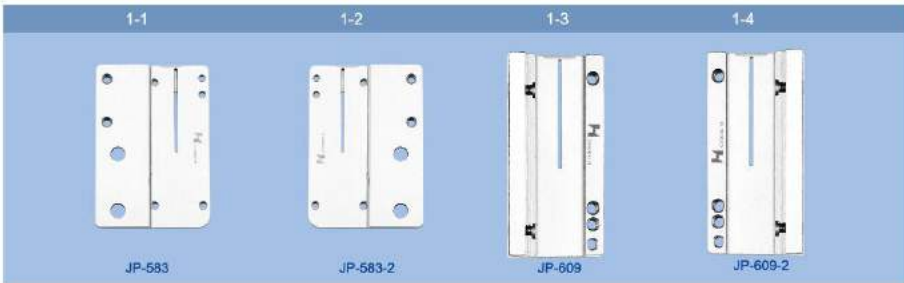

电脑绣花机附亮片绣刀类
KNIVES FOR COMPUTERIZED SEQUIN EMBROIDERY MACHINES
INDUSTRIAL SEWING MACHINE SPARE PARTS

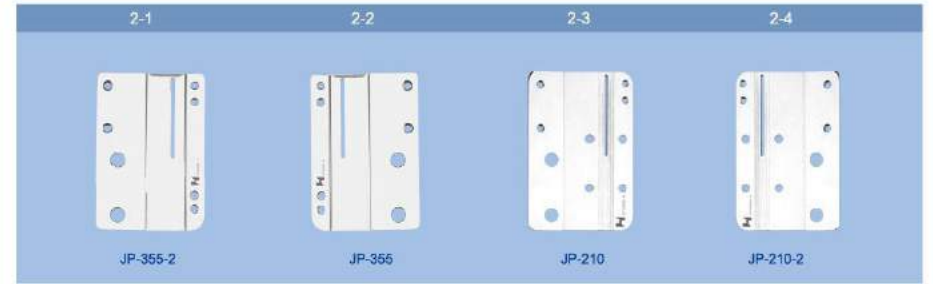
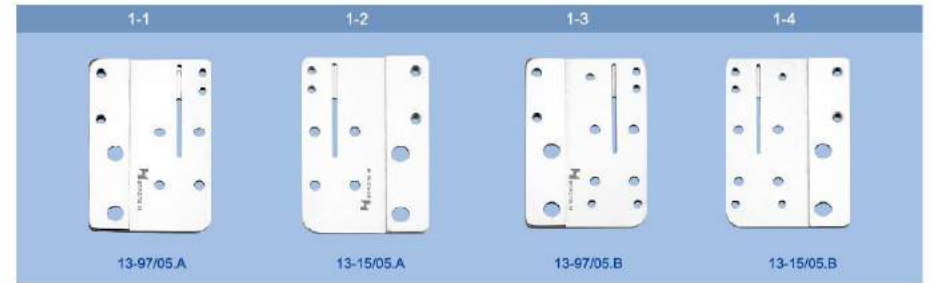

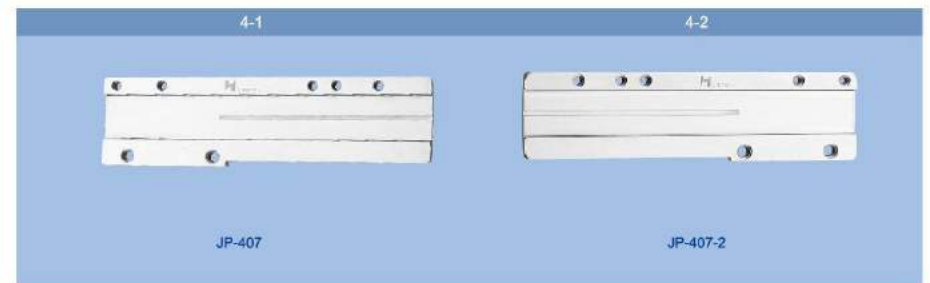
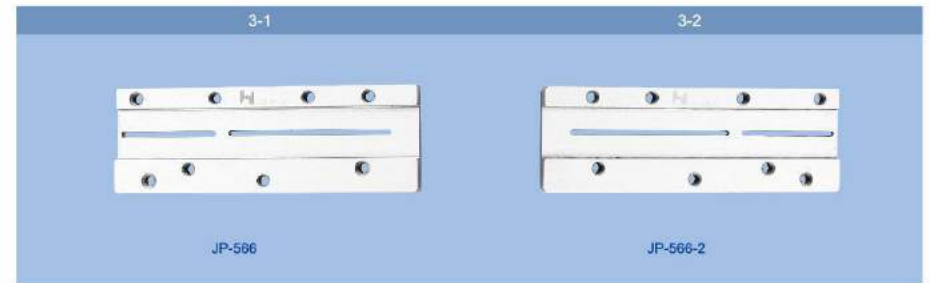
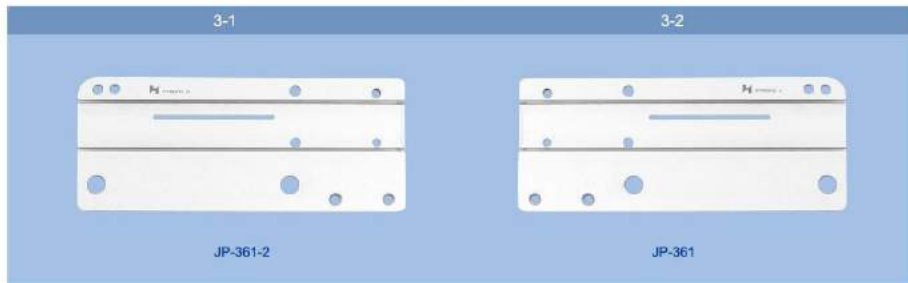
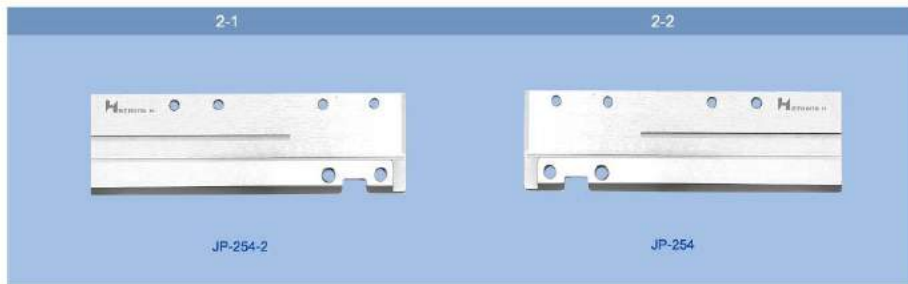
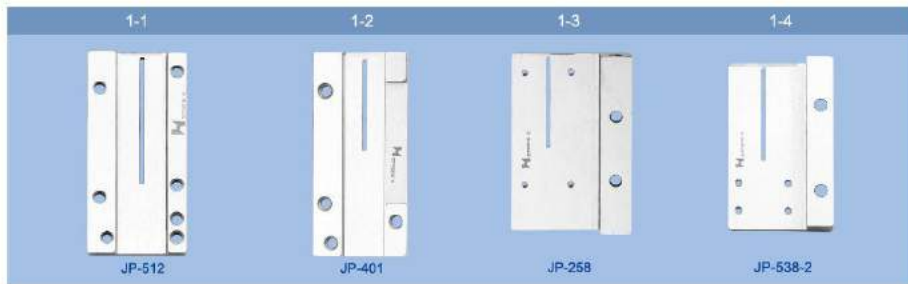

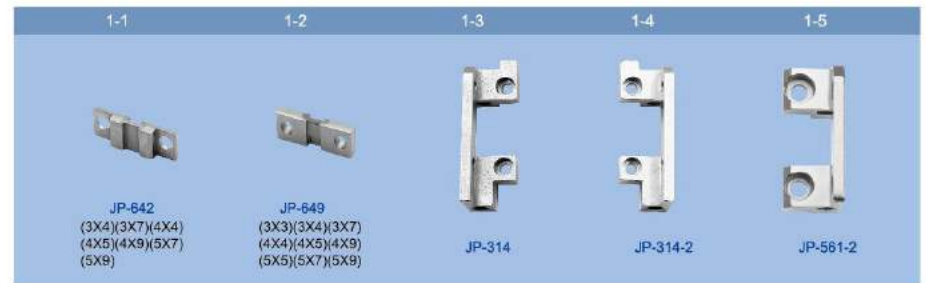
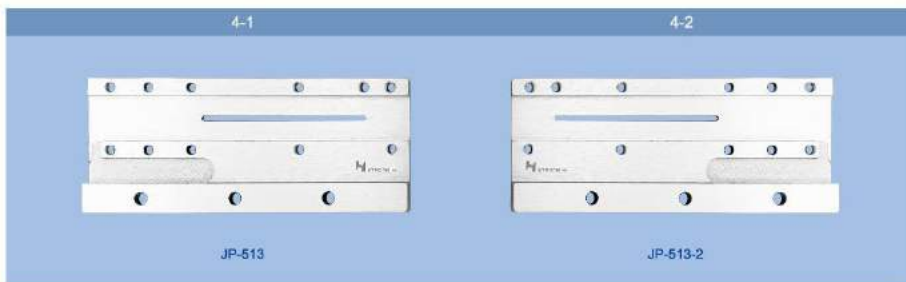



电脑绣花机附亮片绣刀类

KNIVES FOR COMPUTERIZED SEQUIN EMBROIDERY MACHINES

INDUSTRIAL SEWING MACHINE SPARE PARTS

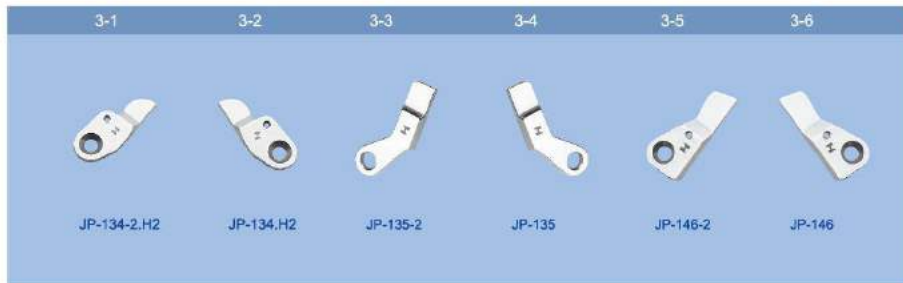
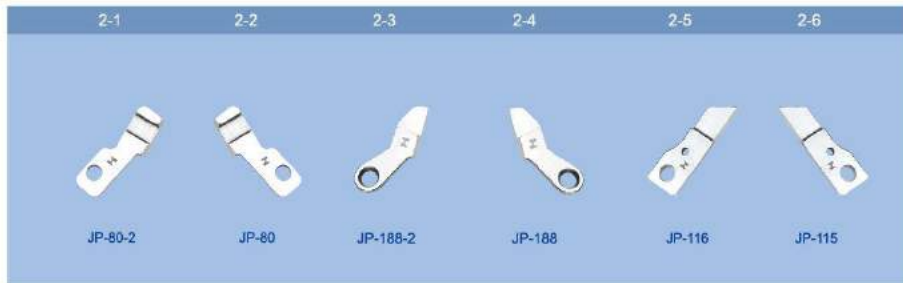
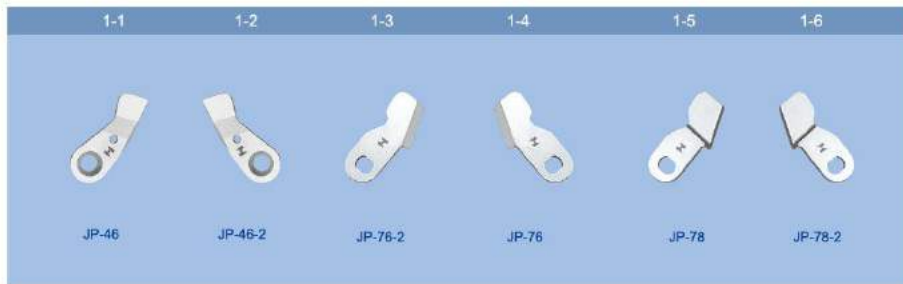

电脑绣花机附亮片绣刀类

KNIVES FOR COMPUTERIZED SEQUIN EMBROIDERY MACHINES

INDUSTRIAL SEWING MACHINE SPARE PARTS

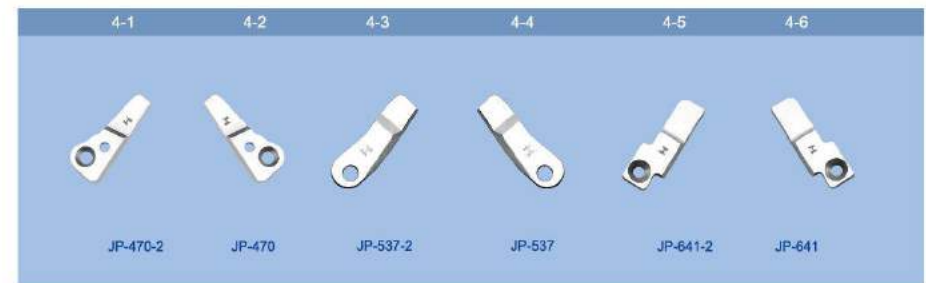
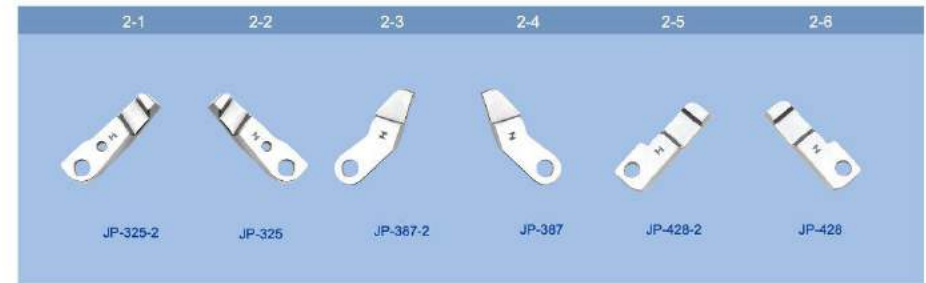
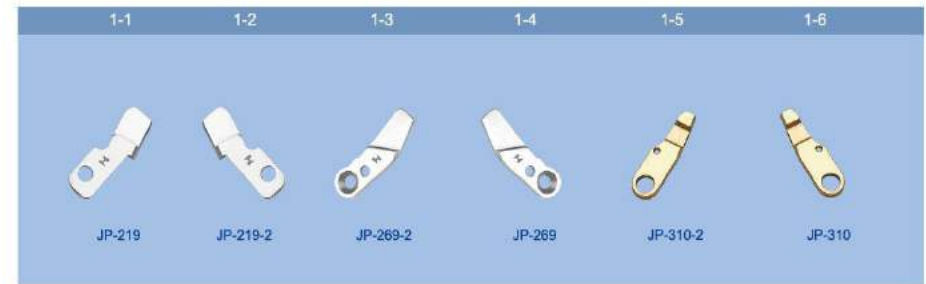



电脑绣花机附亮片绣刀类

KNIVES FOR COMPUTERIZED SEQUIN EMBROIDERY MACHINES

INDUSTRIAL SEWING MACHINE SPARE PARTS

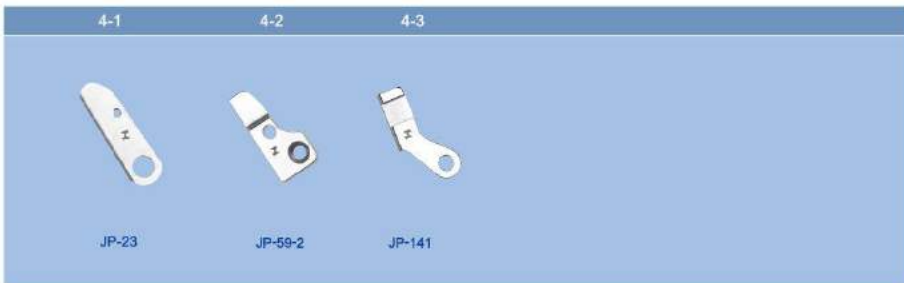
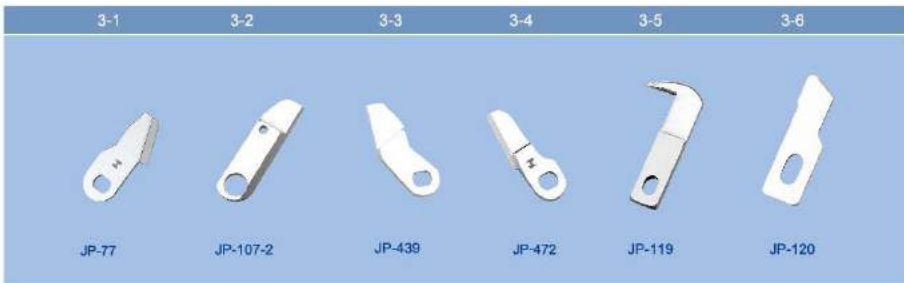
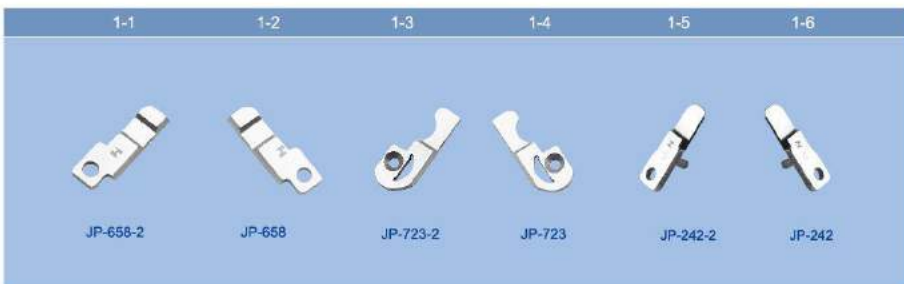

NEEDLE PLATE ASSEMBLY & SHUTTLE RACE ASSEMBLY

for industrial sewing machines
工业缝纫机针板剪线组件&梭床组



2015-2016 Catalogue



NEEDLE PLATE ASSEMBLY & SHUTTLE RACE ASSEMBLY for industrial sewing machines

工业缝纫机针板剪线组件 & 梭床组



2015-2016 Catalogue

工业缝纫机针板剪线组

NEEDLE PLATE ASSEMBLY FOR INDUSTRIAL SEWING MACHINES

INDUSTRIAL SEWING MACHINE SPARE PARTS



FOR BROTHER/兄弟

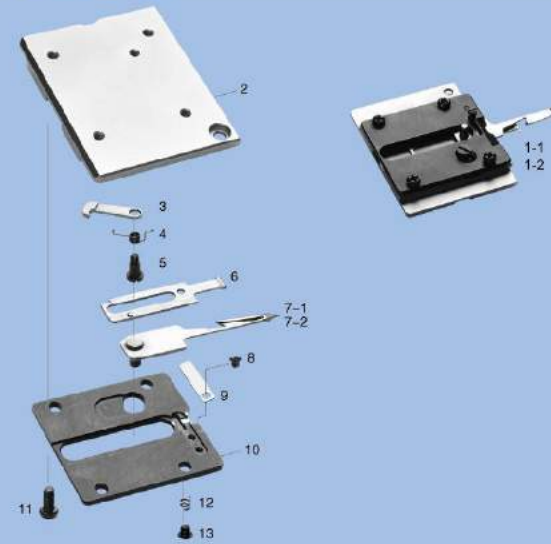

ZE-8560A 剪线组件

ASSEMBLY FOR ZE-8560A

No.	Part No.	Remarks
1-1	S48236-201	match7-1
1-2	S58941-201	match7-2
2	SA8458-001	
3	S55865-001	
4	S48246-001	
5	155103001	
6	SA8459-001	
7-1	S55863-001	
7-2	S58943-001	
8	100105005	
9	S48239-001	
10	S48238-101	
11	062670712	
12	S48240-001	
13	S48247001	

FOR BROTHER/兄弟

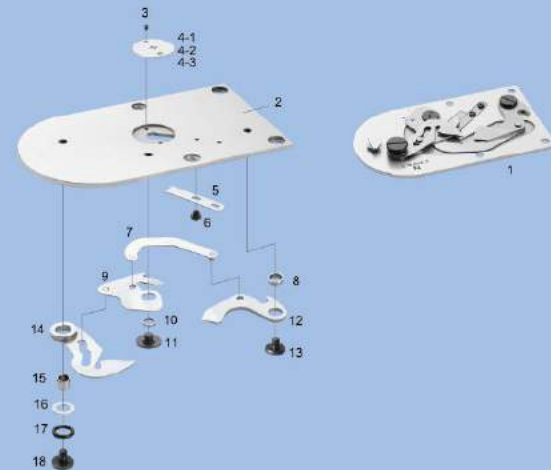

LK3-B430 剪线组件

ASSEMBLY FOR LK3-B430

No.	Part No.	Remarks
1	S18426-001	match 4.1&4.2&4.3
2	152995-001	
3	100360003	
4-1	156150-001	φ=1.8
4-2	156151-001	φ=2.2
4-3	156152-001	φ=2.5
5	152905-001	
6	111140002	
7	152897-201	
8	153220-001	
9	152901-001	
10	153219-001	
11	152904-001	
12	152981-001	
13	153222-001	
14	152906-101	
15	153597-001	
16	153596-001	
17	081008-070	
18	153598-001	

备注：可配φ1.8、φ2.2、φ2.5、φ2.6、φ2.8针孔小针板。
Remark: Can be matched needle plate sizeφ1.8, φ2.2,φ2.5,φ2.6,φ2.8.

FOR BROTHER/兄弟

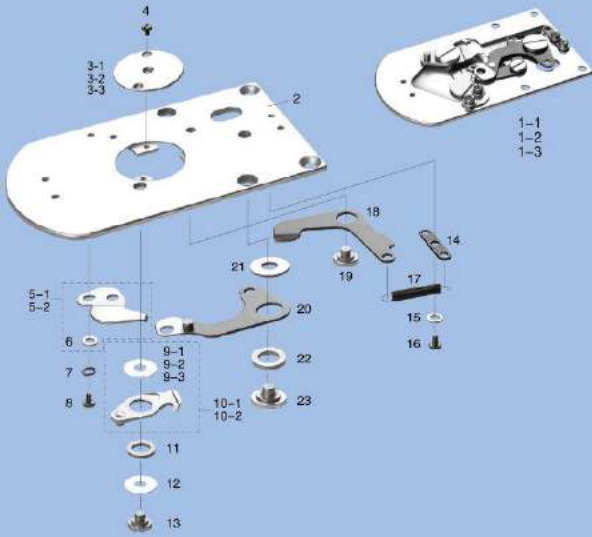

KE-430D 剪线组件
ASSEMBLY FOR KE-430D

No.	Part No.	Remarks
1-1	KE-430D(Light)	match 3-1, 3-2, 17, 18, 19, 20, 21, 22, 23
1-2	KE-430D(Medium)	match 3-2, 2, 17, 18, 19, 20, 21, 22, 23
1-3	KE-430D(Heavy)	match 3-3, 2, 17, 18, 19, 20, 21, 22, 23
2	SA3655-001	
3-1	SA3652-201	φ=1.6
3-2	SA3653-201	φ=2.2
3-3	SA3336-001	φ=2.4
4	100360003	
5-1	SA6597-001	
5-2	SA6431-001	
6	025030-236	
7	028030-246	
8	062300416	
9-1	SA6397-001	t=0.2
9-2	SA3334-001	t=0.3
9-3	SA6398-001	t=0.4
10-1	SA6596-001	
10-2	SA6429-001	
11	S00705-001	
12	SA4519-001	
13	SA4518-001	
14	SA3343-001	
15	025030-236	
16	062300416	
17	SA3344-001	
18	SA3341-001	
19	SA3342-001	
20	SA3337-001	
21	SA4330-001	
22	SA4329-001	
23	SA3333-001	

备注:可配φ1.6, φ1.8, φ2.0, φ2.2, φ2.4针孔小针板
Remark: Can be matched needle plate size φ1.6, φ1.8, φ2.0, φ2.2, φ2.4.

FOR BROTHER/兄弟

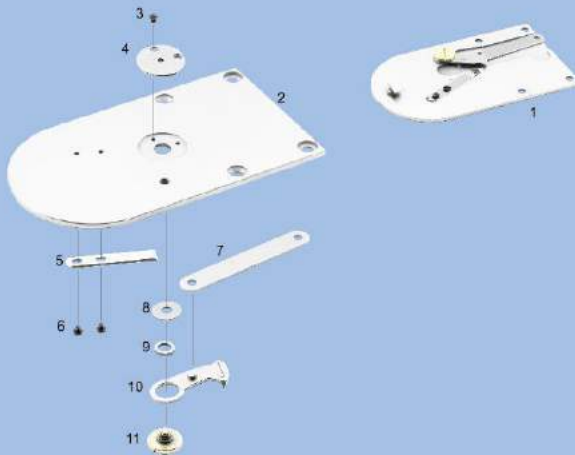

KE-430E 剪线组件
ASSEMBLY FOR KE-430E

No.	Part No.	Remarks
1	KE-430E	
2	S38015001	
3	100360003	
4	S10213101	
5	S10210201	
6	111140002	
7	S38016001	
8	S10208005	
9	S00705001	
10	S49988001	
11	S10209101	

FOR BROTHER/兄弟

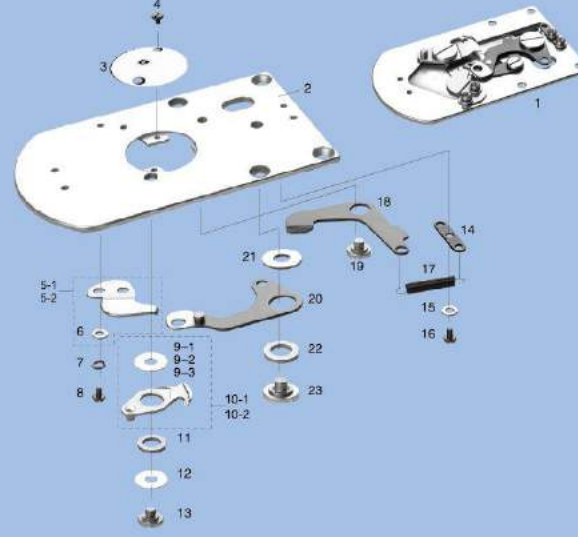

BE-438D 剪线组件
ASSEMBLY FOR BE-438D

No.	Part No.	Remarks
1	BE-438D(Light)	
2	SA3655-001	
3	SA3654-201	φ=1.6
4	100360003	
5-1	SA6431-001	
5-2	SA6597-001	
6	025030-236	
7	028030-246	
8	062300416	
9-1	SA6397-001	t=0.2
9-2	SA3334-001	t=0.3
9-3	SA6398-001	t=0.4
10-1	SA6596-001	
10-2	SA6429-001	
11	S00705-001	
12	SA4519-001	
13	SA4518-001	
14	SA3343-001	
15	025030-236	
16	062300416	
17	SA3344-001	
18	SA3341-001	
19	SA3342-001	
20	SA3337-001	
21	SA4330-001	
22	SA4329-001	
23	SA3333-001	

FOR BROTHER/兄弟

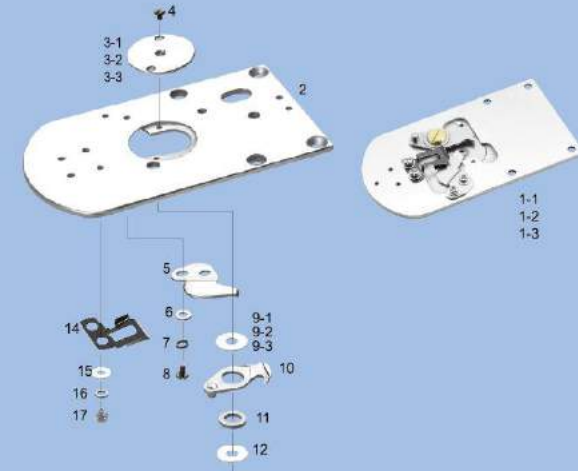

KE-430F 剪线组件
ASSEMBLY FOR KE-430F

No.	Part No.	Remarks
1-1	KE-430F(Light)	match 3-1, 3-2, 17, 18, 19, 20, 21, 22, 23
1-2	KE-430F(Medium)	match 3-2, 2, 17, 18, 19, 20, 21, 22, 23
1-3	KE-430F(Heavy)	match 3-3, 2, 17, 18, 19, 20, 21, 22, 23
2	SA3655-001	
3-1	SA3652-201	φ=1.6
3-2	SA3653-201	φ=2.2
3-3	SB0949-001	φ=2.4
4	100360003	
5	SB1191-001	
6	025030236	
7	028030246	
8	062300416	
9-1	SA6397-001	t=0.2
9-2	SA3334-001	t=0.3
9-3	SA6398-001	t=0.4
10	SB1189-001	
11	S00705-001	
12	SA4519-001	
13	SA4518-001	
14	SB0713-001	
15	025030236	
16	028030246	
17	062300416	

备注:可配φ1.6, φ2.2, φ2.4针孔小针板。
Remark: Can be matched needle plate size φ1.6, φ2.2, φ2.4.

FOR BROTHER/兄弟

**BE-438F 剪线组件
ASSEMBLY FOR BE-438F**

No.	Part No.	Remarks
1	BE-438F	
2	SA3655-001	
3	SA3654-201	φ=1.6
4	10036003	
5	SB1191-001	
6	025030236	
7	028030246	
8	062300416	
9-1	SA6397-001	t=0.2
9-2	SA3334-001	t=0.3
9-3	SA6398-001	t=0.4
10	SB1189-001	
11	S00705-001	
12	SA4519-001	
13	SA4518-001	
14	SB0713-001	
15	025030236	
16	028030246	
17	062300416	

FOR BROTHER/兄弟

**BAS-311G 剪线组件
ASSEMBLY FOR BAS-311G**

No.	Part No.	Remarks
1	SA5157-000	
2	SA5157-101	
3-1	SA5221-001	φ=2.2
3-2	SA3336-101	φ=2.4
4	100360003	
5	SA6273-101	
6	028030246	
7	025030236	
8	062300416	
9	SA7944-001	
10	025030236	
11	062300416	
12-1	SA6397-001	t=0.2
12-2	SA3334-001	t=0.3
12-3	SA6398-001	t=0.4
13	SA3330-001	
14	S00705-001	
15	SA4519-001	
16	SA4518-001	

备注:可配φ1.6, φ2.0, φ2.2, φ2.4针孔小针板
Remark:Can be matched needle plate sizeφ1.6, φ2.0, φ2.2, φ2.4.

FOR BROTHER/兄弟

**RH-9820 动刀剪线组
ASSEMBLY FOR RH-9820**

No.	Part No.	Remarks
1	RH-9820-1	
2	S34899-001	
3	SA7076-001	
4	S01694001	
5	104336003	
6	141546001	
7	152904-001	
8	153219-001	
9	S34900-001	
10	060630312	
11	S34884-000	
12	S34901-001	

FOR BROTHER/兄弟

**RH-9820 定刀剪线组
ASSEMBLY FOR RH-9820**

No.	Part No.	Remarks
1	RH-9820-2	
2	018260-832	
3	S34894-004	
4	S34886-001	
5	S34887-001	
6	S34895-001	
7	026300-512	
8	S34894-001	
9	S34896-001	
10	062020-416	
11	061300-416	
12	542515-001T	
13	021020-106	
14	S34890-001	
15	S34888-101	
16	S34892-001	
17	S34891-101	



工业缝纫机针板剪线组

NEEDLE PLATE ASSEMBLY FOR INDUSTRIAL SEWING MACHINES

INDUSTRIAL SEWING MACHINE SPARE PARTS

FOR BROTHER/兄弟

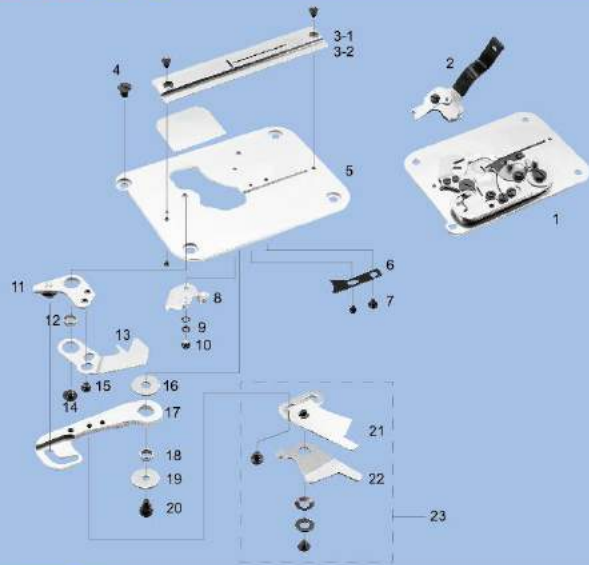

HE-800A剪线组件 ASSEMBLY FOR HE800A

No.	Part No.	Remarks
1	S10696-001	
2	S50404-401	
3-1	S51248-101(1,2)	
3-2	S50664-001(1,4)	
4	106629002	
5	S50393-101	
6	S50270-000	
7	110215002	
8	S50265-001	
9	025040132	
10	141514001	
11	S50253-001	
12	S50257-001	
13	S50258-201	
14	S00712101	
15	110215002	
16	SA3001-001	
17	S50252-001	
18	S00903-001	
19	S00901-001	
20	159272001	
21	S50260-101	
22	S50263-001	
23	S50259-101	

FOR JUKI/重机

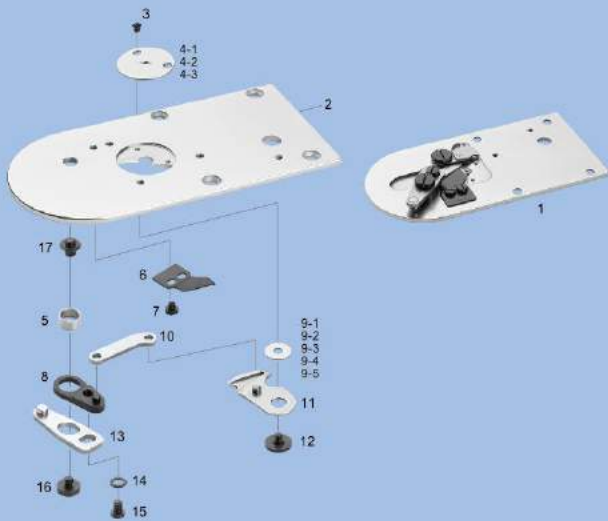

LK-1850 剪线组件 ASSEMBLY FOR LK-1850

No.	Part No.	Remarks
1	LK-1850	match 4-1/4-2/4-3
2	135-15564	
3	SS-1060210-TP	
4-1	B2426-280-000	φ=1.6
4-2	B2426-280-00B	φ=2.0
4-3	B2426-280-00C	φ=2.3
5	B2416-280-000	
6	B2424-280-000	
7	SS-7090410-SP	
8	B2415-280-0A0	
9-1	B2423-280-00A	t=0.4
9-2	B2423-280-00B	t=0.5
9-3	B2423-280-00C	t=0.6
9-4	B2423-280-00D	t=0.7
9-5	B2423-280-00E	t=0.8
10	B2418-280-000	
11	B2421-280-0A0	
12	SD-0500091-TP	
13	B2414-280-0A0	
14	WP-0450846-SP	
15	SS-7110740-TP	
16	SS-6110430-TP	
17	B2417-280-000	

备注：可配φ1.6, φ1.8, φ2.0, φ2.3, φ2.4, φ2.6, φ2.8, φ3.0冲针/小针板。
Remark: Can be matched needle plate size φ1.6, φ1.8, φ2.0, φ2.3, φ2.4, φ2.6, φ2.8, φ3.0.

工业缝纫机针板剪线组

NEEDLE PLATE ASSEMBLY FOR INDUSTRIAL SEWING MACHINES

INDUSTRIAL SEWING MACHINE SPARE PARTS



FOR JUKI/重机

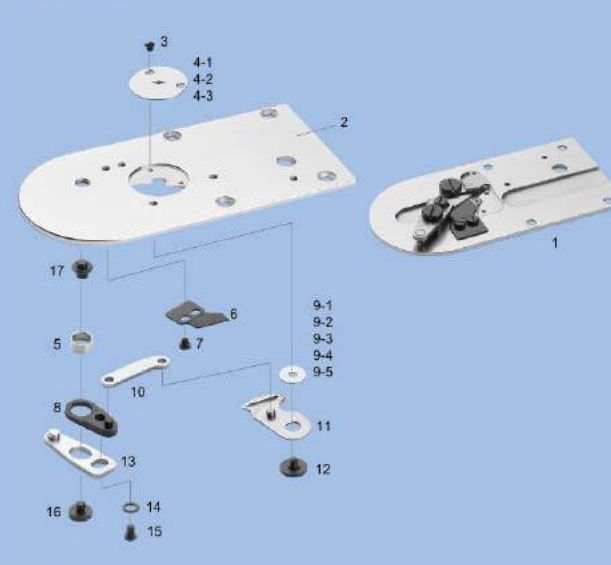

LK-1900 剪线组件 ASSEMBLY FOR LK-1900

No.	Part No.	Remarks
1	LK-1900	match 4-1/4-2/4-3
2	135-15507	
3	SS-1060210-TP	
4-1	B2426-280-000	φ=1.6
4-2	B2426-280-00B	φ=2.0
4-3	B2426-280-00C	φ=2.3
5	B2416-280-000	
6	B2424-280-000	
7	SS-7090410-SP	
8	B2415-280-0A0	
9-1	B2423-280-00A	t=0.4
9-2	B2423-280-00B	t=0.5
9-3	B2423-280-00C	t=0.6
9-4	B2423-280-00D	t=0.7
9-5	B2423-280-00E	t=0.8
10	B2418-280-000	
11	B2421-280-0A0	
12	SD-0500091-TP	
13	B2414-280-0A0	
14	WP-0450846-SP	
15	SS-7110740-TP	
16	SS-6110430-TP	
17	B2417-280-000	

备注：可配φ1.6, φ1.8, φ2.0, φ2.3, φ2.4, φ2.6, φ2.8, φ3.0冲针/小针板。
Remark: Can be matched needle plate size φ1.6, φ1.8, φ2.0, φ2.3, φ2.4, φ2.6, φ2.8, φ3.0.

FOR JUKI/重机

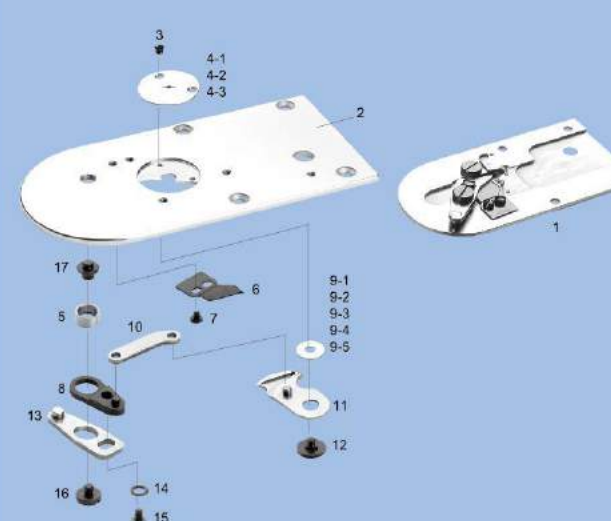

LK-1900A 剪线组件 ASSEMBLY FOR LK-1900A

No.	Part No.	Remarks
1	LK-1900A	match 4-1/4-2/4-3
2	400-06721	
3	SS-1060210-TP	
4-1	B2426-282-C00	φ=1.6
4-2	B2426-280-00B	φ=2.0
4-3	B2426-280-00C	φ=2.3
5	B2416-280-000	
6	B2424-280-000	
7	SS-7090410-SP	
8	B2415-280-0A0	
9-1	B2423-280-00A	t=0.4
9-2	B2423-280-00B	t=0.5
9-3	B2423-280-00C	t=0.6
9-4	B2423-280-00D	t=0.7
9-5	B2423-280-00E	t=0.8
10	B2418-280-000	
11	B2421-280-0A0	
12	SD-0500091-TP	
13	B2414-280-0A0	
14	WP-0450846-SP	
15	SS-7110740-TP	
16	SS-6110430-TP	
17	B2417-280-000	

备注：可配φ1.6, φ2.0, φ2.3, φ2.4, φ2.6, φ2.8冲针/小针板。
Remark: Can be matched needle plate size φ1.6, φ2.0, φ2.3, φ2.4, φ2.6, φ2.8.

FOR JUKI/重机

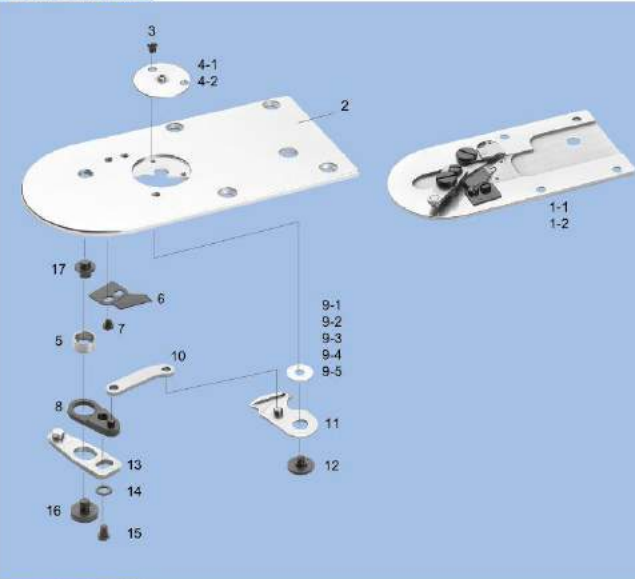

LK-1903A 剪线组件
ASSEMBLY FOR LK-1903A

No.	Part No.	Remarks
1-1	400-06725	
1-2	400-06726	
2	400-06721	
3	SS-1060210-TP	
4-1	MAZ-15801000	φ=1.6
4-2	MAZ-15601000	φ=2.0
5	B2416-280-000	
6	B2424-280-000	
7	SS-7090410-SP	
8	B2415-280-0A0	
9-1	B2423-280-00A	t=0.4
9-2	B2423-280-00B	t=0.5
9-3	B2423-280-00C	t=0.6
9-4	B2423-280-00D	t=0.7
9-5	B2423-280-00E	t=0.8
10	B2418-280-000	
11	B2421-280-0A0	
12	SD-0500091-TP	
13	B2414-280-0A0	
14	WP-0450846-SP	
15	SS-7110740-TP	
16	SS-6110430-TP	
17	B2417-280-000	

备注: 可配φ1.6、φ2.0针孔小针板。
Remark: Can be matched needle plate size φ1.6, φ2.0.

FOR JUKI/重机

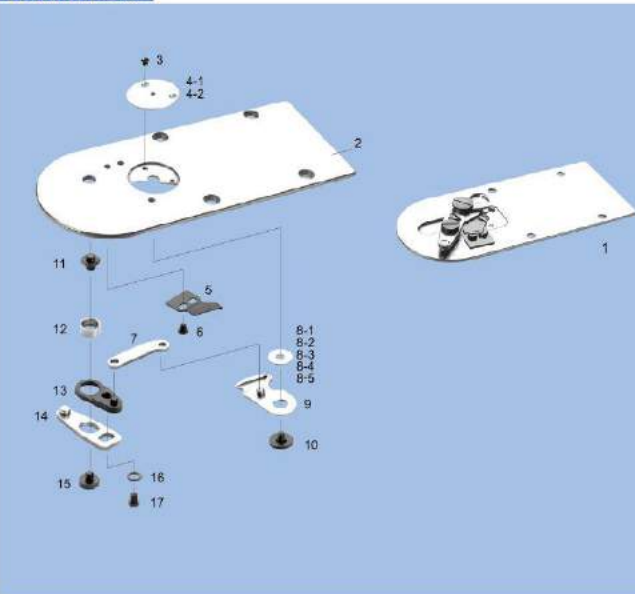

LK-1910/1920 剪线组件
ASSEMBLY FOR LK-1910/1920

No.	Part No.	Remarks
1	LK1910/LK1920	match 6.142
2	142-13003	
3	SS-1060210-TP	
4-1	D2426-284-M00	φ=1.6
4-2	141-09607	φ=2.3
5	B2424-280-000	
6	SS-7090410-SP	
7	B2418-280-000	
8-1	B2423-280-00A	t=0.4
8-2	B2423-280-00B	t=0.5
8-3	B2423-280-00C	t=0.6
8-4	B2423-280-00D	t=0.7
8-5	B2423-280-00E	t=0.8
9	B2421-280-0A0	
10	SD-0500091-TP	
11	B2417-280-000	
12	B2416-280-000	
13	B2416-210-DA0	
14	B2414-280-000	
15	SS-6110430-TP	
16	WP-0450846-SP	
17	SS-7110740-TP	

备注: 可配φ1.6、φ1.8、φ2.0、φ2.3、φ2.4针孔小针板。
Remark: Can be matched needle plate size φ1.6, φ1.8, φ2.0, φ2.3, φ2.4.

FOR JUKI/重机

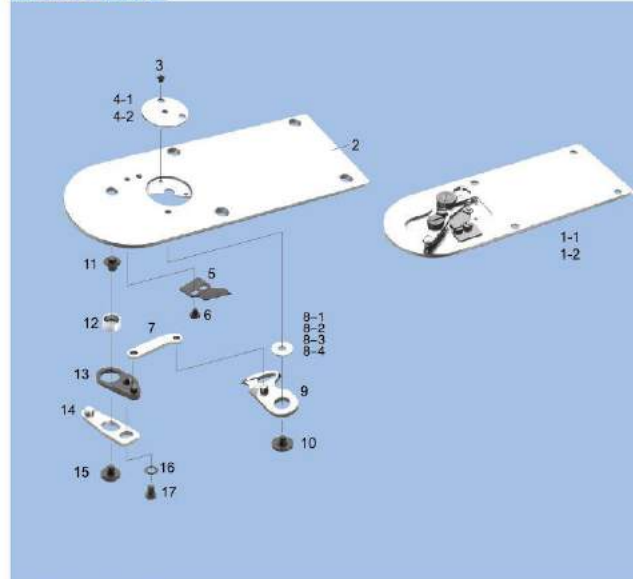

AMS-210D 剪线组件
ASSEMBLY FOR AMS-210D

No.	Part No.	Remarks
1-1	B2425-210-DAA	
1-2	B2425-210-DAB	
2	B2425-210-000	
3	SS-1060210-TP	
4-1	B2426-210-00A	φ=1.6
4-2	B2426-210-00B	φ=2.0
5	B2424-210-000	
6	SS-7090410-SP	
7	B2418-280-000	
8-1	B2423-280-00A	t=0.4
8-2	B2423-280-00B	t=0.5
8-3	B2423-280-00C	t=0.6
8-4	B2423-280-00D	t=0.7
9	B2421-210-AA0	
10	B2417-210-000	
11	B2417-280-000	
12	B2416-280-000	
13	B2416-210-0A0	
14	B2414-280-0A0	
15	SS-6110430-TP	
16	WP-0450846-SP	
17	SS-7110740-TP	

备注: 可配φ1.6、φ2.0、φ2.4、φ2.8、φ3.0针孔小针板。
Remark: Can be matched needle plate size φ1.6, φ2.0, φ2.4, φ2.8, φ3.0.

FOR JUKI/重机

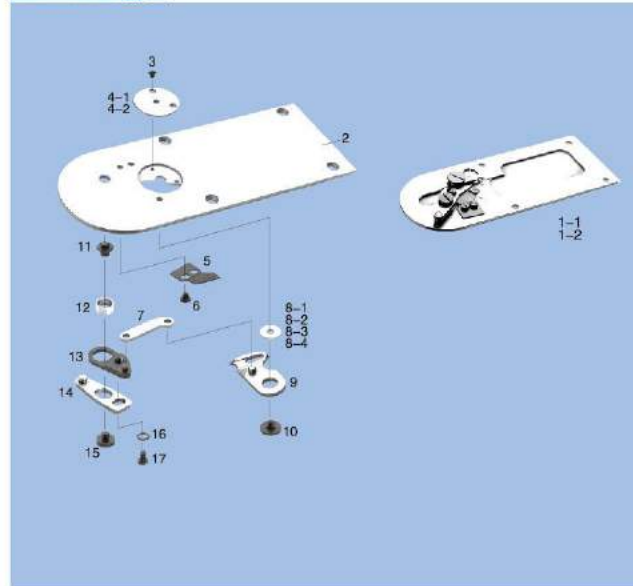

AMS-210E 剪线组件
ASSEMBLY FOR AMS-210E

No.	Part No.	Remarks
1-1	40030932	
1-2	40030933	
2	40030934	
3	SS-1060210-TP	
4-1	B2426-210-00A	φ=1.6
4-2	B2426-210-00B	φ=2.0
5	B2424-210-000	
6	SS-7090410-SP	
7	B2418-280-000	
8-1	B2423-280-00A	t=0.4
8-2	B2423-280-00B	t=0.5
8-3	B2423-280-00C	t=0.6
8-4	B2423-280-00D	t=0.7
9	B2421-210-AA0	
10	B2417-210-000	
11	B2417-280-000	
12	B2416-280-000	
13	B2416-210-0A0	
14	B2414-280-0A0	
15	SS-6110430-TP	
16	WP-0450846-SP	
17	SS-7110740-TP	

备注: 可配φ1.6、φ2.0、φ3.0针孔小针板。
Remark: Can be matched needle plate size φ1.6, φ2.0, φ3.0.

FOR JUKI/重机

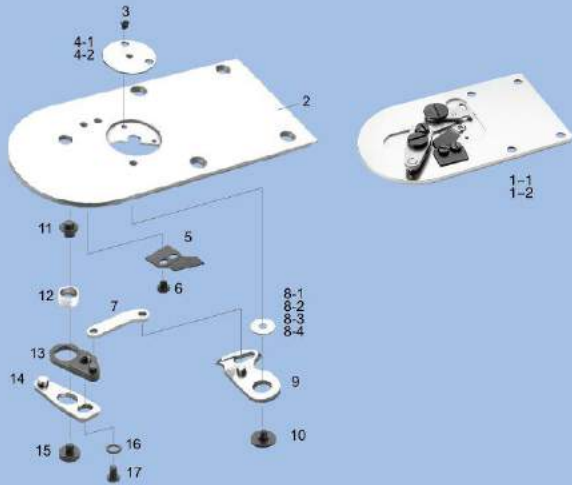

AMS-215D 剪线组件
ASSEMBLY FOR AMS-215D

No.	Part No.	Remarks
1-1	B2425-221-DAA	match4-1
1-2	B2425-221-DAB	match4-2
2	B2425-215-P00	
3	SS-1060210-TP	
4-1	B2426-210-00A	$\phi=1.6$
4-2	B2426-210-00B	$\phi=2.0$
5	B2424-210-000	
6	SS-7090410-SP	
7	B2418-280-000	
8-1	B2423-280-00A	t=0.4
8-2	B2423-280-00B	t=0.5
8-3	B2423-280-00C	t=0.6
8-4	B2423-280-00D	t=0.7
9	B2421-210-AA0	
10	B2417-210-000	
11	B2417-280-000	
12	B2416-280-000	
13	B2416-210-0A0	
14	B2414-280-0A0	
15	SS-6110430-TP	
16	WP-0450846-SP	
17	SS-7110740-TP	

备注:可配 $\phi 1.6$, $\phi 2.0$, $\phi 2.8$, $\phi 3.0$ 针小针板。
Remark: Can be matched needle plate size $\phi 1.6$, $\phi 2.0$, $\phi 2.8$, $\phi 3.0$.

FOR JUKI/重机



MB-373 剪线组件
ASSEMBLY FOR MB-373

No.	Part No.	Remarks
1	B1241-373-0B0	
2	B1241-373-000	
3	B2406-373-0A0	
4	SD-0600095-TH	
5	B2410-373-000	
6	SS-7080310-SP	

FOR JUKI/重机

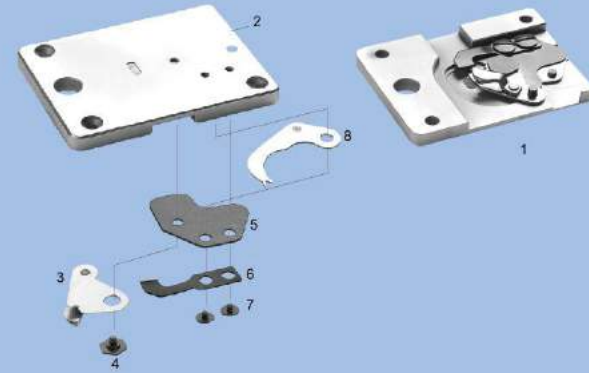

MB-377 剪线组件
ASSEMBLY FOR MB-377

No.	Part No.	Remarks
1	B1241-377-0B0	
2	B1241-377-000	
3	B2406-373-0A0	
4	SD-0600095-TH	
5	B2702-377-000	
6	B2410-373-000	
7	SS-7080310-SP	
8	B2703-377-0A0	

FOR JUKI/重机

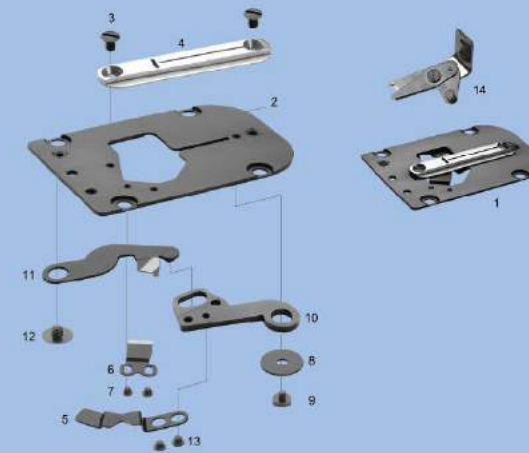

LBH-780 剪线组件
ASSEMBLY FOR LBH-780

No.	Part No.	Remarks
1	B2401-771-0A0	
2	B2401-771-0B0	
3	SS-2090510-SP	
4	B2402-771-000	
5	B2405-771-000	
6	B2408-771-000-A	
7	SS-4080310-SP	
8	WP-0451016-SP	
9	SS-7110570-SP	
10	B2404-771-000	
11	B2406-771-0A0	
12	SS-5090320-SP	
13	SS-6090440-SP	
14	B2001-771-0A0	



工业缝纫机针板剪线组

NEEDLE PLATE ASSEMBLY FOR INDUSTRIAL SEWING MACHINES

INDUSTRIAL SEWING MACHINE SPARE PARTS

FOR JUKI/重机

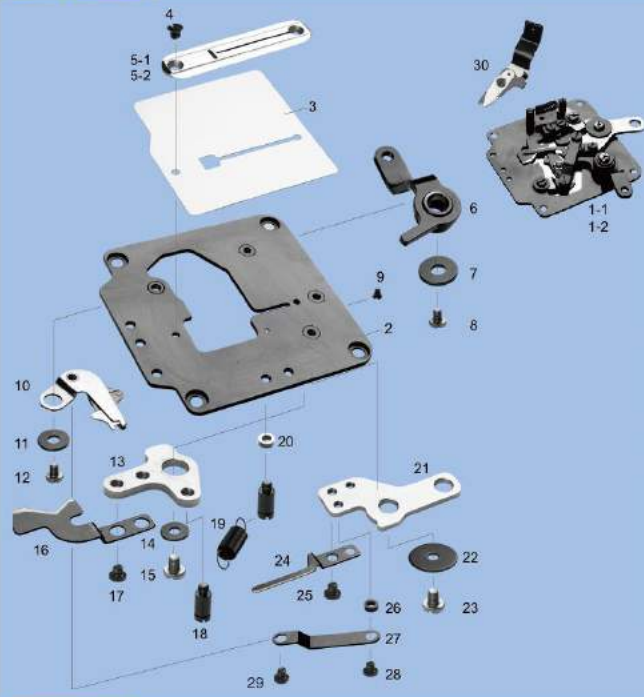

LBH-1790 剪线组 ASSEMBLY FOR LBH-1790

No.	Part No.	Remarks
1-1	400-04300	match5-1
1-2	400-04370	match5-2
2	400-04301	
3	400-04324	
4	SM-1030400-SP	
5-1	400-27553	1.4×6.2
5-2	400-27554	1.2×6.2
6	400-04321	
7	WP-0431005-SP	
8	SM-6040450-TP	
9	SD-0250101-SP	
10	400-04311	
11	WP-0431005-SP	
12	SM-6040450-TP	
13	400-04309	
14	WP-0431005-SP	
15	SM-5040655-SP	
16	400-22323	
17	SM-6040450-TP	
18	400-04327	
19	400-29613	
20	B1623-180-000	
21	400-04306	
22	WP-0451016-SP	
23	SM-5040655-SP	
24	400-22322	
25	SM-6040450-TP	
26	B3013-141-H0A	
27	400-04308	
28	SD-0500167-TP	
29	SD-0500166-TP	
30	400-04255	

FOR JUKI/重机

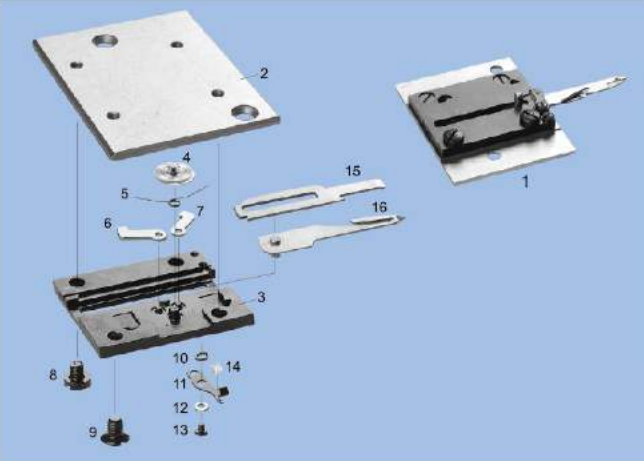

LZ-2290 剪线组件 ASSEMBLY FOR LZ-2290

No.	Part No.	Remarks
1	225-57458	
2	225-58308	
3	225-58407	
4	NP-2103000-00	
5	225-58209	
6	225-57904	
7	225-57805	
8	SS-7090610-SP	
9	SS-1090510-SP	
10	D2056-772-B0B	
11	225-58100	
12	WS-027002-KN	
13	SS-7080310-SP	
14	225-58001	
15	225-57706	
16	225-57557	

工业缝纫机针板剪线组

NEEDLE PLATE ASSEMBLY FOR INDUSTRIAL SEWING MACHINES

INDUSTRIAL SEWING MACHINE SPARE PARTS



FOR JUKI/重机

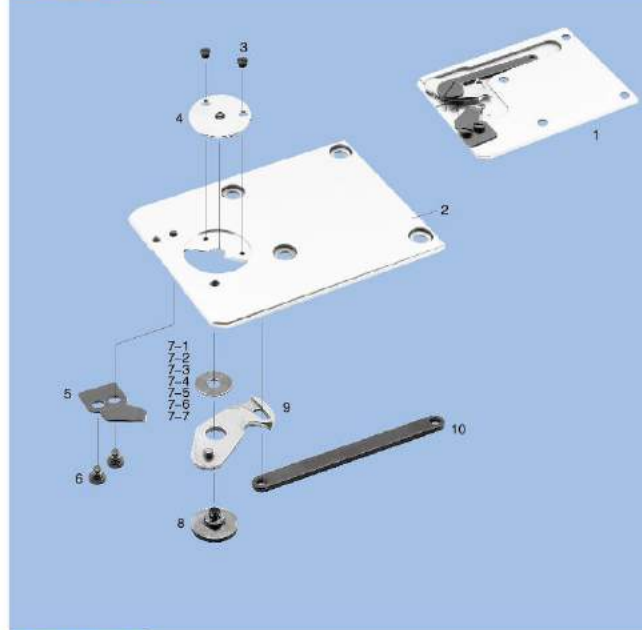

MOL-254前剪线组件 ASSEMBLY FOR MOL-254

No.	Part No.	Remarks
1		
2	B2417-210-000	
3	SS-1060210-TP	
4	138-82501	
5	B2424-210-000	
6	SS-7090410-SP	
7-1	B2423-280-00A	t=0.4
7-2	B2423-280-00B	t=0.5
7-3	B2423-280-00C	t=0.6
7-4	B2423-280-00D	t=0.7
7-5	B2423-280-00E	t=0.8
7-6	B2423-280-00F	t=0.65
7-7	B2423-280-00G	t=0.75
8	B2417-210-000	
9	138-81255	
10	138-82105	

FOR JUKI/重机

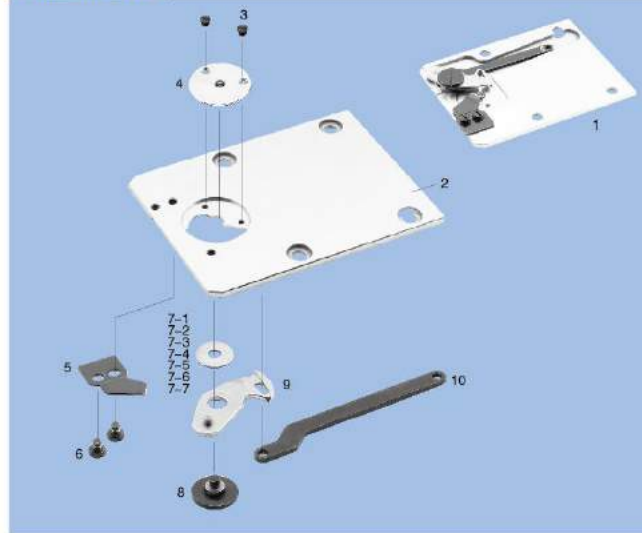

MOL-254后剪线组件 ASSEMBLY FOR MOL-254

No.	Part No.	Remarks
1		
2	138-86304	
3	SS-1060210-TP	
4	138-82501	
5	B2424-210-000	
6	SS-7090410-SP	
7-1	B2423-280-00A	t=0.4
7-2	B2423-280-00B	t=0.5
7-3	B2423-280-00C	t=0.6
7-4	B2423-280-00D	t=0.7
7-5	B2423-280-00E	t=0.8
7-6	B2423-280-00F	t=0.65
7-7	B2423-280-00G	t=0.75
8	B2417-210-000	
9	138-81255	
10	138-87302	

FOR MITSUBISI/三菱

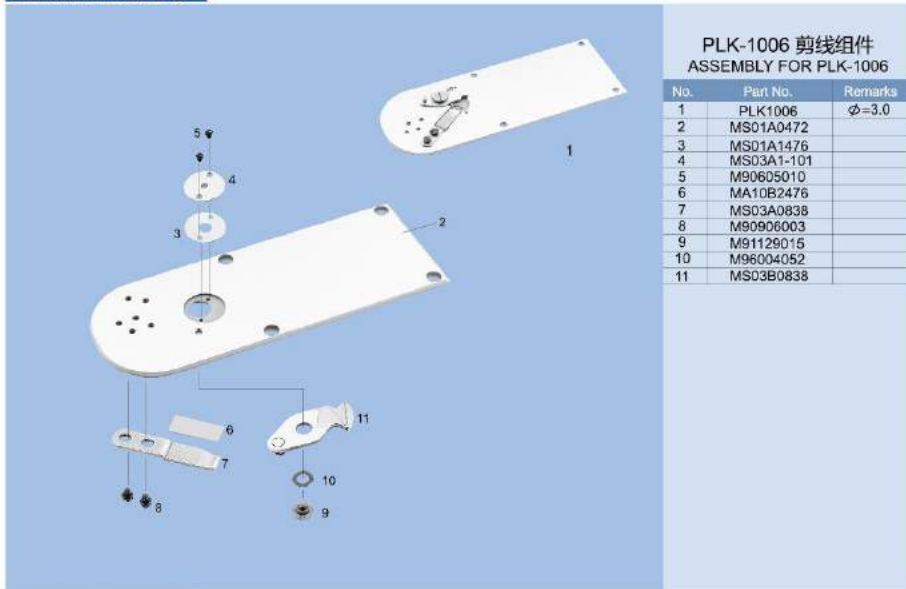

PLK-1006 剪线组件
ASSEMBLY FOR PLK-1006

No.	Part No.	Remarks
1	PLK1006	Φ=3.0
2	MS01A0472	
3	MS01A1476	
4	MS03A1-101	
5	M90605010	
6	MA10B2476	
7	MS03A0838	
8	M90906003	
9	M91129015	
10	M96004052	
11	MS03B0838	

FOR SUN STAR/日星

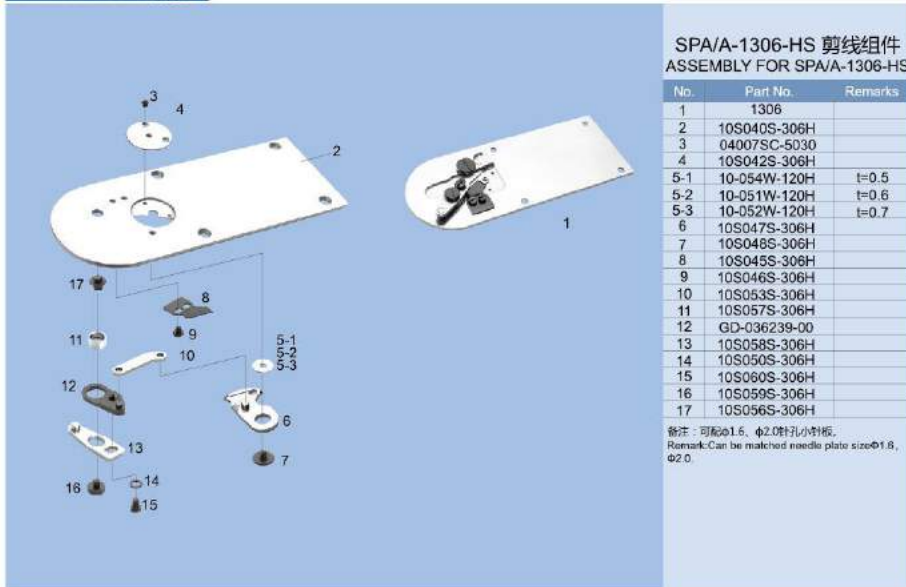

SPA/A-1306-HS 剪线组件
ASSEMBLY FOR SPA/A-1306-HS

No.	Part No.	Remarks
1	1306	
2	10S040S-306H	
3	04007SC-5030	
4	10S042S-306H	
5-1	10-054W-120H	t=0.5
5-2	10-051W-120H	t=0.6
5-3	10-052W-120H	t=0.7
6	10S047S-306H	
7	10S048S-306H	
8	10S045S-306H	
9	10S046S-306H	
10	10S053S-306H	
11	10S057S-306H	
12	GD-036239-00	
13	10S058S-306H	
14	10S050S-306H	
15	10S060S-306H	
16	10S059S-306H	
17	10S056S-306H	

备注：可配Φ1.5、Φ2.0针孔小针板。
Remark: Can be matched needle plate size Φ1.8, Φ2.0.

FOR YAMATO/大和

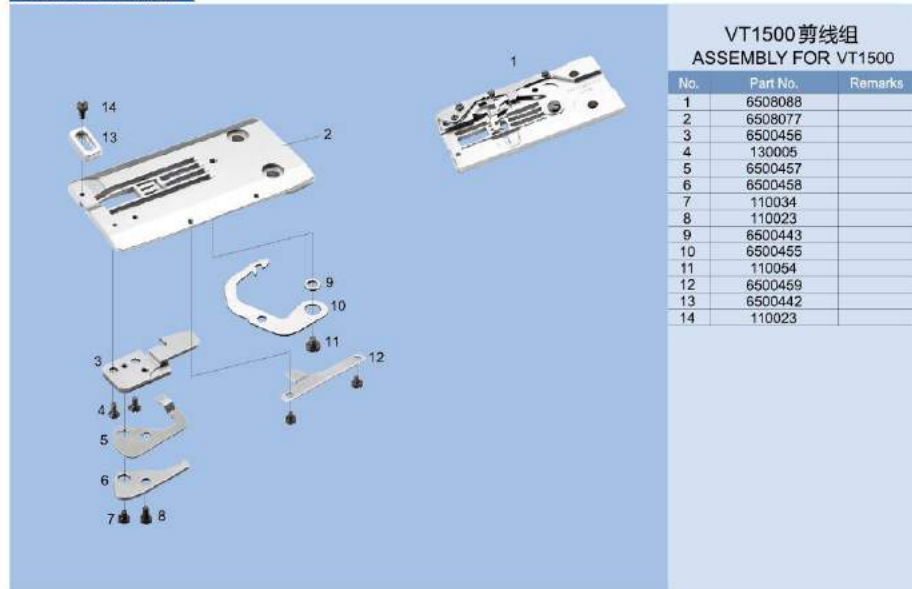

VT1500 剪线组
ASSEMBLY FOR VT1500

No.	Part No.	Remarks
1	6508088	
2	6508077	
3	6500456	
4	130005	
5	6500457	
6	6500458	
7	110034	
8	110023	
9	6500443	
10	6500455	
11	110054	
12	6500459	
13	6500442	
14	110023	



工业缝纫机梭床组件
SHUTTLE RACE ASSEMBLY FOR INDUSTRIAL SEWING MACHINES
INDUSTRIAL SPLITTING MACHINE SPARE PARTS

FOR BROTHER/兄弟



机型 Model	梭床组 Shuttle Race Assembly	梭托 Shuttle Driver	梭床盖 Shuttle Race Cover	
			中厚料 Medium	厚料 Heavy
KE-430D	SA3239-301	SA3284-201		
KE-430F	SB1173-001	SA6448-301		
BAS-311G	SA7575-101	SA3284-201	152682-201	152686-201
BAS-326G		S55215-001		
BAS-311F	S55217-201	S55215-001		
BAS-342G	SA8704-101	SA6448-301		

FOR JUKI/重机



机型 Model	梭床组 Shuttle Race Assembly	梭托 Shuttle Driver	梭床盖 Shuttle Race Cover		
			薄料 Thin	中厚料 Medium	厚料 Heavy
LK-1900	141-03055	B1812-980-0A0			
LK-1900A	400-06573	400-11512	141-03253	141-03352	141-03659
AMS-210D	B1814-210-DA0	B1812-210-D00	—	B1817-210-DAB	—
AMS-210E	400-32671	400-14963	—	141-03352	—

工业缝纫机梭床组件
SHUTTLE RACE ASSEMBLY FOR INDUSTRIAL SEWING MACHINES
INDUSTRIAL SPLITTING MACHINE SPARE PARTS



FOR MITSUBISHI/三菱



机型 Model	梭床组 Shuttle Race Assembly	梭托 Shuttle Driver	梭床盖 Shuttle Race Cover
PLK-E1010	MS01A0121	MS01A0611	MS08A0616



GAUGE SET

for industrial sewing machines
工业缝纫机针位组



2015-2016 Catalogue

工业缝纫机针位组
GAUGE SET FOR INDUSTRIAL SEWING MACHINES
INDUSTRIAL SEWING MACHINE SPARE PARTS



FOR BROTHER/兄弟

LT2-B842											
-1		-3		-5							
1/8		3/16 1/4		1/16 1/8							
1-1	 114950-001	1-2	 112603-001 112604-001	1-3	 142111-001 114950-001	117369-001					
2-1	 S07880-001	2-2	 S07878-001 S07879-001	2-3	 151078-001 114951-001						
3-1	 114948-001	3-2	 S36544-001	3-3	 112638-001 112642-001	3-4	 S36546-001 S36548-001	3-5	 151076-001 114948-001	3-6	 S36544-001
4-1	 158794-101	4-2	 158791-101 158792-101	4-3	 158806-001 158794-101						



FOR BROTHER/兄弟

LT2-B842											
-3		-5		-3							
5/32		3/16 1/4		5/16 3/8							
1-1		116503-001	150850-001	1-2		112603-001 112604-001	117133-001 117367-001	1-3		112605-001 116506-101	144882-001 144881-101
2-1		116509-001	2-2		112659-001 112660-001	2-3		112661-001 116510-101			
3-1		116502-001	3-2		112638-001 112642-001	3-3		S36546-001 S36548-001	3-4		112645-001 116498-001
4-1		158796-101	4-2		158791-101 158792-101	4-3		158793-101 158798-101			



FOR BROTHER/兄弟

LT2-B842												
-3		-5		-3		-7						
7/16 1/2 5/8		1/2 5/8		1 1 1/4 1 1/2		1/8						
1-1		151596-001 116505-001 116507-001	159577-001	1-2		147176-001 116504-001 118945-001	1-3		117369-001			
2-1		151598-001 116511-001 116512-001	116511-001 116512-001	2-2		147178-001 116508-001 118947-001	2-3		158430-001			
3-1		151597-101 118499-101 116500-101	116499-101 116500-101	3-2		147177-101 116501-101 118946-101	3-3		114948-001	3-4		S36544-001
4-1		158809-101 158797-101 158795-101	158797-101 158795-101	4-2		158805-101 158799-101 158800-101	4-3		158794-101			



FOR BROTHER/兄弟

LT2-B842			
-7 3/16 1/4	-7 3/8	-7 1/2 5/8	-7 1
1-1  117133-001 117367-001	1-2  144881-101	1-3  S09365-001 159577-001	1-4  147176-001
2-1  S13588-001 153882-001	2-2  153887-001	2-3  153892-001 153897-001	2-4  153907-001
3-1  112638-001 112642-001	3-2  S36546-001 S36548-001	3-3  116498-001	3-4  116499-101 116500-101
3-5  147177-101			
4-1  158791-101 158792-101	4-2  158798-101	4-3  158797-101 158795-101	4-4  158805-101



FOR BROTHER/兄弟

LT2-B845			
-1 1/8	-1 3/16 1/4	-3/-5 1/8 5/32	-7 1/8
1-1  117369-001	1-2  117133-001 117367-001	1-3  117369-001 150850-001	117369-001
2-1  S07880-001	2-2  S07878-001 S07879-001	2-3  114951-001 116509-001	158430-001
3-1  114948-001	3-2  112638-001 112642-001	3-3  S36546-001 S36548-001	3-4  114948-001 116502-001
4-1  S15711-001	4-2  S15723-001 S15735-001	4-3  S15711-001 S15717-001	S15711-001
5-1  S15712-001	5-2  S15724-001 S15736-001	5-3  S15712-001 S15718-001	S15712-001



FOR BROTHER/兄弟

LT2-B845													
-3/-5		-7		-7									
3/16 1/4		3/16 1/4		5/16 3/8									
-3/-5		-7		-3/-5									
7/16 1/2 5/8		3/8		1/2 5/8									
1-1		117133-001 117367-001	117133-001 117367-001	1-2		144882-001 144881-101	144881-101	1-3		151596-001 S09365-001 159577-001	S09365-001 159577-001		
2-1		112659-001 112660-001	S13588-001 153882-001	2-2		112661-001 116510-101	153887-001	2-3		151598-001 116511-001 116512-001	153892-001 153897-001		
3-1		112638-001 112642-001	3-2		S36546-001 S36548-001	3-3		112645-001 116498-001	116498-001	3-4		151597-101 118499-101 116500-101	116499-101 116500-101
4-1		S15723-001 S15735-001	4-2		S15747-001 S15753-001	S15753-001	4-3		S15759-001 S15765-001 S15771-001	S15765-001 S15771-001			
5-1		S15724-001 S15736-001	5-2		S15748-001 S15754-001	S15754-001	5-3		S15760-001 S15766-001 S15772-001	S15766-001 S15772-001			



FOR BROTHER/兄弟

LT2-B845								
-5-UT		-5-UT		-5-UT				
1/8		3/16 1/4 5/16		3/8 1/2 5/8				
1-1		155722-001	1-2		155851-001 155853-001 155855-001	1-3		155857-001 149677-001 149954-001
2-1		148699-001	2-2		148703-001 148705-001 149691-001	2-3		149938-001 149675-001 149948-001
3-1		148681-001	3-2		S36522-001	3-3		148691-001 148695-001 149687-001
			3-4		S36566-001 S36560-001	3-5		149940-001 149671-101 149950-101
4-1		S15711-001	4-2		S15723-001 S15735-001 S15747-001	4-3		S15753-001 S15765-001 S15771-001
5-1		S15712-001	5-2		S15724-001 S15736-001 S15748-001	5-3		S15754-001 S15766-001 S15772-001



工业缝纫机针位组
GAUGE SET FOR INDUSTRIAL SEWING MACHINES
INDUSTRIAL SEWING MACHINE SPARE PARTS









FOR BROTHER/兄弟

LT2-B875				
-5-UT 1/8	-5-UT 3/16 1/4 5/16	-5-UT 3/8 1/2 5/8		
1-1  155722-001	1-2  155851-001 155853-001 155855-001	1-3  155857-001 149677-001 149954-001		
2-1  148689-001	2-2  148703-001 148705-001 149691-001	2-3  149938-001 149675-001 149948-001		
3-1  155463-001	3-2  S36562-001	3-3  155457-001 155453-001 155459-001	3-4  S36564-001 S36566-001	3-5  155461-001 S09367-101 159575-101
4-1  S15711-001	4-2  S15723-001 S15735-001 S15747-001	4-3  S15753-001 S15765-001 S15771-001		
5-1  S15712-001	5-2  S15724-001 S15736-001 S15748-001	5-3  S15754-001 S15766-001 S15772-001		



工业缝纫机针位组
GAUGE SET FOR INDUSTRIAL SEWING MACHINES
INDUSTRIAL SEWING MACHINE SPARE PARTS

FOR BROTHER/兄弟

DT6-B927-8 4.8 (3/16) 薄料、中厚料 Thin materials Medium materials	DT6-B927 6.4 (1/4) 中厚料 Medium materials	DT6-B928 6.4 (1/4) 特厚料 Extra heavy materials	DT6-B928-7 3.2x2(1/8 x 2) 厚料 Heavy materials	DT6-B928-6 3.2x2(1/8 x 2) 特厚料 Extra heavy materials
1-1  S05946-101	1-2  S11508-101	1-3  150666-001	1-4  148864-001	1-5  150667-001
2-1  S40369-001	2-2  S40370-001	2-3  150673-001	2-4  148867-101	2-5  150675-101
3-1  S40355-101	3-2  S40363-101	3-3  150668-101	3-4  148865-201	3-5  150672-101
4-1  183954-001	4-2  183978-001	4-3  181716-001		
5-1  S06310-001	5-2  148973-001	5-3  148875-001		
6-1  148876-001-0			1:111443003 2:062671012 3:021670102 4:148876-001	

FOR BROTHER/兄弟

FOR BROTHER/兄弟

EF4-B511-01		EF4-B531		MA4-B551			EF4-N11	
0×3 0×5	0×4 0×6	5(2.2×5) 5(2.2×6)	6(2.2×5) 6(2.2×6)	063 064	(3×3) (3×4) (3×5)	065(5×5)	067(5×5) 092(5×5)	01-4 01-5
1-1	1-2	1-3	1-4	1-5	1-6			
146730-001 146731-001 146732-001 146733-001	146781-001 146782-001	146501-001 146502-001 146503-001	146504-001	146510-001	S19145-001 S19146-001			
2-1	2-2	2-3	2-4	2-5	2-6			
146748-001	156036-001	146572-001	146573-001	146574-001	S19236-001			
3-1	3-2	3-3	3-4	3-5				
146744-001 146577-001	146567-001 146577-001	146568-001 146577-001	146569-001 146577-001	S19199-001				
4-1	4-2	4-3	4-4	4-5	4-6			
146884-001	146902-001	146871-101	146674-001	148013-101	S20494-001			
5-1	5-2	5-3	5-4					
	146773-001	146489-001	146491-001					

EF4-N11			EF4-N21		
01-4(B)(0×4) 01-5(B)(0×5)	01-5(C)(0×5)	07-2	22-4 (2.2×4) 22-5 (2.2×5)	27-5 (2.2×5)	41-5 (2.2×5)
1-1	1-2	1-3	1-4		
S19154-001	S19155-001	S19153-001	S25190-001 S19162-001	S19166-001	
2-1	2-2	2-3	2-4	2-5	
S19240-001	S25574-001	S19240-001	S19237-101	S19240-001	
3-1	3-2	3-3	3-4	3-5	
S19212-001	S19210-001	S19217-001	S19202-001	S19212-001	
4-1	4-2	4-3	4-4	4-5	4-6
S20494-001 S19260-001	S20494-001 S29948-001	S20494-001 S19271-001	S20494-001 S25543-001	S20494-001 S19287-201	S20494-001 S19293-001
5-1	5-2				
	146491-001				
		5-2			
		S20398-001			



工业缝纫机针位组

GAUGE SET FOR INDUSTRIAL SEWING MACHINES

INDUSTRIAL SEWING MACHINE SPARE PARTS

FOR BROTHER/兄弟

EF4-N21	MA4-N31		MA4-N31 FB-N310	
45-5 (2.2 × 5)	63-3(3×3) 63-5(3×5) 63-4(3×4) 63-5(3×7)	65-5(5×5) 65-6(5×6)	92-5 92-6 92-7	5050-55-E3W(5×5) 5050-56-E3W(5×6) 5050-57-E3W(5×7) 4050-55-E3W(5×5) 4050-56-E3W(5×6) 4050-57-E3W(5×7)
1-1  S19169-001	1-2  S20234-001 S20235-001 S20236-001 S25196-001	1-3  S20232-001 S20233-001	1-4  S19185-001 S19188-001 S19187-001	
2-1  S19244-101	2-2  S20245-001	2-3  S20244-001	2-4  S19247-001	2-5  S38597-001
3-1  S19219-001	3-2  S20242-001 S20243-001 S20241-101	3-3  S20240-001 S19223-101 S20239-101	3-4  S19229-001 S19223-101 S19228-101	3-5  S38596-001 S19223-101 S38595-001
4-1  S20494-001 S19297-001	4-2  S19313-201	4-3  S19317-101 S19318-101	4-4  S19334-001	4-5  S30525-001
5-1  S20398-001	5-2  S20404-001	5-3  S20406-001	5-4  S21104-001	



工业缝纫机针位组

GAUGE SET FOR INDUSTRIAL SEWING MACHINES

INDUSTRIAL SEWING MACHINE SPARE PARTS

FOR JUKI/重机

LH-3528A-7		LH-3568A-7	
1/8 5/32	3/16 1/4 5/16	3/8	1/8 5/32
1-1  400-35881 400-25485	1-2  400-25490 400-25492 400-25494	1-3  400-25495	1-4  400-35881 400-25485
2-1  400-35890 400-25817	2-2  400-25818 400-26715 400-25821	2-3  400-25822	2-4  400-35890 400-25817
3-1  400-35896 400-35897	3-2  226-40353 226-40551 226-40858	3-3  400-95293 400-94776	3-4  226-40957
3-5  400-35896 400-35897	4-1  101-47650 101-47759	4-2  101-47858 101-48054 101-48252	4-3  101-48351
4-4  B1402-528-BA0-A B1402-528-CA0-A	5-1  B1402-528-BA0-A B1402-528-CA0-A		



工业缝纫机针位组
GAUGE SET FOR INDUSTRIAL SEWING MACHINES
INDUSTRIAL SEWING MACHINE SPARE PARTS







FOR JUKI/重机

LH-3568A-7		LH-3588A-7	
1-1 3/16 1/4 5/16	1-2 3/8 1/2 5/8 3/4	1-3 1/8 5/32	
 400-25490 400-25492 400-25494	 400-25495 400-25498 400-25499 400-25500	 400-35881 400-25485	
2-1  400-25818 400-26715 400-25821	2-2  400-25822 400-25824 400-25825 400-25826	2-3  400-53705 400-71911	
3-1  226-40353 226-40551 226-40858	3-2  400-95293 400-94776	3-3  226-40957 226-41252	3-4  400-35896 400-71909
4-1  B1402-528-DAL-A B1402-528-FAL-A B1402-528-HAL-A	4-2  B1402-528-KAL-A B1402-528-LAL B1402-528-MAL B1402-528-NAL	4-3  B1402-528-BA0-A B1402-528-CA0-A	
5-1  B1402-528-DAR-A B1402-528-FAR-A B1402-528-HAR-A	5-2  B1402-528-KAR-A B1402-528-LAR B1402-528-MAR B1402-528-NAR	5-3  B1402-528-BA0-A B1402-528-CA0-A	



工业缝纫机针位组
GAUGE SET FOR INDUSTRIAL SEWING MACHINES
INDUSTRIAL SEWING MACHINE SPARE PARTS

FOR JUKI/重机

LH-3588A-7			MH-380	
1-1 3/16 1/4 5/16	1-2 3/8 1/2 5/8 3/4		1-3 1X0	1-4 2X1/8 2X5/32
 400-95289 400-94773 400-25494	 400-25495 400-25498 400-25499 400-25500		 12515016	 B1103-380-B00 B1103-380-C00
2-1  400-35891 400-35892 400-50011	2-2  400-35893 400-35894 400-25839 400-35895		2-3  12514006	2-4  B1613-380-B00 B1613-380-C00
3-1  228-16557 228-16755 228-16953	3-2  400-95293 400-94776	3-3  228-17050 228-17159 400-33845 400-33847	3-4  1251601000	3-5  B1509-038-BB0 B1509-038-CB0
4-1  B1402-528-DAL-A B1402-528-FAL-A B1402-528-HAL-A	4-2  B1402-528-KAL-A B1402-528-LAL B1402-528-MAL B1402-528-NAL		4-3  B1406-019-BA0 B1406-019-CA0	
5-1  B1402-528-DAR-A B1402-528-FAR-A B1402-528-HAR-A	5-2  B1402-528-KAR-A B1402-528-LAR B1402-528-MAR B1402-528-NAR			



工业缝纫机针位组

GAUGE SET FOR INDUSTRIAL SEWING MACHINES

INDUSTRIAL SEWING MACHINE SPARE PARTS

FOR JUKI/重机

MH-380

2*3/16 2*7/32	2*1/4 2*5/16	2*3/8 2*1/2	3*1/8 3*3/16 3*1/4	3*1/8 (拖布轮)	3*1/4
1-1 B1103-380-D00 B1103-380-E00	1-2 B1103-380-F00 B1103-380-H00	1-3 B1103-380-K00 B1103-380-L00	1-4 12615004 NE388 NE387	1-5 12605004	1-6 NE389
2-1 B1613-380-D00 D1613-380-E00	2-2 B1613-380-F00 D1613-380-H00	2-3 B1613-380-K00 D1613-380-L00	2-4 12614002 FE247 FE246	2-5 12614004	2-6 FE248
3-1 B1509-038-DB0 B1509-038-EB0	3-2 B1509-038-FB0 B1509-038-HB0	3-3 B1509-038-KB0 B1509-038-LBB	3-4 126100600 PE227 PE226	3-5 1261601000	3-6 PE228
4-1 B1406-019-DA0 B1406-019-EA0	4-2 B1406-019-FA0 B1406-019-HA0	4-3 B1406-019-KA0 B1406-019-LA0	4-4 12634002 TE3059 TE3058	4-5 12634004	4-6 TE3060



工业缝纫机针位组

GAUGE SET FOR INDUSTRIAL SEWING MACHINES

INDUSTRIAL SEWING MACHINE SPARE PARTS

FOR JUKI/重机

MS-1190	MO-2414N	MO-2504		
3/16	BE6(2x4)	OA4-150 OA4-150-FG (0x1.6)	OD4 OD4-FG(0x3.2) OE4-300(0x4)	OD4-200(0x3.2)
1-1 129-23405	1-2 R4305-HOE-E00	1-3 R4200-HOA-C00	1-4 R4200-HOE-D00	1-5 R4200-HOD-D00
2-1 129-32307	2-2 118-86504	2-3 B1657-804-00T		
	3-1 118-82404 118-87106	3-2 118-82107 118-87007	3-3 118-82107 118-87106	
4-1 129-27760	4-2 118-76851	4-3 118-76059	4-4 118-76158	4-5 118-81455
5-1 129-25954	5-2 118-69658	5-3 118-69005		



工业缝纫机针位组
GAUGE SET FOR INDUSTRIAL SEWING MACHINES
INDUSTRIAL SEWING MACHINE SPARE PARTS

















FOR JUKI/重机

MO-2504		MO-2514		MO-2516
OD6-300 (0×3.2)	BO6-340 (2×3.2)	BD4-200 BD4-200-FG	BD4(2.0×3.2) BD4-FG	DD4-300(3.2×3.2) DF4-300(3.2×4.8)
1-1  R4300-HOD-E00	1-2  R4305-HOD-E00	1-3  R4205-HOD-E00	1-4  R4205-HOD-EA0	1-5  R4508-HOD-D00 R4508-HOF-D00
2-1  118-85100	2-2  118-86504	2-3  B1657-814-B0E	2-4  118-85209	
3-1  118-82206 118-87106	3-2  118-82404 118-87106	3-3  115-97101 118-87106	3-4  118-82800 118-87403	
4-1  118-76356	4-2  118-79251	4-3  118-81554	4-4  118-76851	4-5  118-77552
5-1  118-69005	5-2  118-69658	5-3  118-70359		



工业缝纫机针位组
GAUGE SET FOR INDUSTRIAL SEWING MACHINES
INDUSTRIAL SEWING MACHINE SPARE PARTS

FOR JUKI/重机

MO-2516	MO-2543	MO-3304E		
FF6-500 (4.8×4.8)	FBDB-300 FBD6-300-FG (4.8×2.0×3.2)	OE4-40H (0×3.6)	OF6-50H (0×4.8)	DE4-40H/Z192 (0×3.1)
1-1  R4612-HOF-G00	1-2  R4612-HOD-E01	1-3  R4200-LOE-E00	1-4  R4300-LOF-E00	1-5  R4200-L2E-E00
2-1  118-85407	2-2  118-86009	2-3  124-78004	2-4  124-78806	2-5  124-79101
3-1  118-83006 118-87304	3-2  118-84004 118-87403	3-3  12476008 12480000 12478004 124760A6 12476008 12480000	3-4  12476701 12480109 12478806 124767A9 12476701 12480109	3-5  12476800 12480000 12479101 124768A8 12476800 12480000
4-1  118-77750	4-2  118-78055	4-3  124-66058		
5-1  118-70458	5-2  118-70854	5-3  124-65001	5-4  124-65100	



工业缝纫机针位组

GAUGE SET FOR INDUSTRIAL SEWING MACHINES

INDUSTRIAL SEWING MACHINE SPARE PARTS

FOR JUKI/重机

MO-3305E	MO-3314E		MO-3316E		
OE4-41H/L121 (0 x 3.4)	BE6-44H/G41/Q146 (2.2 x 3.6) BE6-40H(2.2 x 3.6)		BE6-42H/S170 (2.2 x 3.6)	DE4-40H (3 x 3.8)	DE6-40H (3 x 3.8)
1-1  R4200-LOE-D00	1-2  R4305-LOE-E00	1-3  R4305-LOE-E0A	1-4  R4508-LOE-G00	1-5  R4608-LOE-G00	
2-1  124-78301	2-2  124-78103	2-3  124-78707	2-4  124-78202	2-5  124-78905	
3-1  12476305 12480307 12478301 124783A3 12476305 12480307	3-2  12476107 12480109 12478103 124761A5 12476107 12480109	3-3  12476602 12480109 12478707 124766A0 12476602 12480109	3-4  12476206 12480208 12478202 124762A4 12476206 12480208		
4-1  12466157	4-2  12466850	4-3  12466553	4-4  12466751	4-5  12470050	
5-1  124-85100			5-2  124-85407		



工业缝纫机针位组

GAUGE SET FOR INDUSTRIAL SEWING MACHINES

INDUSTRIAL SEWING MACHINE SPARE PARTS

FOR JUKI/重机

MO-3316E			MO-3343	MO-3904	MO-3914
DE6-42H/S169 (3 x 3.8)	FF6-40H (4.8 x 4.8)	FF6-60H(4.8 x 4.8) FH6-60H(4.8 x 6) FH6-50H(4.8 x 6)	(4.8 x 2.2 x 3.2)	OE4(0 x 4.0) OE4-FG(0 x 4.0)	BE6(2.0 x 4.0) BE6-FG(2.0 x 4.0)
1-1  R4608-LOE-G0A	1-2  R4612-LOF-G00	1-3  R4612-LOF-L00 R4612-LOH-L00 R4612-LOH-G00	1-4  R4612-LOD-E01	1-5  R4200-JOE-D00	1-6  R4305-JOE-E00
2-1  124-78608	2-2  124-78400	2-3  124-78509	2-4  124-78905	2-5  B1657-804-OOT	2-6  119-49906
3-1  12476503 12480406 12478608 124765A1 12476503 12480406	3-2  12476206 12480208 12478400 124762C0 12476206 12480208	3-3  12476404 12480208 12478509 124764A2 12476404 12480208	3-4  12476206 12480208 12478905 124762B2 12476206 12480208	3-5  118-82107 118-87106	3-6  119-49807 118-87106
4-1  12470357	4-2  12470159	4-3  12470258	4-4  12473153	4-5  118-76158	4-6  121-52450
5-1  124-85407	5-2  124-85506	5-3  124-85805		5-5  118-76156	5-6  121-52468
				6-1  121-48607	6-2  121-48706



工业缝纫机针位组
GAUGE SET FOR INDUSTRIAL SEWING MACHINES
INDUSTRIAL SEWING MACHINE SPARE PARTS

FOR JUKI/重机

MO-3916		MO-3943	MO-6704	MO-6714
OE4(3.2 × 4.0) OE4-FG(3.2 × 4.0)	DE6(3.2 × 4.0)	FF6(4.8 × 4.8) FF6-FG(4.8 × 4.8)	FBD6-347/G07/Q141 (4.8 × 2 × 3.2)	OE4-40H (0 × 4.0)
1-1	1-2	1-3	1-4	1-5
R4508-JOE-D00	R4608-JOE-D00	R4612-JOF-D00	R4612-J0D-E01	R4200-J6E-D00
2-1	2-2	2-3	2-4	2-5
121-72805	121-73209	121-73308	131-92802	121-72003
3-1	3-2	3-3	3-4	3-5
118-82800 118-87403	118-82909 118-87106	118-84004 118-87403	131-91606 131-91309	121-71500 118-87106
4-1	4-2	4-3	4-4	4-5
121-53755	121-54258	118-81257	118-76158	118-76851
5-1	5-2	5-3	5-4	5-5
121-53763	121-54266	118-81265	118-76166	118-76869
6-1	6-2	6-3	6-4	6-5
121-49803	121-50306	121-50603	121-48607	122-75509



工业缝纫机针位组
GAUGE SET FOR INDUSTRIAL SEWING MACHINES
INDUSTRIAL SEWING MACHINE SPARE PARTS

FOR JUKI/重机

MO-6714	MO-6716		MO-6743	MO-814
BE4-40H (2 × 4.0)	DE6-40H (3.2 × 4.0)	FF6-40H (4.8 × 4.8)	FH6-60H	ID6-40H (4.8 × 2 × 3.2)
1-1	1-2	1-3	1-4	1-5
R4205-J6E-E00	R4608-J6E-D00	R4612-J6F-D00	R4612-J6H-K00	R4612-J6D-E01
2-1	2-2	2-3	2-4	2-5
B1657-814-B0E	121-73209	121-73308	121-74207	121-73308
2-6				
B1657-804-00C				
3-1	3-2	3-3	3-4	3-5
115-97101 118-87106	118-82909 118-87403	118-84004 118-87403	121-71104 118-87403	118-84004 118-87403
3-6				
B1656-804-000 B1658-804-000				
4-1	4-2	4-3	4-4	4-5
118-76851	121-53755	121-54258	121-55552	118-78055
4-6				
B1507-814-0A0				
5-1	5-2	5-3	5-4	5-5
118-76869	121-53763	121-54266	121-55560	118-78063
6-1	6-2	6-3	6-4	6-5
122-75509	122-57507	121-50702	122-75004	B1420-714-B00



工业缝纫机针位组

GAUGE SET FOR INDUSTRIAL SEWING MACHINES

INDUSTRIAL SEWING MACHINE SPARE PARTS

FOR KANSAI SPECIAL/关西

UK2004S-20F	UK2005S-10M	UK2004S-01M	UK2014H-01M	UK2014H-40M	UK-2116S-01M UK-2116S-02M
0×1.5	0×3 0×4	0×4	2×4 2×5	2×4 2×5	3×4 3×5
1-1  57-031	1-2  57-011 57-021	1-3  57-001	1-4  57-041 57-051	1-5  57-061 57-071	1-6  57-002
2-1  57-211		2-2  57-201		2-3  57-202	
3-1  57-115 57-126 57-1210-1	3-2  57-115 57-116 57-1110-1	3-3  57-105 57-106 57-1010-1	3-4  57-105 57-116 57-1310-1	3-5  57-107 57-108 57-1020-1	
4-1  57-3210-1	4-2  57-3110-1	4-3  57-3010-1	4-4  57-3310-1	4-5  57-3410-1	4-6  57-3020-1 57-3120-1
5-1  57-503		5-2  57-505		5-3  57-504	























工业缝纫机针位组

GAUGE SET FOR INDUSTRIAL SEWING MACHINES

INDUSTRIAL SEWING MACHINE SPARE PARTS

FOR KANSAI SPECIAL/关西

UK-2116S-30M	UK-2116S-30M	UK-2116S-01H	UK-2116H-03X	UK-2143H-90M
3×4	5×5	5×5	5×5 5×6	3×2×4
1-1  57-042	1-2  57-012	1-3  57-022 57-032	1-4  57-052	
2-1  57-232	2-2  57-212	2-3  57-222	2-4  57-242	
3-1  57-137 57-108 57-1320-1	3-2  57-147 57-108 57-1420-1	3-3  57-117 57-108 57-1120-1	3-4  57-127 57-118 57-1220-1	3-5  57-117 57-108 57-1120-1
4-1  57-3420-1	4-2  57-3520-1	4-3  57-3220-1	4-4  57-3320-1	4-5  57-3620-1
5-1  57-504	5-2  57-506	5-3  57-507		



工业缝纫机针位组

GAUGE SET FOR INDUSTRIAL SEWING MACHINES

INDUSTRIAL SEWING MACHINE SPARE PARTS

FOR KANSAI SPECIAL/关西

DVK1702B B2000	WX8700D WX8800D	RX9700D RX9800D	RX9700A RX9800A	WX8800DW	PX302-4W	LX5802M
(2×6.4)	(3×5.6) (3×6.4)	(3×5.6) (3×6.4)	(3×5.6) (3×6.4)	(1/4×3N)		2×6.4
1-1  14-763	1-2  14-890 14-891	1-3  14-880	1-4  14-3310-1 14-3320-1 14-3330-1 14-3010-1	1-5  14-563		
2-1  15-704	2-2  15-805 15-807	2-3  15-855 15-857	2-4  15-870	2-5  15-361	2-6  15-536	
	3-1  15-843 15-844	3-2  15-856 15-858	3-3  15-875	3-4  15-301	3-5  15-535	
4-1  17-7620-1	4-2  17-7680-1 17-7690-1	4-3  17-7690-1	4-4  17-3610-1	4-5  17-5630-1		
5-1  12-2290-1	5-2  12-8380-1 12-8390-1	5-3  12-8180-1 12-9190-1	5-4  12-8190-1	5-5  12-3150-1	5-6  12-5630-1	











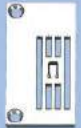
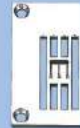
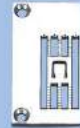
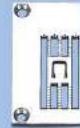

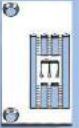





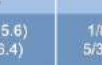
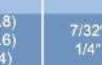
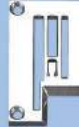
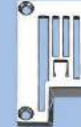

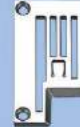
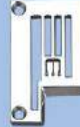
工业缝纫机针位组

GAUGE SET FOR INDUSTRIAL SEWING MACHINES

INDUSTRIAL SEWING MACHINE SPARE PARTS

FOR KANSAI SPECIAL/关西

DVK1702D V7002D	DWK1802D W8002D	DVK1703D/V7003D DVK1803D/W8003D	DVK1702DE V7002DE	DWK1802DE W8002DE	DVK1703DE/V7003DE DVK1803DE/W8003DE						
1/8" (2×3.2) 5/32" (2×3.2)	3/16" (2×4.8) 7/32" (2×5.6) 1/4" (2×6.4)	7/32" (3×5.6) 1/4" (3×6.4)	1/8" (2×3.2) 5/32" (2×4.0)	3/16" (2×4.8) 7/32" (2×5.6) 1/4" (2×6.4)	7/32" (3×5.6) 1/4" (3×6.4)						
1-1  14-724 14-734	1-2  14-744 14-754 14-764	1-3  14-854 14-864	1-4  14-725 14-735	1-5  14-745 14-755 14-765	1-6  14-855 14-865						
2-1  15-724	2-2  15-723	2-3  15-724	2-4  15-723								
3-1  15-755	3-2  15-753	3-3  15-755	3-4  15-753								
DVK1702F DVK1802F V7002F		DVK1703F DVK1803F V7003F		WX8802F		WX8803F					
1/8" (2×3.2) 5/32" (2×4.0)		3/16" (2×4.8) 7/32" (2×5.6) 1/4" (2×6.4)		7/32" (3×5.6) 1/4" (3×6.4)		1/8" (2×3.2) 5/32" (2×4.0)		3/16" (2×4.8) 7/32" (2×5.6) 1/4" (2×6.4)		7/32" (3×5.6) 1/4" (3×6.4)	
4-1  14-726 14-736	4-2  14-746 14-756 14-766	4-3  14-856 14-866	4-4  14-726 14-736	4-5  14-746 14-756 14-766	4-6  14-856 14-866						
5-1  15-729	5-2  15-726 (15-727)	5-3  15-813	5-4  15-811								
6-1  15-758	6-2  15-756	6-3  15-814	6-4  15-812								

FOR KANSAI SPECIAL/关西

WX8802D	WX8803C	WX8703D WX8803D	DVK1702E	DVK1703E	1503PHD
2 × 3.2 2 × 4.0 2 × 4.8	7/32" (3 × 5.6) 1/4" (3 × 6.4)	7/32" (3 × 5.6) 1/4" (3 × 6.4)	3/16" (2 × 4.8) 7/32" (2 × 5.6) 1/4" (2 × 6.4)	7/32" (3 × 5.6) 1/4" (3 × 6.4)	1/4"
1-1 14-806 14-807 14-808	1-2 14-860 14-862	1-3 14-820 14-819	1-4 14-745 14-755 14-765	1-5 14-855 14-865	1-6 14-553
2-1 15-805	2-2 15-823	2-3 15-807	2-4 15-704	2-5 15-553	
3-1 15-806	3-2 15-808	3-3	3-4		

FOR KANSAI SPECIAL/关西

DLR 1508P-E	DLR 1509P-E	1404P	
4x1/4*1*1/4	6x1/8*1/8*1*1/8*1/8	4x1 4x5/32 4x3/4	4x1-1/8 4x1-1/2
1-1 14-581	1-2 14-591	1-3 14-421 NE373 14-4180-1	1-4 14-422 14-424
2-1 15-581	2-2 15-591	2-3 15-421 FE244 15-4180-1	2-4 15-422 15-424
3-1 17-5810-1	3-2 17-5760-1	3-3 17-3710-1 PE224 17-3750-1	3-4 17-3720-1 17-3740-1
4-1 12-5810-1	4-2 12-591	4-3 12-4210-1 TE2989 12-4180-1	4-4 12-4220-1 12-4240-1
5-1	5-2	5-3 19-4210-1 TE2991 19-4180-1	5-4 19-4220-1 19-4240-1
		6-1 18-4210-1 TE2990 18-4180-1	6-2 18-4220-1 18-4240-1



工业缝纫机针位组

GAUGE SET FOR INDUSTRIAL SEWING MACHINES

INDUSTRIAL SEWING MACHINE SPARE PARTS

FOR KANSAI SPECIAL/关西

1404P

4x 3/16*5/8*3/16 3/16*7/8*3/16 3/16*3/4*3/16 3/16*1*3/16		4x 1/4*3/8*1/4 1/4*3/4*1/4 1/4*1/2*1/4 1/4*7/8*1/4 1/4*5/8*1/4 1/4*1*1/4		8x1/8 8x1/4	
1-1 	14-437 14-426	14-436 14-432	1-2 	NE333 14-428 14-429	14-427 14-4301 14-431
2-1 	15-437 15-426	15-436 15-432	2-2 	FE224 15-428 15-429	15-427 15-4301 15-431
3-1 	PE214 17-3760-1	PE215 17-3820-1	3-2 	PE211 17-4280-1 PE212	17-3770-1 PE213 17-3810-1
4-1 	12-4370-1 12-4260-1	12-4360-1 12-4300-1	4-2 	TE2905 12-4280-1 12-4380-1	12-4270-1 12-4301-1 12-4290-1
5-1 	19-4320-1 19-4260-1	19-4360-1 19-4300-1	5-2 	TE2907 12-4280-1 12-4380-1	12-4270-1 12-4301-1 12-4290-1
6-1 	18-4370-1 18-4260-1	18-4360-1 18-4320-1	6-2 	TE2096 18-4280-1 18-4290-1	18-4270-1 18-4301-1 18-4310-1
			6-3 	18-D1/8*8 18-4650-1	



工业缝纫机针位组











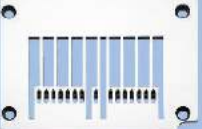





GAUGE SET FOR INDUSTRIAL SEWING MACHINES











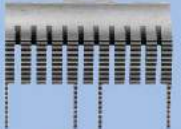

INDUSTRIAL SEWING MACHINE SPARE PARTS

FOR KANSAI SPECIAL/关西

1404P

11x1/8		11x1/8T		12x1/8 12x3/16 12x1/4	
1-1 	14-D1/8*11.N	1-2 	14-11T.N	1-3 	14-480.N 14-497.N 14-496.N
2-1 	15-D1/8*11	2-2 	15-11T	2-3 	15-480 15-497 15-496.N
3-1 	17-D1/8*11	3-2 	17-11T	3-3 	17-4780-1 17-3970-1 17-3960-1
4-1 	12-D1/8*11	4-2 	12-11T	4-3 	12-4780-1 12-4990-1 12-4980-1
5-1 	19-D1/8*11	5-2 	19-11T	5-3 	19-4140-1 19-4970-1 19-4960-1
6-1 	18-D1/8*11	6-2 	18-11T	6-3 	18-4800-1 18-4970-1 18-4960-1

1404P		
13x1/8T	15x1/8T	17x1/8
1-1  14-D1/8*13T.N	1-2  NE374	1-3  14-D1/8*17.N
2-1  15-D1/8*13T	2-2  FE245	2-3  15-D1/8*17
3-1  17-D1/8*13T	3-2  PE225	3-3  17-D1/8*17
4-1  12-D1/8*13T	4-2  TE2992	4-3  12-D1/8*17
5-1  19-D1/8*13T	5-2  TE2994	5-3  19-D1/8*17
6-1  18-D1/8*13T	6-2  TE2993	6-3  18-D1/8*17

1404P	
17x1/8T	21x1/8
1-1  14-17T.N.A	1-2  14-D1/8*21.N
2-1  15-17T	2-2  15-D1/8*21
3-1  17-17T	3-2  17-D1/8*21
4-1  12-17T	4-2  12-D1/8*21
5-1  19-17T	5-2  19-D1/8*21
6-1  18-17T	6-2  18-D1/8*21



FOR KANSAI SPECIAL/关西

1412P		
4x1	6x 3/16 6x 1/4	6x 5/16 6x 3/8 6x 1/2
1-1 14-D1*4	1-2 14-442 14-443	1-3 14-445 14-454 14-D1/2*6 14-464
2-1 15-421	2-2 15-442 15-443	2-3 15-445 15-454 15-D1/2*6 15-464
3-1 17-3710-1	3-2 17-3890-1 17-3900-1	3-3 17-4450-1 17-3910-1 17-D1/2*6 17-4640-1
4-1 12-4210-1	4-2 12-4420-1 12-4430-1	4-3 12-4450-1 12-4540-1 12-D1/2*6 12-4640-1
5-1 19-4210-1	5-2 19-4420-1 19-4430-1	5-3 19-4450-1 19-4540-1 19-D1/2*6 19-4640-1
6-1 18-4210-1	6-2 18-4420-1	6-3 18-4450-1 18-4640-1



FOR KANSAI SPECIAL/关西

1412P		1412PSSM
11x1/8T	12x1/8 12x3/16 12x1/4	12x3/16 12x1/4
1-1 14-D1/8*11T	1-2 14-D1/8*12 14-497 14-496	1-3 14-028 14-029
2-1 15-11T	2-2 15-480 15-497 15-496	2-3 15-046 15-047
3-1 17-11T	3-2 17-4780-1 17-3970-1 17-3960-1	3-3 17-0460-1 17-0470-1
4-1 12-11T	4-2 12-4780-1 12-4990-1 12-4980-1	12-4990-1 12-4980-1
5-1 19-11T	5-2 19-4140-1 19-4970-1 19-4960-1	19-4970-1 19-4960-1
6-1 18-11T	6-2 18-4800-1 18-4970-1 18-4960-1	18-4960-1 18-4970-1



工业缝纫机针位组

GAUGE SET FOR INDUSTRIAL SEWING MACHINES

INDUSTRIAL SEWING MACHINE SPARE PARTS

FOR KANSAI SPECIAL/关西

1412P

13x3/16



14-D3/16*13

15x1/8T



14-D1/8*15T

15x3/16



14-D3/16*15



15-D3/16*13



15-D1/8*15T

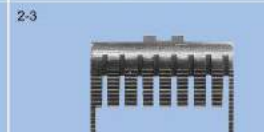

15-D3/16*15



17-D3/16*13



17-D1/8*15T



17-D3/16*15



12-D3/16*13



12-D1/8*15T



12-D3/16*15



19-D3/16*13



19-D1/8*15T



19-D3/16*15



18-D3/16*13



18-D1/8*15T



18-D3/16*15



工业缝纫机针位组

GAUGE SET FOR INDUSTRIAL SEWING MACHINES

INDUSTRIAL SEWING MACHINE SPARE PARTS

FOR KANSAI SPECIAL/关西

1412P

17x1/8
17x3/16



14-D1/8*17
14-D3/16*17

17x1/8T



14-17T



15-D1/8*17
15-D3/16*17

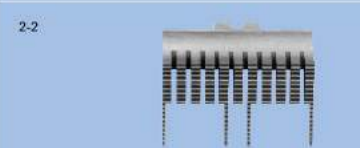

15-17T.A



17-D1/8*17
17-D3/16*17



17-17T



12-D1/8*17
12-D3/16*17



12-17T



19-D1/8*17
19-D3/16*17



19-17T



18-D1/8*17
18-D3/16*17



18-17T

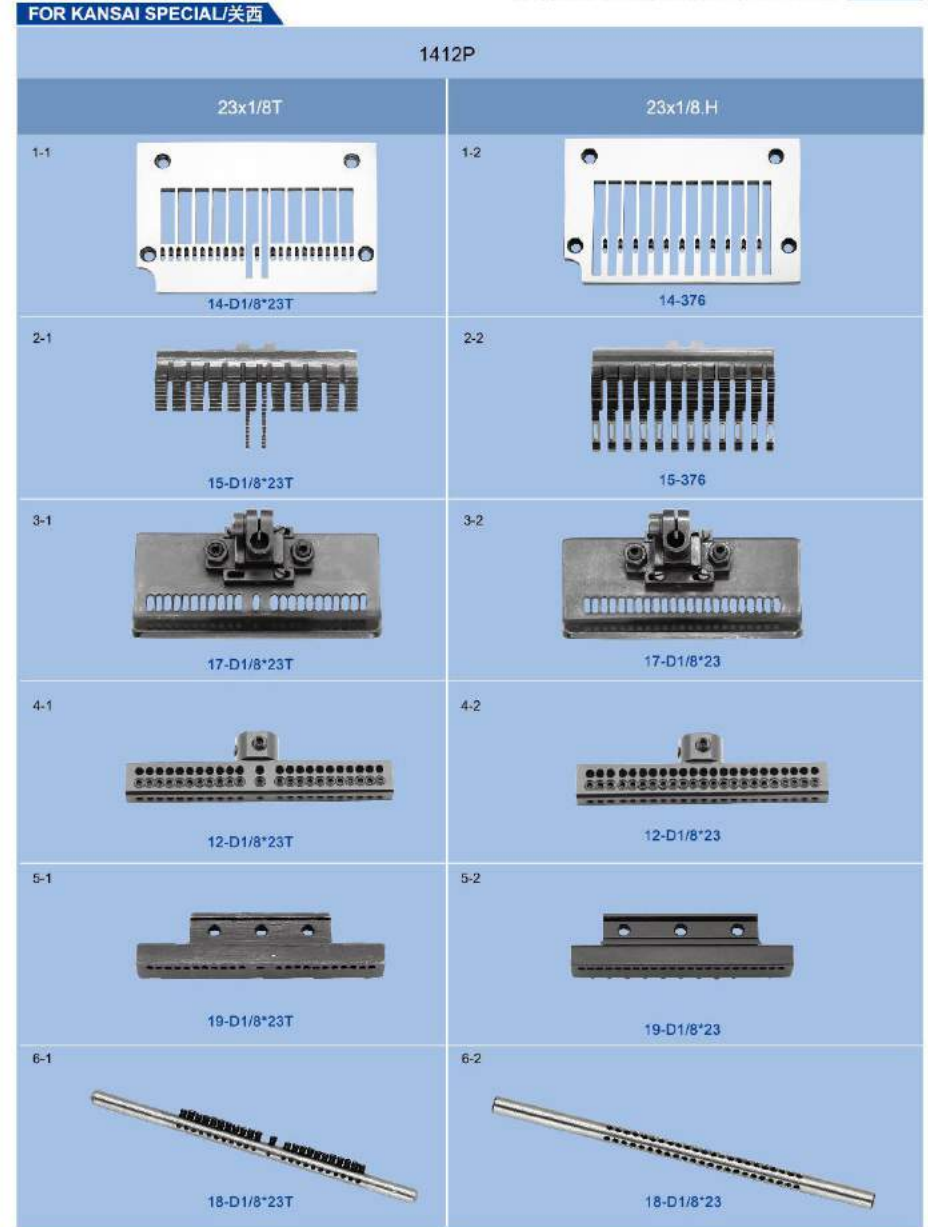
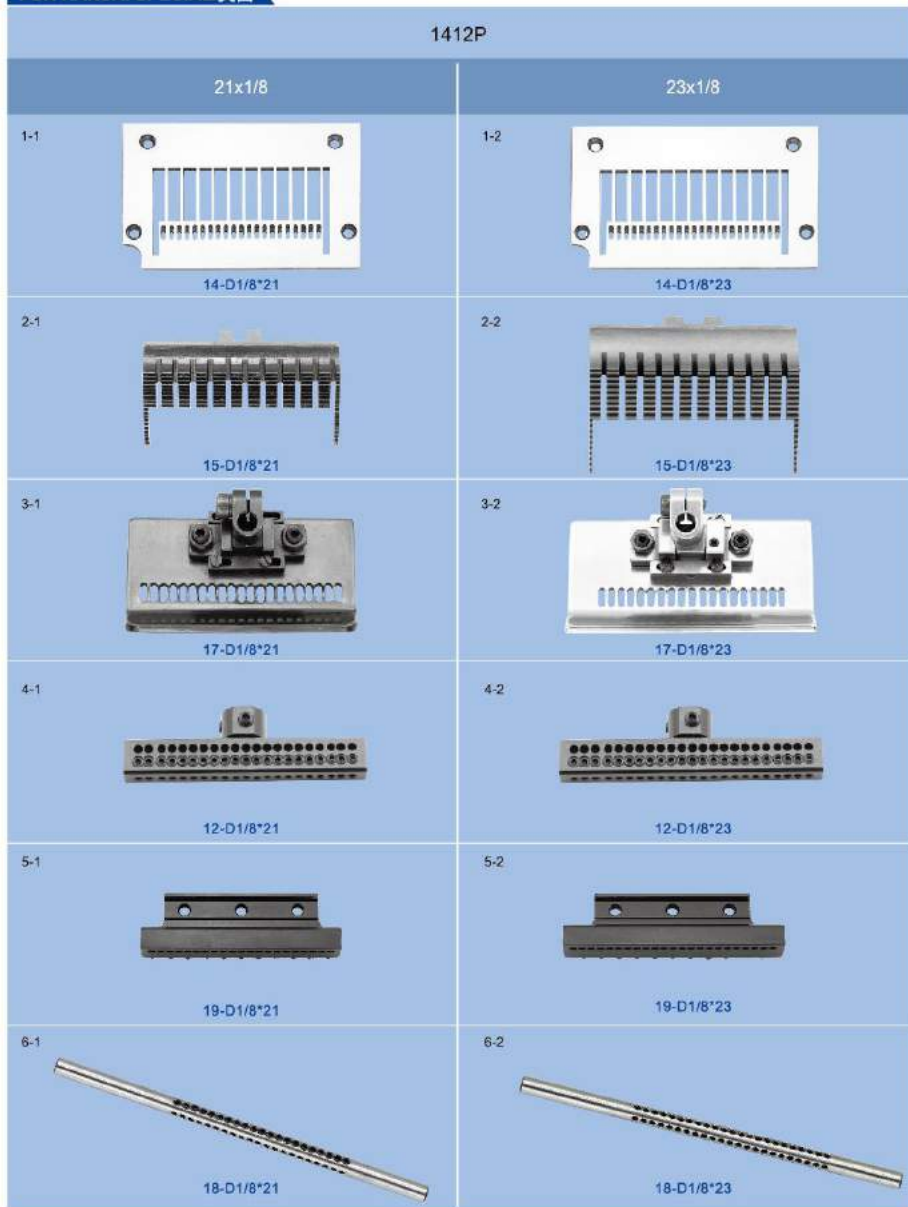



FOR KANSAI SPECIAL/关西

1412P

25x1/4



14-022

25x1/4.A



14-022.A

2-1



15-024

2-2



15-024.A

3-1



10-0250-0

4-1



12-0250-1

5-1



19-025

6-1



18-025



FOR KANSAI SPECIAL/关西

1412P

33x3/16



14-023

33x3/16.A



14-023.A

2-1

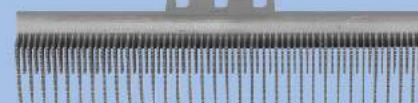

15-034

2-2



15-034.A

3-1



10-0300-0

4-1



12-0330-1

5-1



19-033

6-1



18-033



工业缝纫机针位组
GAUGE SET FOR INDUSTRIAL SEWING MACHINES
INDUSTRIAL SEWING MACHINE SPARE PARTS

FOR KINGTEX/宝狮

SH6005-C32-C52		SH6034-D03-M45		CT-8556		CT-9042		CTD-9085	
M16		M45		3x5.6 3x6.4		3x5.6 3x6.4		2x4.0 2x4.8	
3x5.6 3x6.4		3x5.6 3x6.4		2x4.0 2x4.8		3x5.6 3x6.4		3x5.6 3x6.4	
1-1	1-2	1-3	1-4	1-5	1-6				
2-1	2-2	2-3	2-4	2-5					
3-1	3-2	3-3	3-4	3-5					
4-1	4-2	4-3	4-4	4-5	4-6				
5-1	5-2	5-3	5-4	5-5	5-6				



工业缝纫机针位组
GAUGE SET FOR INDUSTRIAL SEWING MACHINES
INDUSTRIAL SEWING MACHINE SPARE PARTS

FOR KINGTEX/宝狮

FOR PEGASUS/飞马

CTD-9311		L52-01		L52-05		L52-05S1		L52-16	
2x4.0 2x4.8		3x5.6 3x6.4		0x3 0x4		2x3 2x4		2x3	
2x4.0 2x4.8		3x5.6 3x6.4		0x3 0x4		2x3 2x4		2x3	
1-1	1-2	1-3	1-4	1-5					
2-1	2-2	2-3	2-4						
3-1	3-2	3-3	3-4						
4-1	4-2	4-3	4-4	4-5	4-6				
5-1	5-2	5-3	5-4	5-5					



工业缝纫机针位组

GAUGE SET FOR INDUSTRIAL SEWING MACHINES

INDUSTRIAL SEWING MACHINE SPARE PARTS

FOR PEGASUS/飞马

L52-17	L52-13	L52-51 L52-52	L32-31	L32-34	L32-38
0×4	2×3 2×4	2×4	3×3 3×4	3×3 3×4	3×3 3×4 3×5
1-1	1-2	1-3	1-4		1-5
202546E	205255 202554E	205243	204294B 204039B		204366 204367 204368
2-1	2-2	2-3	2-4	2-5	
204676-BF	204676-BF	208215	208217	208219	
3-1	3-2	3-3	3-4	3-5	3-6
204675A 204674	204675A 204674	204675A 204677	204248B 208059	204394 208059	204396 208060
208078-BF	208078-BF	208079-BF	208063	208064	208066
4-1	4-2	4-3	4-4	4-5	
208525	208525	208525	208501	208504	
201230C/201224B	208730/208731 208730/208732	205253/201310A			
5-1	5-2	5-3			
209670-92	208905	208909			



工业缝纫机针位组

GAUGE SET FOR INDUSTRIAL SEWING MACHINES

INDUSTRIAL SEWING MACHINE SPARE PARTS

FOR PEGASUS/飞马

L32-48 F32-48 F32-49	L32-70	L32-76	L32-86	L32-359	M752-01
3×3 3×5	5×5 5×6	5×5	5×5 5×6	3×2×4	0×4
1-1	1-2	1-3	1-4	1-5	1-6
204939 204941	204360A 204361A	204380	204528 204529	208648	205773
2-1	2-2	2-3	2-4	2-5	2-6
204420	208215	208225	208217	208219	204730-BF
3-1	3-2	3-3	3-4	3-5	3-6
204931 208061	204248B 208059	204394 208059	204394 208059	204396 208060	204729ABF 204674
208074	208063	208064	208064	208066	208090-BF
4-1	4-2	4-3	4-4	4-5	4-6
208508	208502	208502	208506 208955	208649	201152E/201155C
5-1	5-2	5-3	5-4	5-5	
208909	208910	208910	208965	209670-92	



工业缝纫机针位组

GAUGE SET FOR INDUSTRIAL SEWING MACHINES

INDUSTRIAL SEWING MACHINE SPARE PARTS

FOR PEGASUS/飞马

M752-17	M752-16S1 M752-16S2	M752-180	M752-53A M752-54A	M752-13	M752-23B
0x4	0x1.5	0x4	0x4	2x3 2x4	2.5x4.5
1-1 202546E	1-2 205465	1-3 202618A	1-4 205321	1-5 205255 20254E	1-6 209508-45
2-1 204676-BF	2-2 204730	2-3 204730A16F	2-4 204693	2-5 204676-BF	2-6 209417A25F
3-1 204675ABF 204674 208078-BF	3-2 204729A 208912 208911	3-3 204729B16F 204674 208090A16F	3-4 204692A 204677 208083	3-5 204675ABF 204674 208078-BF	3-6 209416-25F 204674 209509-25F
4-1 208525 201230C/201224B	4-2 208525 201230C/205525	4-3 208525 201473B/301433	4-4 208525 212182/210371	4-5 208525 208730/208731 208730/208732	4-6 208525 201230C/208050A
5-1 209670-92	5-2 208905	5-3 208906A92			



工业缝纫机针位组

GAUGE SET FOR INDUSTRIAL SEWING MACHINES

INDUSTRIAL SEWING MACHINE SPARE PARTS

FOR PEGASUS/飞马

M752-55A	M752-181	M732-36	M732-38	M732-70
2x4	2x4	3x3 3x4 3x5		5x5 5x6
1-1 202983	1-2 209732	1-3 204366 204367 204368		1-4 204360A 204361A
2-1 204693-BF	2-2 209742-16F	2-3 208218	2-4 208219	2-5 208215
3-1 204692ABF 204677 208083-BF	3-2 209741-16F 204677 209740-16F	3-3 204395 204425 208065	3-4 204396 208060 208066	3-5 204248B 208059 208063
4-1 208525 212182/201310A	4-2 208525 205253/209734	4-3 208501	4-4 208504	4-5 208502
5-1 208905	5-2 208905A92	5-3 208909B92	5-4 208910B92	



工业缝纫机针位组

GAUGE SET FOR INDUSTRIAL SEWING MACHINES

INDUSTRIAL SEWING MACHINE SPARE PARTS

FOR PEGASUS/飞马

M732-86	M732-48	M732-48P2	M732-354 M732-355	M852-16S2
5×5 5×6	3×4	3×4	3×2×4	0×1.5
1-1  204528 204529	1-2  204940	1-3  204940	1-4  208648	1-5  2054651
2-1  208217	2-2  204420	2-3  204420	2-4  208219	2-5  2047300
3-1  204394 208059 208064	3-2  204931 208061 208074	3-3  204931 208061 208074	3-4  204396 208060 208066	3-5  204729A0 2089120 2089110
4-1  208506 208955	4-2  208508	4-3  204502A	4-4  208649	4-5  274018-92B0 201230C0/2055250
5-1  208910B92	5-2  208909B92	5-3  208965B92	5-4  179630-920	



工业缝纫机针位组

GAUGE SET FOR INDUSTRIAL SEWING MACHINES

INDUSTRIAL SEWING MACHINE SPARE PARTS

FOR PEGASUS/飞马

M852-01	M852-17	M852-13	M832-38	M832-70
0×4	0×4	2×4 2×5	3×4	5×5
1-1  2057731	1-2  202546E1	1-3  202554E1 202498E1	1-4  2043671	1-5  204360A1
2-1  204730-BF0	2-2  204676-BF0	2-3  204676-BF0	2-4  2082190	2-5  2082150
3-1  204729ABF0 2046740 208090-BF0	3-2  204675ABF0 2046740 208078-BF0	3-3  204675ABF0 2046740 208078-BF0	3-4  2043960 2080600 2080660	3-5  204248B0 2080590 2080630
4-1  274018-92B0 201152E0/201155C0	4-2  274018-92B0 201230C0/2103710	4-3  274018-92B0 2087300/2087321	4-4  2771180	4-5  2771190
5-1  179630-920	5-2  277022-920	5-3  277027-921	5-4  277029-920	



工业缝纫机针位组

GAUGE SET FOR INDUSTRIAL SEWING MACHINES

INDUSTRIAL SEWING MACHINE SPARE PARTS

FOR PEGASUS/飞马

M832-86	EX5204-01/223K	EX5204-02/223K	EX5203-22/233K	EX5205-12/233K EX5203-12/233K
5x5	0x3 0x4	0x3 0x4 0x5	0x5 0x6	0x3 0x4
1-1  2045291	1-2  277500P30 277500P40	1-3  277504R30 277504R40 277504R50	1-4  277504R50 277504R60	1-5  277500P30 277500P40
2-1  2082170	2-2  277302-16F	2-3  277305-16F	2-4  277302-16F	
3-1  2043940 2080590 2080640	3-2  277301-16F 277318-13 277300-16F	3-3  277304-16F 277318-13 277303-16F	3-4  277304-16F 277318A13 277303A16F	3-5  277301-16F 277318-13 277300-16F
4-1  2771220	4-2  274018-92B 201230C/210370 201230C/210371 201230C/210374	4-3  274018-92B 202799/210371 202799/210372	4-4  274018-92B 201152E/277115 201152E/277103	
5-1  277029-920	5-2  179630-92			



工业缝纫机针位组

GAUGE SET FOR INDUSTRIAL SEWING MACHINES

INDUSTRIAL SEWING MACHINE SPARE PARTS

FOR PEGASUS/飞马

EX5204 -32R2/223(K)	EX5204 -32R2/223L (K)	EX5212-02/333K	EX5214-53/333K EX5214-53C3/333K	EX3216-02/223K
0x1.5	0x1.5	2x3 2x4 2x5	2x4 2x5	3x4 3x5
1-1  277512P15	1-2  277502P15	1-3  277505R30 277505R40 277505R50	1-4  277505R40 277505R50	1-5  277513R40 277513R50
2-1  277302-16F	2-2  277305-16F	2-3  277325-16		
3-1  277301-16F 277309-13 277315-16F	3-2  277304-16F 277318-13 277303-16F	3-3  277324-16 277318-13 277323-16		
4-1  274018-92B 202799/205525	4-2  274018-92B 201230C/210503 201230C/210374	4-3  274018-92B 277112/208651	4-4  277118	
5-1  179630-92	5-2  277022-92	5-3  277027-92		



工业缝纫机针位组

GAUGE SET FOR INDUSTRIAL SEWING MACHINES

INDUSTRIAL SEWING MACHINE SPARE PARTS

FOR PEGASUS/飞马

EX3216-03/233K	EX3216-03/233K	EX3215-04/435K EX3216	EX3244-03-333K	EXT5204-02/233K
3x4 3x5	5x5 5x6	5x5 5x6	3x2x4	0x4
1-1  277517R40 277517R50	1-2  277516R50 277516R60	1-3  277524T50 277524T60	1-4  277518R40	1-5  277504R400
2-1  277330-16	2-2  277329-16	2-3  277339-25	2-4  277329-16	2-5  277305-16F0
3-1  277328-16 277318-13 277327-16	3-2  277338-25 277318-13 277337-25	3-3  277328-16 277318-13 277327-16	3-4  277304-16F0 277318-130 277303-16F0	3-5  2773440
4-1  277118	4-2  277119	4-3  277122	4-4  277118A0	5-5  277149-400
5-1  277027-92	5-2  277028-92	5-3  277029-92	5-4  277030-92	6-1  179630-920



工业缝纫机针位组

GAUGE SET FOR INDUSTRIAL SEWING MACHINES

INDUSTRIAL SEWING MACHINE SPARE PARTS

FOR PEGASUS/飞马

EXT5214-43 /333K	EXT3215-02 /233K	W522-04B	W561 W562-01 CB/CC		
2x4	3x4	2x6.4	2x3.2 2x4.0 2x4.8	3x4.8	3x5.6 3x6.4
1-1  277505R400	1-2  277513R400	1-3  257180-64	1-4  257015B32 257015B40 257015B48	1-5  257016B48 257016B56	1-6  257018B56 257018B64
2-1  277305-16F0	2-2  277325-160	2-3  259246-16F	2-4  257258-16F	2-5  257259-16F	
3-1  277304-16F0 277318-130 277303-16F0	3-2  277324-160 277318-130 277323-160	3-3  259136-16F	3-4  257206-16F	3-5  257207-16F	
4-1  2773450	4-2  2773200	4-3  PE238	4-4  257460-32 257460-40 257460-48	4-5  257461-48 257461-56 257461-64	
5-1  277151-400	5-2  277153-400	5-3  257522-64	5-4  257517-32 257517-40 257517-48	5-5  257518-48 257518-56 257518-64	
6-1  277022-920	6-2  277027-920	7-1  252058-92			



工业缝纫机针位组
GAUGE SET FOR INDUSTRIAL SEWING MACHINES
INDUSTRIAL SEWING MACHINE SPARE PARTS

FOR PEGASUS/飞马

W562-01CA	W561-03 DB W562-03 DB	W562-03DC	W561 W562-02 BB/BC	
3×5.6	3×5.6 3×6.4	3×5.6	2×3.2	2×4.0 2×4.8
1-1  257018A56	1-2  257090B56 257090B64	1-3  257090C56	1-4  257029B32	1-5  257030B40 257030B48
2-1  257259-16F	2-2  257253-16F	2-3  257259-16F	2-4  257260-16F	2-5  257261-16F
3-1  257207-16F	3-2  257214-16F	3-3  257215-16F		
4-1  257461-56	4-2  257468-56 257468-64	4-3  257317A32	4-4  257318A40 257318A48	
5-1  257518-56	5-2  257518-56 257518-64	5-3  257518-56	5-4  257517-32	5-5  257517-40 257517-48



工业缝纫机针位组
GAUGE SET FOR INDUSTRIAL SEWING MACHINES
INDUSTRIAL SEWING MACHINE SPARE PARTS

FOR PEGASUS/飞马

W561 W562-02 BB/BC	W561-05BB	W562-05 BB		W561 W562-01 DB
3×5.6 3×6.4	3×4.8	2×3.2 2×4.0 2×4.8	3×5.6 3×6.4	4×6
1-1  257033B56 257033B64	1-2  257051B48	1-3  257049B32 257050B40 257050B48	1-4  257053B56 257053B64	1-5  257020-60
2-1  257262-16F	2-2  257267-16F	2-3  257266-16F 257267-16F 257267-16F	2-4  257268-16F	2-5  257256-16F
3-1  257216-16F	3-2  257221-16F	3-3  257220-16F 257221-16F 257221-16F	3-4  257222-16F	3-5  257203A16F
4-1  257321A56 257321A64	4-2  257330A48	4-3  257327A32 257328A40 257328A48	4-4  257331A56 257331A64	4-5  257491-60
5-1  257518-56 257518-64	5-2  257518-48	5-3  257517-32 257517-40 257517-48	5-4  257518-56 257518-64	5-5  257513-60

FOR PEGASUS/飞马

W664-01 CB		W664-03 FB		W664-02 BB	
2 x 3.2 2 x 4.0 2 x 4.8	3 x 5.6 3 x 6.4	3 x 5.6 3 x 6.4	3 x 5.6 3 x 6.4	2 x 3.2 2 x 4.0 2 x 4.8	3 x 5.6 3 x 6.4
1-1  257015B32 257015B40 257015B48	1-2  257018B56 257018B64	1-3  257097B56 257097B64	1-4  257029B32 257030B40 257030B48	1-5  257033B56 257033B64	
2-1  257289-16F	2-2  257290-16F	2-3  257291-16F 257292-16F 257292-16F	2-4  257293-16F		
3-1  257242-16F	3-2  257243-16F	3-3  257244-16F 257245-16F 257245-16F	3-4  257246-16F		
4-1  257460-32 257460-40 257460-48	4-2  257461-56 257461-64	4-3  257468-56 257468-64	4-4  257317A32 257318A40 257318A48	4-5  257321A56 257321A64	
5-1  257517-32 257517-40 257517-48	5-2  257518-56 257518-64	5-3  257518-56 257518-64	5-4  257517-32 257517-40 257517-48	5-5  257518-56 257518-64	

FOR PEGASUS/飞马

W664-34 AB		W664-35 BB		W1662-32B		737-504M2	
2 x 4.0 2 x 4.8	3 x 5.6 3 x 6.4	3 x 5.6 3 x 6.4	3 x 5.6 3 x 6.4	04(0 x 4)	04LFC--2(0 x 4)		
1-1  257100B40 257100B48	1-2  257102B56 257102B64	1-3  2Q0018B56D 2Q0018B64D	1-4  E800				
2-1  259202-16F	2-2  259203-16F	2-3  3G0007016F1	2-4  H445				
3-1  259100-16F	3-2  259101-16F	3-3  259110-16F	3-4  D440 D095 D575				
4-1  257485-40 257485-48	4-2  257486-56 257486-64	4-3  3Q00390356 3Q00390364	4-4  KS56 P253E/F371 P253E-3	4-5  KS56 P101/F371 P101-3			
5-1  257517-40 257517-48	5-2  257518-56 257518-64	5-3  257542-56 257542-64	5-4  KG131				

FOR SIRUBA/银箭

737-505F1	737-504M1	747-504M3	747-512M1	747-514M2	
03(0×3) 04(0×4)	15(0×4)	04(0×4)	24(2×4) 25(2×5)	24LF-B(2×4)	24TG-B(2×4)
1-1  E783 E784	1-2  E934	1-3  E919	1-4  E809 E810	1-5  E809	1-6  E805
2-1  H442		2-2  H445			
3-1  D438 D674 D569	3-2  D438 D912 D290	3-3  D440 D674 D574	3-4  D440 D095 D575	3-5  D440 D674 D574	
4-1  KS56 P152D/F155 P152D-3	4-2  KS56 P152D/F525 P152D-A	4-3  KS56 P253E/F374 P253E-4	4-4  KS56 P101/F374 P101-4	4-5  KS56 P254G/F504G P254G-4	
5-1  KG131		5-2  KG142			



FOR SIRUBA/银箭

757-516M2		757-516X2	767-516M2		
35(3×5)	55(5×5)	56(5×6)	324(3×2×4)	524(5×2×4)	
1-1  E982	1-2  E986	1-3  E868	1-4  E989	1-5  E988	
2-1  H497	2-2  H500	2-3  H501	2-4  H497	2-5  H500	
3-1  D489 D502 D581	3-2  D490 D502 D582	3-3  D971 D502	3-4  D972 D502		
4-1  P504	4-2  P502	4-3  P955	4-4  P233-A	4-5  P255-A	
5-1  KG153	5-2  KG155	5-3  KG333	5-4  KG356		



工业缝纫机针位组

GAUGE SET FOR INDUSTRIAL SEWING MACHINES

INDUSTRIAL SEWING MACHINE SPARE PARTS

FOR SIRUBA/银箭

737K-504M2	747K-514M2	757K-516M2	757K-516M2	767K-516M2
04(0X4)	24(2X4)	35(3X5)	55(5X5)	324(3X2X4)
1-1  E222	1-2  E229	1-3  E217	1-4  E218	1-5  E219
2-1  H204	2-2  H208	2-3  H209		
3-1  D207 D210		3-2  D207 D208		
4-1  P201-4A P201-A	4-2  P504J-A	4-3  P502J-A	4-4  P233J-A	
5-1  KG231K-E	5-2  KG242K-E	5-3  KG253K-E	5-4  KG255K-E	5-5  KG433K-E



工业缝纫机针位组

GAUGE SET FOR INDUSTRIAL SEWING MACHINES

INDUSTRIAL SEWING MACHINE SPARE PARTS

FOR SIRUBA/银箭

C007J-W522	C007E-U222/CQ	C007E-W122/CH		C007E-W222CQ	C007E-W152/CZ
3×5.6 3×6.4	3×5.6	2×4.0	3×5.6 3×6.4	2×4.0	3×5.6
1-1  E6426R E6427R	1-2  E4426P	1-3  E3524P	1-4  E3826P E3827P	1-5  E4124P	1-6  E4326P
2-1  D3222	2-2  H3362	2-3  H4258 H4259	2-4  H3362	2-5  H3262	
3-1  H3268	3-2  D3216	3-3  D4206 D4207	3-4  D3216		
4-1  P3816R-A P3817R-A	4-2  P2116	4-3  P0024	4-4  P0216 P0217	4-5  P1814	4-6  P2416
5-1  M5356 M5364	5-2  M4356	5-3  M4240	5-4  M4356 M4364	5-5  M4240	5-6  M4356



工业缝纫机针位组

GAUGE SET FOR INDUSTRIAL SEWING MACHINES

INDUSTRIAL SEWING MACHINE SPARE PARTS

FOR SIRUBA/银箭

C007E -W332/CD	C007E -W332/CE	C007J-W822	C007H-W122/CH C007H-W122CH/UTP(UTP)		C007-W152/ CZ/UTP/RL0
3×5.6	3×5.6	2×4.8 3×5.6 3×6.4	2×4.0 2×4.8	3×5.6 3×6.4	3×5.6
1-1  E3626P	1-2  E2626P	1-3  E0225R E0226R E0227R	1-4  E3524P E3525P	1-5  E3826P E3827P	1-6  E4326P
2-1  H4158	2-2  H3159	2-3  D2101	2-4  H4258	H4258 H4259	2-5  H3262
3-1  D4206	3-2  D2107	3-3  H2203R	3-4  D4206	D4206 D4207	3-5  D3216
4-1  P1406	4-2  P2765-A P2766-A P2767-A	4-3  P0024 P0025	4-4  P0216 P0217	4-5  P2416	
5-1  M4356	5-2  M5248 M5356 M5364	5-3  M5240 M5248	5-4  M5356 M5364	5-5  M5356	



工业缝纫机针位组

GAUGE SET FOR INDUSTRIAL SEWING MACHINES

INDUSTRIAL SEWING MACHINE SPARE PARTS

FOR SIRUBA/银箭

C007H-W162 C007H-U162	C007JD -W121/CH	C007H -W222/CQ	F007J-W222	F007H -W222/CQ
3×5.6 3×6.4	3×5.6 3×6.4	2×4.0 2×4.8	2×4.0 2×4.8	3×5.6 3×6.4
1-1  E3846 E3847	1-2  E3826 E3827	1-3  E4124P E4125P	1-4  E3024 E3025	1-5  E4426P E4427P
2-1  H4258 H4259	2-2  H4458 H4459	2-3  H3362	2-4  H1261	2-5  H3352 H3363
3-1  D4206 D4207	3-2  D3216	3-3  D1215	3-4  D3216 D3217	
4-1  P0226 P0227	4-2  P2446-A P2447-A	4-3  P1814 P1815	4-4  P2116-A P2117-A	
5-1  M5356 M5364	5-2  M5240 M5248	5-3  M5356 M5364		











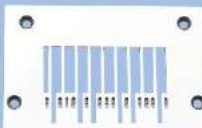





FOR SIRUBA/银箭

F007E -W122/UTG	F007E -W122/FQ	F007E -W222/FQ	F007E -W322/FDC	F007E -W922/FW
2×4.0 2×4.8	3×5.6 3×6.4	3×5.6 3×6.4	3×5.6	4×6.0
1-1	1-2	1-3	1-4	1-5
E1524 E1525	E1826 E1827	E3326 E3327	E4826	E1828
2-1	2-2	2-3	2-4	2-5
H1258	H1259	H1262	H1359	H1259
3-1	3-2	3-3	3-4	
D1206	D1207	D1216	D1207	
4-1	4-2	4-3	4-4	4-5
P0024 P0025	P0216 P0217	P2116-A P2117-A	P1406	P2408
5-1	5-2		5-3	5-4
M4240 M4248	M4356 M4364		M4356	M4460











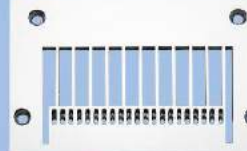





SIRUBA/银箭

VC008-04085P	VC008-06064P VC008-06048P	VC008-08064P
4×1	6×1/4 6×3/16	8×1/4
1-1	1-2	1-3
E9104D	E9112 E9012	E9108
2-1	2-2	2-3
D9104	D9112 D9012	D9108
3-1	3-2	3-3
P9104	P9512D-A P9412D-A	P9108-A
4-1	4-2	4-3
M9104	M9112 M9012	M9108
5-1	5-2	5-3
L9104	L9112 L9012	L9112
6-1	6-2	6-3
R9104	R9112 R9012	VUT109P

SIRUBA/银箭

VC008-12064P VC008-12048P	VC008-1332-032P	VC008-13064P
12x1/4 12x3/16	(1/4x1/8 x1/4)x3	13x1/8
1-1  E9112 E9012	1-2  E9113	1-3  E9313
2-1  D9112 D9012	2-2  D9113	2-3  D9313
3-1  P9112D-A P9012D-A	3-2  P9113D-A	3-3  P9313-A
4-1  M9112 M9012	4-2  M9113	4-3  M9313
5-1  L9112 L9012	5-2  L9119T-E	5-3  L9313
6-1  R9112 R9012	6-2  R9113	6-3  R9313

FOR SIRUBA/银箭

VC008-17	VC008-21	VC008-23
17x1/8.H (厚齿合针组)	21x1/8	23x1/8.H (厚齿合针组)
1-1  E9117A	1-2  E9121	1-3  E9123A
2-1  D9117A	2-2  D9121	2-3  D9123A
3-1  P9117-A	3-2  P9121-A	3-3  P9123-A
4-1  M9117	4-2  M9121	4-3  M9123
5-1  L9117	5-2  L9121	5-3  L9123
6-1  R9117	6-2  R9121	6-3  R9123



工业缝纫机针位组

GAUGE SET FOR INDUSTRIAL SEWING MACHINES

INDUSTRIAL SEWING MACHINE SPARE PARTS

FOR SUN STAR/日星

FOR YAMATO/大和

SC7300	SC7310	SF-7500/BN	AZ8000H	AZ8003H	
3 × 5.8 3 × 6.4	3 × 5.8 3 × 6.4	3 × 5.6 3 × 6.4	04(0 × 4)	03(0 × 3)	04(0 × 4)
1-1  GP-001320 GP-006766	1-2  GP-009973 GP-010244	1-3  GP-012184 GP-012185	1-4  2108000	1-5  2108002	1-6  2108003
2-1  GP-001357 GP-006770	2-2  GP-009972	2-3  GP-012180 GP-012186	2-4  2109000	2-5  2109007	2-6  2109005
3-1  GP-001356 GP-006769	3-2  GP-009971	3-3  GP-012179 GP-012985	3-4  2109001 2109067	3-5  2109006 2109067	
4-1  AS-000288 AS-001705	4-2  AS-002970 AS-003073	4-3  AS-003712 AS-003713	4-4  2107032	4-5  2107300	4-6  2107301
5-1  GP-001295 GP-006765			5-2  2109100		



工业缝纫机针位组

GAUGE SET FOR INDUSTRIAL SEWING MACHINES

INDUSTRIAL SEWING MACHINE SPARE PARTS

FOR YAMATO/大和

VF-2200	VF2300	VF2403			VF2500
132M (2 × 3.2) 140M (2 × 4.0) 148M (2 × 4.8)	156M (3 × 5.6)	140M (2 × 4.0)	148M (2 × 4.8)	140M-11 (2 × 4.0)	156M (3 × 5.6)
1-1  3108130 3108131 3108132	1-2  3108134	1-3  3208103	1-4  94283	1-5  95234	1-6  94801
2-1  3209001		2-2  3209065	2-3  3209005	2-4  3209009	2-5  3209001
3-1  3209080		3-2  3209064	3-3  3209004	3-4  3209008	3-5  3209000
4-1  63318 63319 63320	4-2  64041-N	4-3  3207151	4-4  94217	4-5  95238	4-6  95587
5-1  93351 93352 93353	5-2  93357	5-3  93352	5-4  3209102	5-5  3209101	5-6  3209107



工业缝纫机针位组
GAUGE SET FOR INDUSTRIAL SEWING MACHINES
INDUSTRIAL SEWING MACHINE SPARE PARTS

FOR YAMATO/大和

VF2503	VF2503-21	VC2600	VC2700	VC2700	
156M-11(3 × 5.6)	156M(3 × 5.6) 164M(3 × 6.4)	132M(2 × 3.2) 140M(2 × 4.0) 148M(2 × 4.8)	156L(3 × 5.6)	156M(3 × 5.6)	164M(3 × 6.4)
1-1	1-2	1-3	1-4	1-5	1-6
95085	3208108 3208109	93170 93171 93172	95493	94801	94802
2-1	2-2	2-3	2-4		
3209009	3209065	3109000	3109002		
3-1	3-2	3-3	3-4		
3209008	3209064	3109001	3109003		
4-1	4-2	4-3	4-4	4-5	
95089	3207156 3207157	63318 63319 63320	64041-N	64042-N	
5-1	5-2	5-3	5-4	5-5	5-6
3209107	3209107 3209108	93351 93352 93353	93358	93357	93358



工业缝纫机针位组
GAUGE SET FOR INDUSTRIAL SEWING MACHINES
INDUSTRIAL SEWING MACHINE SPARE PARTS

FOR YAMATO/大和

VC2603	VC2703	VG-2700		VG2700	
140M-11(2 × 4.0)	156M-11(3 × 5.6) 164M(3 × 6.4)	132M(2 × 3.2)	140M(2 × 4.0)	148M(3 × 4.8)	156M(3 × 5.6)
1-1	1-2	1-3	1-4	1-5	1-6
95234	95085 94802	3508000	3508001	3508002	3508003
2-1	2-2		2-4		
3109020 3109022	3509004		3509005		
3-1	3-2		3-4		
3109021	3509005		3509005		
4-1	4-2	4-3	4-4	4-5	4-6
95238	95089 94909	3507000-N	3507002-N	3507050-N	3507052-N
5-1	5-2	5-3	5-4	5-5	5-6
93352	93357 93358	93351	93352	93356	93357



工业缝纫机针位组

GAUGE SET FOR INDUSTRIAL SEWING MACHINES

INDUSTRIAL SEWING MACHINE SPARE PARTS

FOR YAMATO/大和

VG2700		VG2735		VG3711	VG-3721	
164M(3 x 6.4)		156M(3 x 5.6)	164M(3 x 6.4)	156M(3 x 5.6) 156M(3 x 6.4)	140S1(2x4.0)	148S1(3x4.8)
1-1	1-2	1-3	1-4	1-5	1-6	
3508004	3108002	3108003	3118025 3118026	3508098	3508099	
2-1	2-2	2-3	2-4	2-5		
3509004	3109024	3119020	3509039	3509036		
3-1	3-2	3-3	3-4			
3509005	3109025	3119021	3509037			
4-1	4-2	4-3	4-4	4-5	4-6	
3507064-N	3507108	3507111	3117124 3117126	3507060	3507064	
5-1	5-2	5-3	5-4	5-5	5-6	
93358	93357	93358	93357 93358	93352	93356	



工业缝纫机针位组

GAUGE SET FOR INDUSTRIAL SEWING MACHINES

INDUSTRIAL SEWING MACHINE SPARE PARTS

FOR YAMATO/大和

VG-3721		VE2713	VE2713	FD-62G	
156SI(3 x 5.6)	164SI(3 x 6.4)	156S-2-K4N (3 x 5.6)	156L-2-TIN 156L-TIN (3 x 5.6)	01MR (4 X 5.2) 01MS (4 X 6.0)	12MR (4X5.2) 12MS (4X6.0)
1-1	1-2	1-3	1-4	1-5	1-6
3508100	3508101	3158094	3158082	68491 68560	68491 68560
2-1	2-2	2-3	2-4	2-5	
3509036	3158034	3158019	3158034	68096	3029019
3-1	3-2	3-3			
3509037	3158037	68095			
4-1	4-2	4-3	4-4	4-5	
3507064	3107273 3107274	3507064	3507052-N	3027092 3027095	
5-1	5-2	5-3	5-4		
93357	93358	93357	68053 68553		



GAUGE SET

for industrial sewing machines
工业缝纫机针位组

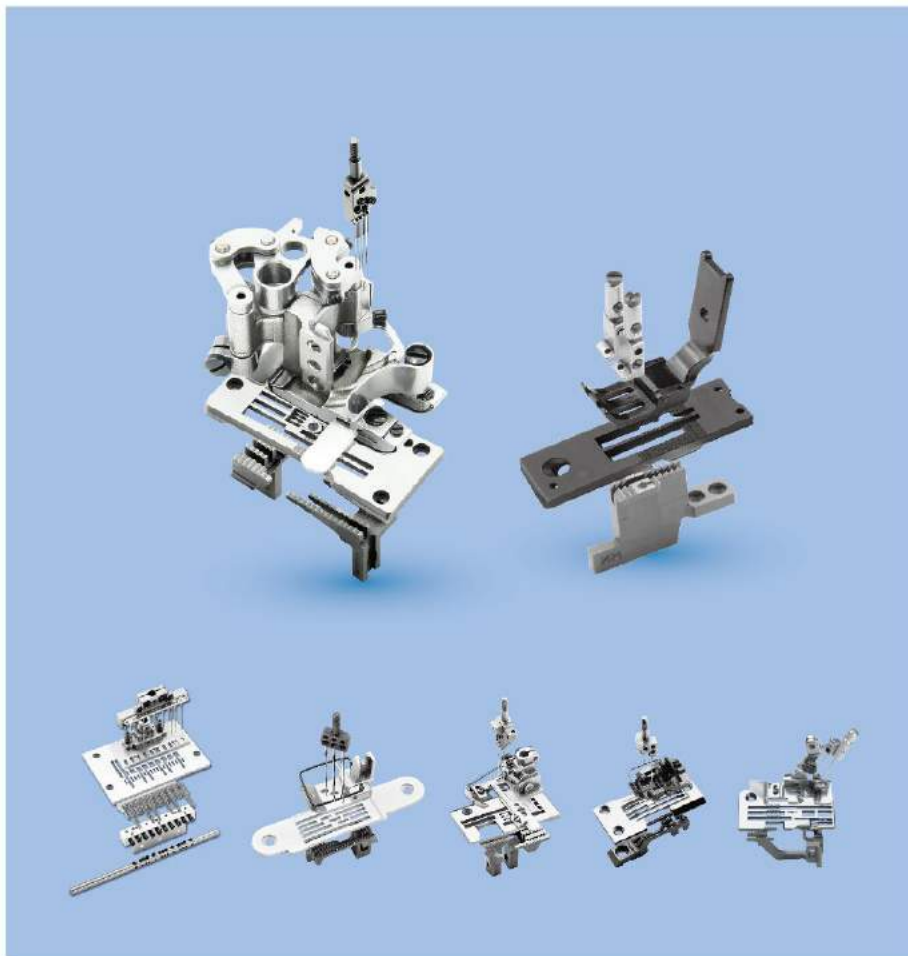

2015-2016 Catalogue

工业缝纫机针板 NEEDLE PLATE FOR INDUSTRIAL SEWING MACHINES

INDUSTRIAL SEWING MACHINE SPARE PARTS



FOR BROTHER/兄弟

1-1	1-2	1-3	1-4	1-5	1-6
S01711	TE503	S10570-001 SL-B777(1/8)	S10572-001 SL-B777(3/16)	S10573-001 SL-B777(1/4)	S10574-001 SL-B777(3/8)
146781-001 EF4-B531-022-5 (2.2'5)	146782-001 EF4-B531-023-6 (2.2'6)				
146783-001 EF4-B531-027-7 (2.2'7)					
S01711-001 EF4-B531-022-5 (2.2'5)					
S01713-001 EF4-B531-023-6 (2.2'6)					
2-1	2-2	2-3	2-4	2-5	
146783-001 B531/B551-027-7	146785-001 B531-031-7	146786-001 B531-033-5	S01711-001 B531-022-5 S01713-001 B531-022-6	146734-001 B511-002-5 146735-001 B511-002-6 146736-001 B511-002-7	
3-1	3-2	3-3	3-4	3-5	
S19156-001 EF4-N11-12-4	S25527-001 EF4-N21-22-4B S19189-001 EF4-N21-22-5B	146498-001 B551-061/062-3	146505-001 B551-065-6	146508-001 B551-069-5	
4-1	4-2	4-3	4-4	4-5	
146509-001 B551-071-6	S19182-001 MA4-N31-69-5	S08723-001 FD4-B272-011(3x5.6) S08724-001 FD4-B272-011(3x5.4)	S08724-001-G FD4-B272-011(3x6.4)	S08731-001 FD4-B272-021-7(3x5.6) S08732-001 FD4-B272-021-8(3x6.4)	



工业缝纫机针板

NEEDLE PLATE FOR INDUSTRIAL SEWING MACHINES

INDUSTRIAL SEWING MACHINE SPARE PARTS

FOR BROTHER/兄弟

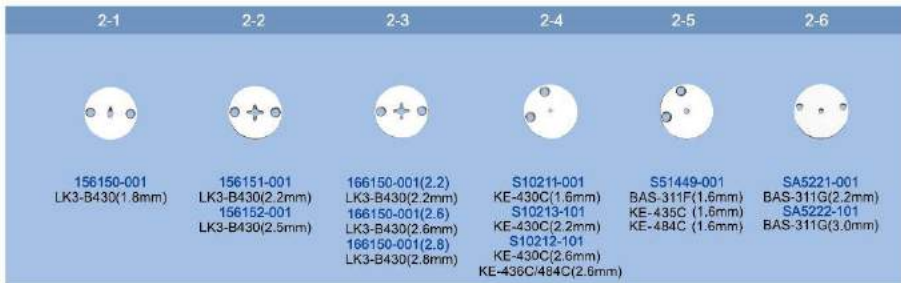

工业缝纫机针板

NEEDLE PLATE FOR INDUSTRIAL SEWING MACHINES

INDUSTRIAL SEWING MACHINE SPARE PARTS

FOR BROTHER/兄弟

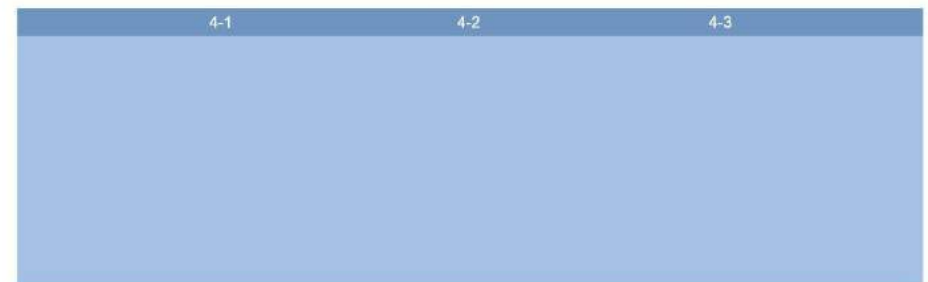
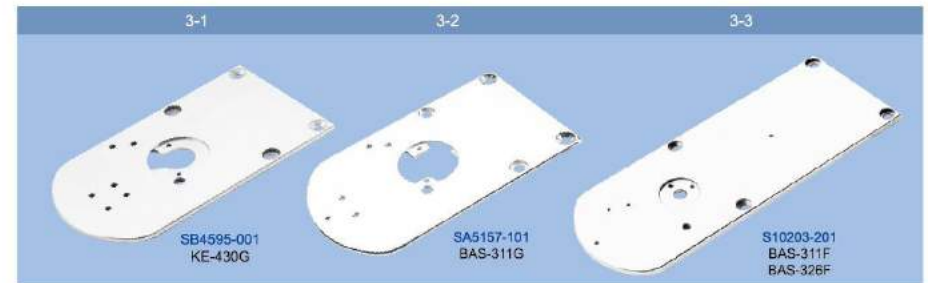



工业缝纫机针板

NEEDLE PLATE FOR INDUSTRIAL SEWING MACHINES

INDUSTRIAL SEWING MACHINE SPARE PARTS

FOR JUKI/重机

1-1	1-2	1-3	1-4	1-5	1-6
12485009	TE103	12485009	TE103	12485108	TE103
R4608-LOE-G0A R4508-LOE-G00 R4608-LOE-G00	MO-3316E-DE6-42H/S169 (3*3) MO-3316-DE4-40H MO-3316E-DE6-40H	R4612-LOH-G00 MO-3316-FH6-50H R4612-LOH-L00 MO-3316E (4.8*4.8)	R4612-LOH-G00 MO-3316-FH6-50H R4612-LOH-L00 MO-3316E (4.8*4.8)	R4612-L0F-L00 MO-3316-FF6-60H (4.8*4.8)	R4612-L0F-G00 MO-3316E (4.8*4.8)

2-1	2-2	2-3	2-4	2-5	
B1190-522-X00 B1190-522-Y00 B1190-522-7/32	DLM-5200(3/32) DLM-5200(5/32) DLM-5200(7/32)	B1190-522-S00 DLM-5200(1/8) B1190-522-T00 DLM-5200(3/16)	B1190-522-5/64 DLM-5200(5/64) B1190-522-U00 DLM-5200(1/4) B1190-522-V00 DLM-5200(3/8) B1190-522-Y08 DLM-5200(5/16)	B1190-530-D00 DMN-5420-7(1/8)	B1190-530-E00 DMN-5420-7(7/32)

3-1	3-2	3-3	3-4	3-5
B1190-530-F00 DMN-5420-7(3/16)	B1190-530-H00 DMN-5420-7(1/4)	B1190-530-M00 DMN-5420-7(3/8)	22581409S.A LZ-2280	22548010A LZ-2280

4-1	4-2	4-3	4-4												
APW-895		B1137-352-000 MO-352	B1137-354-000 MO-354												
	<table border="1"> <tr><td>400-46301</td><td>10mm</td></tr> <tr><td>400-46302</td><td>12mm</td></tr> <tr><td>400-46303</td><td>14mm</td></tr> <tr><td>400-46304</td><td>16mm</td></tr> <tr><td>400-46305</td><td>18mm</td></tr> <tr><td>400-46306</td><td>20mm</td></tr> </table>	400-46301	10mm	400-46302	12mm	400-46303	14mm	400-46304	16mm	400-46305	18mm	400-46306	20mm	B1136-357-A00 B1136-357-B00 B1136-357-C00	MO-357 MO-357 MO-357
400-46301	10mm														
400-46302	12mm														
400-46303	14mm														
400-46304	16mm														
400-46305	18mm														
400-46306	20mm														



工业缝纫机针板

NEEDLE PLATE FOR INDUSTRIAL SEWING MACHINES

INDUSTRIAL SEWING MACHINE SPARE PARTS

FOR JUKI/重机

1-1	1-2	1-3	1-4	1-5
R4200-EOD-C00 MO-804 R4200-EOD-D0A MO-1004 R4300-E0F-E00 MO-804-0F6	R4200-LOE-E02 MO-3300	R4300-LOE-E00 MO-3304E-OE6-40H	R4200-JOA-C00 MO-3704	R4300-JOE-E00 MO-3904

2-1	2-2	2-3	2-4	2-5
R4305-EOD-E00 MO-814 R4305-EOD-E0A MO-1014	R4305-HOF-E00 MO-2514	R4205-JOE-E00 MO-3914	R4305-JOD-E00(窄舌) MO-3914 R4305-JOE-E00(窄舌) MO-3615 R4305-JOF-E00 MO-3914	S4305-JOG-E00 MO-6700 R4305-J6D-E00 MO-6714

3-1	3-2	3-3	3-4	3-5
S4305-JOB-E00 MO-6700	R4308-J6F-E0B MO-6700	R4508-EOD-C00 MO-816	R4608-HOD-F00 MO-2516 R4608-HOF-G00 MO-2516	R4508-JOE-D00(窄舌) MO-3916

4-1	4-2	4-3	4-4	4-5
R4508-JOD-D00 MO-3916 R4508-JOF-D00 MO-3916	R4612-JOF-D00 MO-3916 R4612-JOF-F00 MO-3916 R4612-JOF-G00 MO-3916	R4612-JOF-D0A(窄舌) MO-3916 R4612-JOF-D0A MO-3916	R4608-JOF-D00 MO-3916 R4608-JOF-D0A MO-3916	R4508-J6E-D00 MO-6700 R4508-J6E-D0C MO-6700



工业缝纫机针板

NEEDLE PLATE FOR INDUSTRIAL SEWING MACHINES

INDUSTRIAL SEWING MACHINE SPARE PARTS

FOR JUKI/重机

1-1	1-2	1-3	1-4	1-5	1-6
R4612-J8F-K00 MO-6700/6500	B2402-761-000 LBH-761 B2402-762-000 LBH-762	B2402-771-000 LBH-780	B2402-772-K00 LBH-772	400-27553 LBH-1790 400-27554 LBH-1790	400-04350 400-04352 LBH-1790

2-1	2-2	2-3	2-4	2-5
R4253-FOH-G0P MF-8600(2x5.6)	R4354-FOH-G0B MF-8700(3x6.4)	B2529-373-000 MB-372/373	B2426-210-00A AMS-220C/210D(1.6mm) B2426-210-00B B2426-210-00C B2426-210-00F AMS-215C/220C/210D (2.0mm/2.4mm/3.0mm) B2426-210-00D AMS-210E	B2426-280-000 LK-1850(1.6mm) B2426-260-00B LK-1850(2.0mm) B2426-280-00C LK-1850(2.4mm)

3-1	3-2	3-3	3-4	3-5	3-6
D8-15-11 LK-1850(2.8mm)	D2426-282-C00 LK-1900(1.6mm) LK-1900(2.2mm)	B2426-280-B00 LK-1900A(2.0mm)	MAZ-15501000 LK-1903(1.6mm)	MAZ-15801000 LK-1903(1.6mm)	MAZ-15601000 LK-1903(2.0mm)

4-1	4-2	4-3	4-4
225-58407 LZ-2290	225-58308 LZ-2290	B1111038000 MH-481	B1109-027-AA0 LZ-391



工业缝纫机针板

NEEDLE PLATE FOR INDUSTRIAL SEWING MACHINES

INDUSTRIAL SEWING MACHINE SPARE PARTS

FOR JUKI/重机

1-1	1-2
B2425-210-000 AMS-205C AMS-206C AMS-210D	400-30934 AMS-210E AMS-221E AMS-224E

2-1	2-2
135-15564 LK-1850	135-15507 LK-1900

3-1	3-2
400-06721 LK-1900A	142-13003 LK-1910 LK-1920

4-1	4-2	4-3
B2401-781-0A0 LBH-760	B2401-771-0B0 LBH-780	400-04301 LBH-1790



工业缝纫机针板

NEEDLE PLATE FOR INDUSTRIAL SEWING MACHINES

INDUSTRIAL SEWING MACHINE SPARE PARTS

FOR JUKI/重机

1-1



B1241-373-000
MB-373

1-2



B1241-377-000
MB-377

FOR KANSAI SPECIAL/关西

2-1



14-318

2-2



14-319

2-3



TE048

2-4



14-3310

2-5



14-3320

2-6



14-3330

2-7



TE048

2-8



14-566
VT02-IS(2x6.4)

3-1



14-760
B2000C(2x6.4)
DVK-1702BK(2x6.4)

3-2



14-884 WX-D(2x3.2)
14-885 WX-D(2x4.0)
14-886 WX-D(2x4.8)

3-3

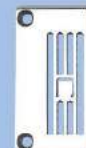

14-887
WX/RX-D(2x5.6)

3-4

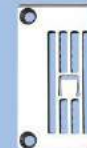

14-888
WX/RX-D(2x6.4)

3-5



14-567
BLX(2x6.4)

4-1

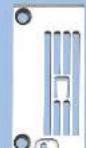

14-873 RX-P(2x4.0)
14-874 RX-P(2x4.8)

4-2



14-875
RX-P(3x5.6)

4-3



14-843 RX/C(2x4.8)
14-844 RX/C(2x5.6)
14-845 RX/C(2x6.4)

4-4



14-846
RX/C(3x5.6)
14-847
RX/C(3x6.4)

4-5



14-818
WX-8800(3x5.6)

工业缝纫机针板

NEEDLE PLATE FOR INDUSTRIAL SEWING MACHINES

INDUSTRIAL SEWING MACHINE SPARE PARTS



FOR KANSAI SPECIAL/关西

1-1



14-861
WX-8800(3x5.6)

1-2



14-889
RX,WX(3x4.8)

1-3



14-890H
RX,WX(3x5.6)

1-4



14-895

1-5



14-871
WX/DW(3x5.6)

2-1



14-896
RX/WX-CL(3x5.6)
14-897
RX/WX(3x6.4)

2-2



14-619
MZ-CL(3x5.6)

2-3



14-854B
W8103D(3x6.4)

2-4



14-854C
W8103D(3x5.6)

2-5



14-854D
W8103D(3x5.6)

3-1



14-859
W8103E(3x5.6)

3-2



14-875
RX-P(3x5.6)

3-3



14-876
RX-P(3x6.4)

3-4



14-892
WX/AH(3x6.4)

3-5



14-801
W8103C(3x5.6)
14-802
W8103C(3x6.4)

4-1



14-8780-1
WX-CLW(3x5.6)

4-2



14-8790-1
RX/CL(3x5.6)

4-3



14-881
VW-C(3x6.4)

4-4



14-882
VW-C(3x5.6)

4-5



14-883
VW-C(2x4.8)







工业缝纫机针板

NEEDLE PLATE FOR INDUSTRIAL SEWING MACHINES

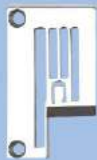

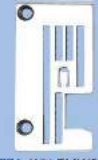

INDUSTRIAL SEWING MACHINE SPARE PARTS

FOR KANSAI SPECIAL/关西

1-1  14-186 NW/NR/F(2×3.2) 14-187 NW/NR/F(2×4.0)	1-2  14-188 NW-NR	1-3  14-728 DWK1802EMK(2×3.2) 14-748 DWK1802EMK(2×4.8) 14-758 DWK1802EMK(2×5.6) 14-768 DWK1802EMK(2×6.4)	1-4  14-771 WX-EMK(2×3.2) 14-772 WX-EMK(2×4.0) 14-773 WX-EMK(2×4.8) 14-774 WX-EMK(2×5.6) 14-775 WX-EMK(2×6.4)	1-5  14-784 WX-EMK(2×3.2) 14-785 WX-EMK(2×4.0)
--	---	--	--	--

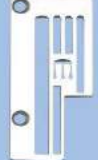
2-1  14-776 WX-EMK(3×5.6) 14-777 WX-EMK(3×6.4)	2-2  14-779 WX-EMK(3×4.8)	2-3  14-790 WX-EMK(3×5.6) 14-791 WX-EMK(3×6.4)	2-4  14-786 8013-1S(2×4.8)	2-5  14-857 WX-F(3×4.8)
--	---	--	--	---

3-1  14-175 WX/WF-F(2×4.8)	3-2  14-176 WX/UF-F(3×5.6) 14-177 WX/UF-F(3×6.4)	3-3  14-856B W803F(3×5.6)	3-4  14-866B W8103F(3×6.4)	3-5  14-192 NWNRF(3×5.6)
---	---	--	---	---

4-1  14-858 W8103EMK(3×5.6) 14-858 W8103EMK(3×6.4)	4-2  14-929 RX(3×5.6)	4-3  14-930 RX/PHK(3×6.4)	4-4  14-811 RX(2×4.0) 14-814 RX(2×4.8)	4-5  14-970 RX-XLK(3×4.8)
--	---	---	--	---





工业缝纫机针板

NEEDLE PLATE FOR INDUSTRIAL SEWING MACHINES



INDUSTRIAL SEWING MACHINE SPARE PARTS

FOR KANSAI SPECIAL/关西

1-1  14-812 RX(3×5.6) 14-813 RX(3×6.4)	1-2  14-3170-1 PX	1-3  14-183 MZ/UF-A(2×4.8)	1-4  14-611 MZ-A(2×4.0) 14-612 MZ-A(2×4.8)	1-5  14-184 MZ/UF-A(3×5.6) 14-185 MZ/UF-A(3×6.4)
--	---	--	--	--

2-1  14-613 MZ-A(3×5.6) 14-614 MZ-A(3×6.4)	2-2  14-615 MZ-C(3×4.0)	2-3  14-616 MZ-C/UF(2×4.8)	2-4  14-617 MZ-C/UF(3×5.6) 14-618 MZ-C/UF(3×6.4)	2-5  NE041 FX4408P
--	---	--	--	--

3-1  NE042	3-2  14-800 RX/J	3-3  14-150 HDX1101	3-4  14-151 HDX1101	3-5  LX-045 LX5802(2×8)
--	---	--	--	--

4-1  14-554 1503PTF(3×7.2)	4-2  14-581 DLR(1/4-1-1/4) 14-582 DLR(3/16-1-3/16) 14-583 DLR(1/4-3/4-1/4)	4-3  14-431 DFB1404PSFWB(1/4-1-1/4)
--	---	---



工业缝纫机针板

NEEDLE PLATE FOR INDUSTRIAL SEWING MACHINES

INDUSTRIAL SEWING MACHINE SPARE PARTS

FOR KINGTEX/宝狮

1-1	1-2	1-3	1-4	1-5
TP2120014 UH80B3021L04	TP6B3022 SH60B3	TP6B30221 SH60B3	5210TPB3022A	TP603032 SH6003

2-1	2-2	2-3	2-4	2-5
TP603053A SH6000	TP624A43 SH6024-A43-M14	TP604A32 SH6004-A32-M14	TP604A33 SH6004-A33-M14	TP604A42 SH6004-A42-M14

3-1	3-2	3-3	3-4	3-5
TP604A43 SH6004 TP604A53 SH6004	TP604B33 SH6004-B33-M14	TP604B53 SH6004-B53-H12	5210TP04A33 SH6004-A33-M14	5210TP04A43 SH6004-A43-M14

4-1	4-2	4-3	4-4	4-5
5210TP04A53 SH6004-A63-M14	5210TP04A63 SH6004-A63-M14	5212TP0015 UH8004-243-M14	TP645C53 SH6045-C53-M16	TP675C53 SH6075-C53-M16



工业缝纫机针板

NEEDLE PLATE FOR INDUSTRIAL SEWING MACHINES

INDUSTRIAL SEWING MACHINE SPARE PARTS

FOR KINGTEX/宝狮

1-1	1-2	1-3	1-4	1-5
5212TP0035 UH8005	5210TP05C52 SH6005-C52	TP605C53 SH6005 TP605D53 SH6005	TP845D53 SH6045-D53-M16	5210TP45D53

2-1	2-2	2-3	2-4	2-5
5212TP0033 SH6000	GTP605D53 SH6005 GTP605D63 SH6005	TP606CA3 SH6006	TP606DA3 SH6006-DA3-M43	TPC00561 FT6500(3x5.6) TPC00541 FT6500(3x6.4)

3-1	3-2	3-3	3-4	3-5
TPC13564 CT6513(3x5.6)	5220TP00568 CT6500-L(3x5.6) 5220TP00646 CT6500-L(3x6.4)	5222TP13562 CT9013-2(3x5.6)	5220TP00564 5220TP00566 FT7039-1-56M(3x5.6)	5222TP11400 FT7011-0-40M(2x4.0)

4-1	4-2	4-3	4-4	4-5
5222TP11480 FT7001-0-48M(3x4.8) 5222TP11580 FT7011-0-56M(3x5.6)	TPF60600 FT6760(4x6.0)	5221TP60600 FT6760	5222TP03400 KZ(3x4.0) 5222TP03480 KZ(3x4.8) 5220TP03580 KZ(3x5.6) 5222TP03640 KZ(3x6.4)	5220TP03563 CT4703(3x5.6) 5220TP85641 CT6585(3x6.4)



工业缝纫机针板

NEEDLE PLATE FOR INDUSTRIAL SEWING MACHINES

INDUSTRIAL SEWING MACHINE SPARE PARTS

FOR KINGTEX/宝狮

1-1



TPC42562
CT6642(3 x 5.6)

1-2



TPCL11561
CTL6511(3 x 5.6)

FOR PEGASUS/飞马

2-1



202554E-T TE238
205243
L52-51 (2*4)

2-2



TE238

2-3



204039B-2 TE070
204039B L32-31 (3*4)
204294B L32-31 (3*3)

2-4



TE070

2-5



204366-T TE070
204366 M752-38 (3*3)
204943 L32-80

2-6



TE070

2-7



204367-T TE070
204367 L32-38 (3*4)
204940 L32-48 (3*4)
204944 L32-78/79 (5*4)

2-8



TE070

3-1



204368 TE070
204360A L32-70 (5*5)
204368 L32-38 (3*5)
204945 L32-78 (5*5)
204528 L32-86 (5*6)

3-2



TE070

3-3



204529-2 TE070
204361A
L32-70 (5*6)

3-4



TE070

3-5



204529-T TE070
204529
L32-86 (5*6)

3-6



TE070

3-7



204939-02 TE070
204939
L32-48 (3*3)

3-8



TE070

4-1



204941
L32-48 (3*5)

4-2



TE070

4-3



210839-2 TE103
210839
E32-420/516-213 (3*5)

4-4



TE103

4-5



210840-2 TE103
210840
E32-420

4-6



TE103

4-7



210847-2 TE103
210847
E32-430/516-233 (3*5)

4-8



TE103

4-9



257020-60-2 TE318
257020-60
W562-01DB (4*6.0)

4-10



TE318

工业缝纫机针板

NEEDLE PLATE FOR INDUSTRIAL SEWING MACHINES

INDUSTRIAL SEWING MACHINE SPARE PARTS



FOR PEGASUS/飞马

1-1



200954 DCM-204
140135 DCM-204

1-2



202403
DCR-942

1-3



202618
L52-01

1-4



204731A
L52-17

1-5



210783 E52-211
210784 E52-211

2-1



210796 E52-130
210797 E52-130

2-2



210799 E52-130
210800 E52-130

2-3



213111-60
EX5104

2-4



202554E L52-13
202554E-H M752-13H
(2x4)

2-5



210804 E52-132
210805 E52-132

3-1



210806
E32
E52

3-2



210809 E52-131
210810 E52-131

3-3



277505R30 EX5212
277505R40 EX5214
277505R50 EX5214
277505R60 EX5214-03/333K

3-4



277502P15 EX5204-32R2
277512P15 EX5204-32R2

3-5



204943 L32-80
204944 L32-80
204945 L32-80

4-1



210837 E32-420
210838 E32-420
210839 E32-420
210840 E32-420

4-2



210845 E32-430
210846 E32-430
210847 E32-430
210848 E32-430

4-3



210868
E32-451

4-4



210980 E32-542
210981 E32-542
210982 E32-542

4-5



210987 E32-542
210986 E32-542



工业缝纫机针板

NEEDLE PLATE FOR INDUSTRIAL SEWING MACHINES

INDUSTRIAL SEWING MACHINE SPARE PARTS

FOR PEGASUS/飞马

1-1 210986 E32-542	1-2 277513R50-N EX3216	1-3 277519R40 EX3244-03	1-4 257111C48 W664-81AC(2 x 4.8)	1-5 259620B56 259620B5601 259620B6401 EX5204(3 x 5.6) WT2600(3x5.6) WT26002HENB (3x6.4)
------------------------------	----------------------------------	-----------------------------------	--	--

2-1 206276 W561-01(3 x 5.6) 257001B56 W562-01(3 x 5.6)	2-2 257082B56 W762L-01CB(3x5.6)	2-3 257018B56-N W664-01(3 x 5.6)	2-4 257018C56 W562-01CC(3x5.6) 257018C64 W562-01CC(3x6.4)	2-5 257018D56 W662-01(3 x 5.6)
--	---	--	---	--

3-1 257105B56 W664-03GB(3 x 5.6) 257105B64 W664-03GB(3 x 6.4)	3-2 257108B56 W664-08(3 x 5.6) 257108B64 W664-08(3 x 6.4)	3-3 236035B56 W603(3 x 5.6)	3-4 257023B32 W562-02SB(2x3.2) 257024B40 W562-02SB(2x4.0)	3-5 257028B32 257030B40 257030B48 257032B56 W562-02(2x3.2) W562-02(2x4.0) W562-02(2x4.8) W541-02BB(2x5.6)
---	---	---------------------------------------	---	---

4-1 206455 W562-02(3 x 5.6)	4-2 257031B56 W541-02BB(3 x 5.6) W542-02BB(3 x 5.6)	4-3 257033A56 W562-02CA(3 x 5.6) 257033A64 W562-02CA(3 x 6.4)	4-4 257033C56-18 W562-02(3 x 5.6)	4-5 257033C56-20 W562-02(3 x 5.6)
---------------------------------------	--	---	---	---



工业缝纫机针板

NEEDLE PLATE FOR INDUSTRIAL SEWING MACHINES

INDUSTRIAL SEWING MACHINE SPARE PARTS

FOR PEGASUS/飞马

1-1 257067B56 W756-202EB(3 x 5.6)	1-2 257102C56 W664-35C(3x5.6) W664-35AB(3x5.6) 257102C6400 W664-35AB(3x6.4)	1-3 2Q0018B56D0 W1662-32B(3 x 5.6) 2Q0018B64D0 W1662-32B(3 x 6.4)	1-4 259608B56 W562-01(3 x 5.6)	1-5 259614B56 WT-200(3 x 5.6)
---	--	---	--	---

FOR SIRUBA/银箭

2-1 E796 737-504M3-04 E797 737-504M3-05	2-2 E800C 737-504M2	2-3 E800D 737-504H4-04	2-4 E589F 737-504M5-04	2-5 E590 737E-504M2/BK
---	-------------------------------	----------------------------------	----------------------------------	----------------------------------

3-1 E591E 747-203BK	3-2 E591F 747F-514/BK	3-3 E591B 747-203BK	3-4 E804 E804A E805A 747-514M-23 747-512M8-23 747-512M8-24	3-5 E806A E919A 747-514M7-24 747-514M7-24
-------------------------------	---------------------------------	-------------------------------	--	---

4-1 E810A E920 E920A 747-512M8-25 747-512M1-25 747-512M8-25	4-2 E810L 747	4-3 E839 757-516L1-35	4-4 E870 757-56	4-5 E871 757FX-56
---	-------------------------	---------------------------------	---------------------------	-----------------------------



工业缝纫机针板

NEEDLE PLATE FOR INDUSTRIAL SEWING MACHINES

INDUSTRIAL SEWING MACHINE SPARE PARTS

FOR SIRUBA/银箭

1-1 E871C 757	1-2 E232 737-504M5-04-BK	1-3 E3525P C007F-W122(2×4.8)	1-4 E1836L F007E-U613(2×5.6) E1837L F007E-U613(2×6.4)	1-5 E2324P C007E-W542(2×4.0) E2325P C007E-W542(2×4.8)
-------------------------	------------------------------------	--	---	---

2-1 E1535 F007E-W123 F007E-UTG(2×4.8)	2-2 E2326P C007J-W132/CHE (3×5.6)	2-3 E4836M F007E/FDE(3×5.8)	2-4 E3524R C007E-U122/CH(2×4.0)	2-5 E8148P C007J-0092(2×4.8)
--	--	---------------------------------------	---	--

3-1 E8801 (2×4.8)	3-2 E8811(3×5.6) E8821(3×6.4)	3-3 E2625P C007E-U322/CF (2×4.8)	3-4 E1816(3×5.6) E1817(3×6.4) F007J-W121	3-5 E1826H (3×5.6) E1826H F007E-W121
-----------------------------	---	---	---	--

4-1 E1837 F007E-W123	4-2 E1846 F007E-W162(3×5.8) E1847 F007E-W162(3×6.4)	4-3 E3816P C007JD-W123(3×5.6) E3817P C007JD-W123(3×6.4)	4-4 E3826-H C007E-U512/FE-FFC (3×5.6)	4-5 E3836 C007JD-W121(3×5.6) E3837 C007JD-W121(3×6.4)
--------------------------------	---	---	--	---



工业缝纫机针板

NEEDLE PLATE FOR INDUSTRIAL SEWING MACHINES

INDUSTRIAL SEWING MACHINE SPARE PARTS

1-1 E3826R C007E-U122/CH(3×5.6) E3827R C007E-U122/CH(3×6.4)	1-2 E1623 F007F-V122/FP (2×3.2)	1-3 E2627P C007E/CE(3×6.4)	1-4 E2826P C007-U322/CC(3×5.6) E2827P C007-U322/CC(3×6.4)	1-5 E3827P C007E/CD(3×6.4)
---	--	--------------------------------------	---	--------------------------------------

2-1 E5827 U712,UT12/FSR (2×6.4)	2-2 E6828 WT22/FY(3×8.8)	2-3 E3727 F007J-W272/FSM (3×6.4)	2-4 E3326P F007E/FC(3×5.6) E3327P F007E/FQ(3×6.4)	2-5 E4326 C007D/CQ(3×5.6) E4327 C007D/CQ(3×6.4) E4327P C007E-W152/U152 (3×6.4)
--	------------------------------------	---	---	--

3-1 E6024 F007E-W522/FE (2×4.0)	3-2 E4426 C007E/CQ(3×5.6) E4427 C007E/CQ(3×6.4)	3-3 E6326 F007E-W522 FE(FFC)/FR(3×5.6) E6327 F007E-W522 FE(FFC)/FR(3×6.4)	3-4 E6426 C007E-W532/CRA/UTP CL/RCP/CX(3×5.6) E6426P	3-5 E6427P C007J-U532/CRA (3×6.4)
--	---	---	--	--

4-1 E0216R (2×4.8)	4-2 E0225Q C007J-W812A(2×4.8)	4-3 E0235 C007J-W813A(2×4.8)	4-4 E0216R(3×5.6) E0217R(3×6.4)	4-5 E0226P C007J-W812/CRL/RL (3×5.6)
------------------------------	---	--	---	---



工业缝纫机针板

NEEDLE PLATE FOR INDUSTRIAL SEWING MACHINES

INDUSTRIAL SEWING MACHINE SPARE PARTS

FOR SIRUBA/银箭

1-1 E0226Q C007J-W812A(3×5.6) E0227Q C007J-W812A(3×6.4)	1-2 E3966P (3×5.6)	1-3 E3967 (3×6.4)	1-4 E705Q L818F-RM(1/8) E705R L818F-RM(9/32) E705 L818F-RM(3/16) E705P L818F-RM(3/32)	1-5 E705T L818F-RM(3/8) E705S L818F-RM(1/4)
---	------------------------------	-----------------------------	---	---

2-1 E790	2-2 E791	2-3 E793	2-4 E794	2-5 E137 (2.2mm)
-----------------	-----------------	-----------------	-----------------	----------------------------

3-1 E137P (2.2mm)	3-2 E138 (2.6mm)	3-3 E139 (1.6mm)	3-4 E139P (1.6mm)	3-5 E140 (1.6mm)	3-6 E141 (2.0mm)
-----------------------------	----------------------------	----------------------------	-----------------------------	----------------------------	----------------------------

FOR YAMATO/大和

4-1 68490-1 68490 FD-62	4-2 TE472	4-3 34893 DCZ-200-D1 34894 DCZ-200-D1 36279 DCZ-703	4-4 32671 DCZ-203(2.5mm) 32672 DCZ-203(3.5mm) 32673 DCZ-203(4.5mm)	4-5 34566 DCZ-503-D3	4-6 37289 DC-12 37483 DCY-114
--------------------------------------	------------------	--	---	--------------------------------	---



工业缝纫机针板

NEEDLE PLATE FOR INDUSTRIAL SEWING MACHINES

INDUSTRIAL SEWING MACHINE SPARE PARTS

FOR YAMATO/大和

1-1 32666 DCY-114 32667 DCZ-200-D2	1-2 2108017 AZ-8016	1-3 2108008 AZ-8000H/AZ-8000H /AZ-8000G	1-4 2108100 AZ800H-5	1-5 21787 Z5020-Y6
--	-------------------------------	--	--------------------------------	------------------------------

2-1 33353(32678) DCZ-220W-D1	2-2 33353A(4mm) DCZ-220-D1 33353A(5mm) DCZ-220-D1	2-3 34598 DCZ-520-D1	2-4 36304 DZC-724Y	2-5 2108004 AZ8020H-Y5 2108005 AZ8020H-Y6
--	---	--------------------------------	------------------------------	---

3-1 6208000 CZ6000(2.4x5) 6208002 CZ6000(2.4x6)	3-2 2108006 AZ-6020H/AZ-6020H-4 /AZ-6020H/AZ-6000G	3-3 2158003	3-4 2158011	3-5 2108062 AZ8032H-Y5
---	---	--------------------	--------------------	----------------------------------

4-1 2108064 AZ8032H-Y7	4-2 27002 ZF-1500-X 27004 ZF-1500-X	4-3 2118009	4-4 33541 DCZ-361A-D2 DCZ-365A/DCZ-367A	4-5 33545 DCZ-361C
----------------------------------	---	--------------------	--	------------------------------



工业缝纫机针板

NEEDLE PLATE FOR INDUSTRIAL SEWING MACHINES

INDUSTRIAL SEWING MACHINE SPARE PARTS

FOR YAMATO/大和

1-1 35334 DCZ-341	1-2 2108050 AZ-8500-A4	1-3 2108052 AZ-8500-C5 2108076 AZ-8500H-C5	1-4 93410 DV1250-M(12x4.0) 93417 DV1266/VC2700/ VG2700-M(2x4.8)	1-5 94800 DW1350-MC(3 x 4.8)
-----------------------------	----------------------------------	--	--	--

2-1 90166 DW-100(3x5.6) 90167 DW-100(3x6.4) 94801-L-DC(5.6)DW-1350 (3x5.6)	2-2 3108133 VF2300-156M(3x8.4) 3108135 VC-2700(3x6.4)	2-3 3108134-H VF2300-156M(3x5.6) 3108134(厚舌) VC-2700(3 x 5.6)	2-4 3108134D VF-2300(3 x 5.6) 3108134.N VF2300-156M(3x5.6)	2-5 3108142-LN (3x5.6)
--	---	---	--	----------------------------------

3-1 94801-L2 VF-2500(3 x 5.6)	3-2 94801-L2-05 VF-2500(3 x 5.6)	3-3 94801-LC VF-2500(3 x 5.6)	3-4 94801C 94801C-L5 VF-2500(3 x 5.6)	3-5 94801D DW-1350(3 x 5.6) 94801D-L5 DW-1350(3 x 5.6)
---	--	---	--	--

4-1 94801-N VF-2500(3 x 5.6) 94801-N-2 VF-2500(3 x 5.6) 94801-N-5 VF-2500(3 x 5.6) 94801-FS VC-2613(3 x 5.6)	4-2 94801B VC2700C(3 x 5.6)	4-3 94802-L5 DW1350/DW1500/DW1700 (3 x 6.4)	4-4 3008021 VC-2700(3 x 5.6)	4-5 3508087 VG2713(P)-166M VG2713-156M
--	---------------------------------------	--	--	---



工业缝纫机针板

NEEDLE PLATE FOR INDUSTRIAL SEWING MACHINES

INDUSTRIAL SEWING MACHINE SPARE PARTS

FOR YAMATO/大和

1-1 3108141-N VF-2300(3 x 5.6) 3108140-NS	1-2 3508008 VC2700(3 x 5.6)	1-3 3158006 VE-2713-156L(3 x 5.6)	1-4 3158012 VE-2713-156S(3 x 5.6)	1-5 3108136 (4x6.0)
--	---------------------------------------	---	---	-------------------------------

2-1 94281 VF-2403(2 x 3.2)	2-2 94210 DV-1253MA(2 x 3.2) 94211 DV-1253MA(2 x 4.0) 94212 DV-1253MA(2 x 4.8)	2-3 95260 DV-1409(2 x 3.2)	2-4 95261 DV-1409(2 x 4.0) 95262 DV-1409(2 x 4.8)	2-5 3208097 VF-2539(2 x 3.2) 3208096 VF-2539(2 x 4.0)
--------------------------------------	---	--------------------------------------	---	---

3-1 90556 DW-303(3 x 6.4) 90557 DW-303(3 x 6.4)	3-2 91764 DW-103(3 x 5.6) 91765 DW-103(3 x 6.4) 94901 DW-1353(3 x 5.6)	3-3 3268014 VFS-2511(3 x 6.4)	3-4 3008025 VF-2503-11(3 x 6.4)	3-5 3208026 VF-2503(3 x 4.8)
---	---	---	---	--

4-1 3208093 VF-2539(3 x 5.6) 3208094 VF-2539(3 x 6.4)	4-2 3118023 VC-3711(2 x 5.6)	4-3 95278 DW-1509(3 x 5.6) 95279 DW-1509(3 x 6.4)	4-4 6508023 VT1500(3 x 5.6)	4-5 68491	4-6 004182
---	--	---	---------------------------------------	------------------	-------------------



工业缝纫机针板

NEEDLE PLATE FOR INDUSTRIAL SEWING MACHINES

INDUSTRIAL SEWING MACHINE SPARE PARTS

FOR MITSUBISHI/三菱

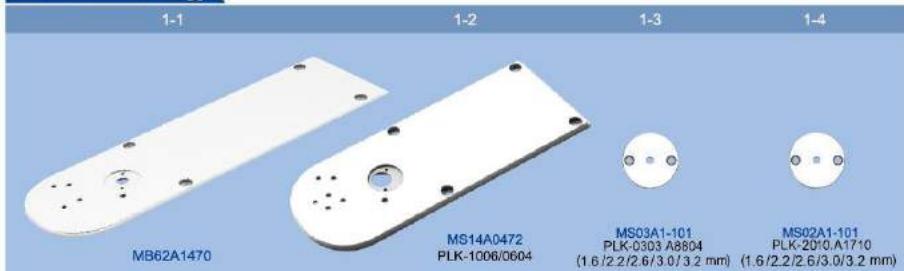

FOR SHING LING/星菱



FOR SHING RAY/星锐



FOR SINGER/胜家

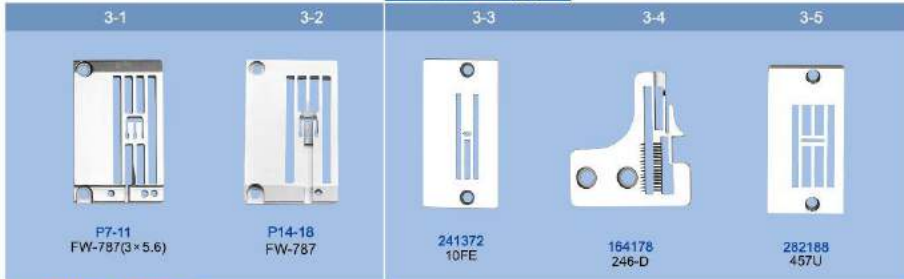

FOR SUN STAR/日星

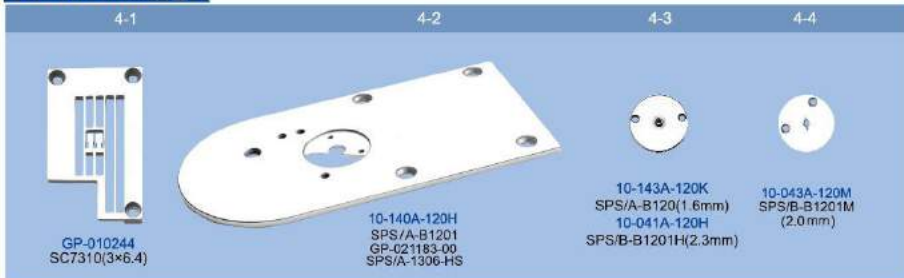

工业缝纫机针板

NEEDLE PLATE FOR INDUSTRIAL SEWING MACHINES

INDUSTRIAL SEWING MACHINE SPARE PARTS

FOR SUN STAR/日星



FOR UNION SPECIAL/友联



FOR PFAFF/百福



FOR HIGHLEAD/海菱

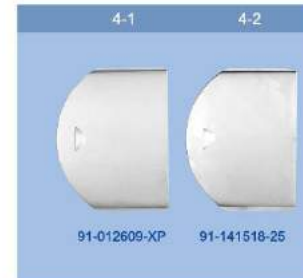

FOR OTHERS/其他





工业缝纫机牙齿

FEED DOG FOR INDUSTRIAL SEWING MACHINES

INDUSTRIAL SEWING MACHINE SPARE PARTS

FOR BROTHER/兄弟



FOR JUKI/重机



FOR KANSAI SPECIAL/关西



工业缝纫机牙齿

FEED DOG FOR INDUSTRIAL SEWING MACHINES

INDUSTRIAL SEWING MACHINE SPARE PARTS

FOR KANSAI SPECIAL/关西



FOR SHING RAY/星锐



FOR PEGASUS/飞马



FOR SIRUBA/银箭



FOR SUN STAR/日星



FOR YAMATO/大和





工业缝纫机牙齿

FEED DOG FOR INDUSTRIAL SEWING MACHINES

INDUSTRIAL SEWING MACHINE SPARE PARTS

FOR YAMATO/大和



工业缝纫机压脚

PRESSER FOOT FOR INDUSTRIAL SEWING MACHINES

INDUSTRIAL SEWING MACHINE SPARE PARTS

FOR BROTHER/兄弟



FOR KANSAI SPECIAL/关西





工业缝纫机压脚

PRESSER FOOT FOR INDUSTRIAL SEWING MACHINES

INDUSTRIAL SEWING MACHINE SPARE PARTS

FOR JUKI/重机

1-1 1-2 1-3 1-4 1-5



B1525-241-HA0
DNU-241H



118-76067
MO-2504-OA4-150
(0x1.6)
MO-2504-OA4-150-FG
(0x1.6)



118-81471
MO-2504-OD4-200
(0x3.2)



118-76364
MO-2504-OD6-300
(0x3.2)



118-77156
MO-2512-DD6-500 (3.2x3.2)
MO-2512-DD6-600 (3.2x4.8)

2-1 2-2 2-3 2-4 2-5



118-77164
MO-2512-DD6-500 (3.2x3.2)
MO-2512-DD6-600 (3.2x4.8)



118-79269
MO-2514-BO6-340
(2x3.2)



118-81570
MO-2514-BD4-200
MO-2514-BD4-200-FG
(2x3.2)



118-77578
MO-2516-DD4-300
(3.2x3.2)
MO-2516-DF4-300
(3.2x4.8)



118-77768
MO-2516-FF6-500
(4.8x4.8)

3-1 3-2 3-3 3-4 3-5



118-78063
MO-2543-FBD6-300
(4.8x2.0x3.2)
MO-6743-ID6-40H
(4.8x2x3.2)



121-52451
MO-3914-BE5



121-52955
MO-3916-BE
(2x3.2)



121-52963
MO-3916-BE
(2x3.2)



12467205
MO-3700

4-1 4-2 4-3 4-4



135-18600



135-18709



135-54308



135-54407



135-72003



135-71906



135-48201



135-48102

135-18659
LK-1850(20x4.5)

135-54357
LK1850G(20x8.1)

135-71955
LK1900 (27x5)
LK1900A

135-48151
LK1900 (27x5)
LK1900A (27x5)

工业缝纫机压脚

PRESSER FOOT FOR INDUSTRIAL SEWING MACHINES

INDUSTRIAL SEWING MACHINE SPARE PARTS



FOR JUKI/重机

1-1 1-2



141-16107
LK1900B



135-54803
LK1900A

2-1 2-2 2-3 2-4 2-5



D1511-771-KA0-A
LBH-781



D1511-772-KA0-A
LBH-782



D1511-771-KA0
LBH-782-K



D1511-773-KA0-A
LBH-783



400-08646
LBH-1790

3-1 3-2 3-3 3-4 3-5



TE424
B1552-781-000A
LBH-781



TE424
B1552-782-000
LBH-782



TE424
D1508-772-K00
LBH-782-K



TE424
B1552-783-000
LBH-783



TE424
400-08658
LBH-1790

4-1 4-2 4-3 4-4 4-5



B1552-781-0A0-A
LBH-781(16mm)



B1552-782-0A0-A
LBH-782(25mm)



B1552-782-0A0-A(K)
LBH-782-K(25mm)



B1552-783-0A0-A
LBH-783 (30mm)



PE040
LBH-1790



工业缝纫机压脚

PRESSER FOOT FOR INDUSTRIAL SEWING MACHINES

INDUSTRIAL SEWING MACHINE SPARE PARTS

FOR PEGASUS/飞马

1-1



208506S
L32-86(5x6)

1-2



257350-32
W562-02HB(2x3.2)

1-3



257499-3200
W562-02DB(2x3.2)

FOR SIRUBA/银箭

2-1



P201-4A
S700K

2-2



P211-A
S700K

2-3



P203-A
737K

2-4

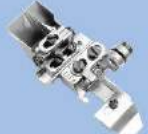

P212A-A
737KLF-D6

2-5



P103/F371
P103-3
737-504M2(0x4)

KS56

3-1



P253E/F525
P253E-5
747F-512M1(0x3)

KS56

3-2



P217-4
S700K

3-3



P975/F380
P975-3
M737-514M5(2x4)

KS56

3-4



P103/F374
P103-4
747-514M2(2x4)

KS56

3-5



P975/F381
P975-4
M747-514M5(2x4)

KS56

4-1



P1813-A
F007

4-2



P2314-A
F7J-U222-24

4-3



P0314-A
C700E-U122

4-4



P212A-5A
737KLF

4-5



P3816R-A
P3817-A
C007J-W522
(3x5.6)(3x6.4)



工业缝纫机压脚

PRESSER FOOT FOR INDUSTRIAL SEWING MACHINES

INDUSTRIAL SEWING MACHINE SPARE PARTS

FOR SIRUBA/银箭

1-1



P2315-A
F007J

1-2



P2436-A
F007/C007K(3x5.6)

1-3



P24380-A
F007(4x6)

1-4



P2457-A
C007JD-W322/CC
(3x6.4)

1-5



P0416-A
C007E-U122/CH/UTQ
(2x5.6)(3x6.4)

1-6



P2544-A
F007

2-1



P2545-A
F007

2-2



P5232K-A
F007

2-3



P8003-A
HF008

2-4



P8104-A

FOR YAMAYO/大和

2-5



2157086
AZ8000H(0x4)
AZ8000G(0x4)

3-1



2107290/2107240
AZ8020H-Y5

3-2



2107308
2107309
AZ8020H-Y5(2.4x5)
AZ8020H-Y6(2.4x6)

3-3



2157057
2157058
AZ8020G(2.4x5)/(2.4x6)
AZ6020H(2.4x5)/(2.4x6)

3-4



2157116
2157118
AZ8020G(2.4x5)/(2.4x6)
AZ6020H(2.4x5)/(2.4x6)

3-5



2107100
AZ8500H-A4(3.2x4)

3-6



2107102
AZ8500H-C5(5x5)

4-1



2157310
AZ8500G-A4(3.2x4)
AZ6500H-A4(3.2x4)

4-2



2157315
AZ8500G-C5(5x5)
AZ6500H-C5(5x5)

4-3



26135
ZF-125

4-4



37496
DCY104
DCY114

4-5



95580
95581
95582
VF2400-132M(2x3.2)
VF2400-140M(2x4.0)
VF2400-148M(2x4.8)

4-6



6507003
VT1500(3x5)



工业缝纫机针镙

NEEDLE CLAMP FOR INDUSTRIAL SEWING MACHINES

INDUSTRIAL SEWING MACHINE SPARE PARTS

FOR BROTHER/兄弟

1-1 1-2 1-3 1-4 1-5 1-6



146487-001 MA4-B551-061(2x3) MA4-B551-062(2x3)	S02404-001 MA4-N31-63-3(3x3) MA4-N31-63-4(3x4) MA4-N31-63-5(3x5)	181722-001 DT6-B928-6(2x3/16) DT6-B928-8(2x3/16)	S06709-001 FD4-B272-011-6(3x4.8) FD4-B272-021-6(3x4.8)	S08711-001 FD4-B272-011-7(3x5.6) FD4-B272-021-7(3x5.6)	S08713-001 FD4-B272-011-8(3x6.4) FD4-B272-021-8(3x6.4)
--	---	--	--	--	--

FOR JUKI/重机

2-1 2-2 2-3 2-4 2-5



APW895

400-46314	10mm
400-46315	12mm
400-46316	14mm
400-46317	16mm
400-46318	18mm
400-46319	20mm



118-69955
MO-2512(3.2x3.2)



B1420-716-D00
MO-816



B1409-890-GA0
MF-890-GEM
(3x5.6)



B1409-890-HA0
MF-890HBM(3x6.4)
MF-890HEM(3x6.4)

FOR KINGTEX/宝狮

3-1 3-2



NC603033
SH6002-032-M02
SH6003-032-M04
SH6043-033-M04

NC604022
SH6004-A32-M14
SH6004-A42-M14
SH6004-A33-M14

FOR SHING LING/星菱

3-3 3-4



FC240
FC248
FW777
(2x4.0)(2x4.8)

FC356
FC364
FW777
(3x5.6)(3x6.4)

FOR SHING RAY/星锐

3-5



P7-7(5.6)
FW787(3x5.6)

FOR KANSAI SPECIAL/关西

4-1 4-2 4-3 4-4 4-5



12-2200-1
DVX1702(2x6.4)

12-8290-1
WX/DW(3x6.4)
WX8800(2x5.6)

12-8010-1
V7003D-7/32*(3x5.6)
V8003C-7/32*(3x5.6)
V7003F-7/32*(3x5.6)

12-8020-1
V7003D-1/4*(3x5.6)
V8003C-1/4*(3x5.6)
V7003DE-1/4*(3x5.6)

12-8120-1
V7002D(2x4)

工业缝纫机针镙

NEEDLE CLAMP FOR INDUSTRIAL SEWING MACHINES

INDUSTRIAL SEWING MACHINE SPARE PARTS



FOR PEGASUS/飞马

1-1 1-2 1-3 1-4 1-5 1-6 1-7



209670
M752-180
(0x4)

208914
L32

277031-92
EX3244-03/333K
(5x2x4)

257500-40
257500-48
W500(2x4.0)
W600(2x4.8)

257501-56
257501-64
W500(3x5.6)
W600(3x6.4)

257542-561
257542-641
W1612-32B(3x5.6)
W1612-32B(3x6.4)

236631-56
FW603AF
(3x5.6)

FOR PFAFF/百福

2-1 2-2 2-3 2-4 2-5 2-6



91-164726-93/003

91-164727-X4

91-710004-04/002

91-710004-04

91-710004-04/005

91-710004-04/006

FOR SIRUBA/银箭

3-1 3-2 3-3 3-4 3-5



M4232
F007-U22/FP
(2x3.2)

M5232
F007-U22/FP
(2x3.2)

M4348
C007-U322/CF
(3x4.8)

M5348
C007-U322/CF
(3x4.8)

KG231K-E
737K-504M1
737K-504M2
(0x3)(0x4)

4-1 4-2 4-3 4-4 4-5



KG242K-E
747K-512M1
747K-514M2
(2x4)

KG253K-E
757K(5x5)(5x6)

KG255K-E
757K-516M2(5x5)

KG433K-E
767K-516M2
(3x2x4)

KG456K-E
767K-516M2
(3x2x4)



工业缝纫机针钳

NEEDLE CLAMP FOR INDUSTRIAL SEWING MACHINES

INDUSTRIAL SEWING MACHINE SPARE PARTS

FOR SUN STAR/日星

1-1	1-2	1-3	1-4	1-5
				
GP-031183-00 SC7300H-156M (3x5.6)	GP-068802-00 SC7200-148M(3x4.8) SC7210-148L(3x4.8)	GP-013516 SC7300(3x4.8)	GP-032603 SC7200H(2x3.2) GP-032604 SC7200H(2x4.0) GP-032605 SC7200H(2x4.8) GP-032606 SC7300H(3x6.4)	GP-030272

FOR YAMATO/大和

2-1	2-2	2-3	2-4	2-5
				
2109101 AZ8020H-Y5(2.4x5) AZ8020H-Y56(2.4x8)	2109102 AZ8020H-X4 (2x4)	2109110 AZ8500H-A4 (3.2x4)	3109111 3109112 VC2700(3x5.6) VC2700(3x6.4)	3209100 VF2400-132M (2x3.2)

3-1	3-2	3-3	3-4	3-5
				
3209106 VF2500-148M (3x4.8)	2109112 AZ8500H-C5(5x5)	2109132 AZ6003H-03(0x3) AZ6000H-03(0x3) AZ6016H-02	2109120 AZ6500H-A4(3.2x4) AZ6500H-A5(3.2x5)	2109122 AZ6500H-C5(5x5) AZ6500H-C6(5x6)

4-1	4-2	4-3	4-4	4-5	4-6
					
2159102 AZ8020H (2.4x5)(2.4x6) AZ8020G (2.4x5)(2.4x6)	2159111 AZ8500H-A4(3.2x4) AZ8500G-A4(3.2x4)	2159112 AZ8500H AZ8500G (5x5)	2169113 AZ7800G	93251 93252 93253 DV1250-MA(2x3.2) DV1250-MB(2x4.0) DV1250-MC(2x4.8)	93257 DW1350-MD(3x5.6)

索引表

PARTS LIST

INDUSTRIAL SEWING MACHINE SPARE PARTS



品号 PART NO.	页数 PAGE	行数 LINE	品号 PART NO.	页数 PAGE	行数 LINE	品号 PART NO.	页数 PAGE	行数 LINE	品号 PART NO.	页数 PAGE	行数 LINE
0			0580 330120	P38	4-1	1-121-117	P32	3-6	102-11118	P15	2-8
004182	P210	4-6	0580 330130	P38	4-1	1-8(5mm)	P34	2-7	102-11209	P15	2-7
004539.00	P34	1-1	0580 330140	P38	4-1	1-8A(3mm)	P34	2-5	102-32403	P15	2-6
004540.00	P34	1-2	0580 330150	P38	4-1	10-001A-120H	P27	2-6	10211605	P15	3-3
018260-832	P100	2-1	0580 330380	P38	3-1	10-001A-2700	P27	1-6	103-002	P35	1-3
021020-106	P100	2-1	0580 330390	P38	2-6	10-001A-64L7	P27	2-2	103-019	P35	1-2
025030-236	P97	1-1	06-351	P17	1-3	10-002A-7507	P27	2-4	103986	P51	1-3
025030-236	P97	1-1	06-632	P17	1-4	10-002A-8677	P27	3-4	1039885	P32	4-6
025030-236	P98	1-1	060630312	P100	1-1	10-005A-2700	P27	1-7	1039896	P32	4-3
025030-236	P98	1-1	061300-416	P100	2-1	10-006A-120H	P27	2-5	1039999	P33	1-4
025030236	P98	2-1	062020-416	P100	2-1	10-006A-235B	P27	1-5	104336003	P100	1-1
025030236	P98	2-1	062300416	P97	1-1	10-007A-7507	P27	2-3	10502300	P12	1-5
025030236	P99	1-1	062300416	P97	1-1	10-008A-64L7	P27	2-1	105306-101	P6	2-1
025030236	P99	1-1	062300416	P98	1-1	10-011A-8677	P27	3-3	105935	P51	1-4
025030236	P99	2-1	062300416	P98	1-1	10-0250-0	P153	3-1	105935-B	P51	1-4
025030236	P99	2-1	062300416	P98	2-1	10-0300-0	P154	3-1	106629002	P101	1-1
025040132	P101	1-1	062300416	P98	2-1	10-041A-120H	P211	4-3	107-26305	P15	1-6
0252052-141-C	P28	4-5	062300416	P99	1-1	10-043A-120M	P211	4-4	107-26404	P15	1-7
0252072-145-B	P28	4-4	062300416	P99	1-1	10-051W-120H	P109	2-1	108065-S	P51	1-2
026300-512	P100	2-1	062300416	P99	2-1	10-052W-120H	P109	2-1	109148	P51	1-1
0271001483	P7	3-1	062300416	P99	2-1	10-054W-120H	P109	2-1	10E	P59	1-1
0271001497	P7	3-2	062670712	P96	1-1	10-101A-2700	P27	1-4	10E(TFL)	P59	3-1
028030-246	P97	1-1	0667 355110	P8	1-5	10-1069-0-001	P39	4-2	10EW	P60	1-1
028030-246	P98	1-1	0667 355130	P8	1-6	10-1069-0-002	P39	4-2	10EW(K0)	P60	1-1
028030246	P98	2-1	0667 355140	P8	1-7	10-1069-0-003	P39	4-2	10KM	P59	2-1
028030246	P98	2-1	07-124	P16	3-6	10-1069-0-004	P39	4-2	10KMW	P60	2-1
028030246	P99	1-1	07-125	P16	1-1	10-1069-0-005	P39	4-2	10RAS261	P29	4-7
028030246	P99	1-1	07-168	P16	3-8	10-1069-0-006	P39	4-2	10S040S-306H	P109	2-1
028030246	P99	2-1	07-169	P16	1-2	10-1069-0-007	P39	4-2	10S042S-306H	P109	2-1
0281 170210	P7	3-5	07-170	P16	3-5	10-1069-0-051	P39	3-1	10S045S-306H	P109	2-1
0281 350300	P7	3-3	07-206	P16	1-3	10-1069-0-052	P39	3-1	10S045S-306H	P27	2-8
0281 350310	P7	3-4	07-406	P16	3-7	10-1069-0-054	P39	3-1	10S046S-306H	P109	2-1
03-012	P34	2-2	07-432	P16	1-4	10-1069-0-055	P39	3-1	10S047S-306H	P109	2-1
030-0095-00	P6	2-2	07-505	P16	3-4	10-1069-0-056	P39	3-1	10S047S-306H	P27	2-7
030-0095-00.SH	P6	2-4	07-507	P16	1-5	10-1069-0-060	P39	3-1	10S048S-306H	P109	2-1
030-0096-00	P6	2-3	07-522	P16	1-6	10-106A-2700	P27	1-3	10S050S-306H	P109	2-1
030-0096-00.SH	P6	2-5	07-529	P16	1-7	10-1197-1	P28	2-6	10S053S-306H	P109	2-1
030-0097-00	P6	2-6	07-544	P16	4-2	10-140A-120H	P211	4-2	10S056S-306H	P109	2-1
030-0097-00.SH	P6	3-1	07-545	P16	4-3	10-143A-120K	P211	4-3	10S057S-306H	P109	2-1
030-0098-00	P6	2-7	07-558	P16	2-1	10-3072-0-014	P39	2-1	10S058S-306H	P109	2-1
030-0098-00.SH	P6	3-2	07-570	P16	4-1	10-3072-0-014/M	P39	2-2	10S059S-306H	P109	2-1
030-0461-00	P6	3-5	07-596	P16	2-2	10-3072-0-024	P39	1-3	10S060S-306H	P109	2-1
030-0461-00.SH	P6	3-6	07-597	P16	4-4	10-3072-0-024/M	P39	1-4	11 1/2E	P59	1-1
030-0461-00(TI)	P6	3-5	07-621	P16	2-5	10-4	P35	3-4	11 1/2KM	P59	2-1
030-1310-11	P6	3-3	07-626	P16	2-4	10-5	P35	3-3	110-40052	P11	2-4
030-1311-11	P6	3-4	07-627	P16	2-3	100-01709	P12	4-7	110-40052/M	P11	2-5
0367 350070	P8	1-3	07-631	P16	2-7	100(8)[5A]	P44	2-4	110-40201	P11	3-2
0367 355050	P8	1-4	07-634	P16	2-6	100105005	P96	1-1	110-40508	P12	3-4
04007SC-5030	P109	2-1	07-702	P16	4-5	100360003	P96	2-1	110-42652	P12	3-1
04400200B000	P66	4-2	07-703	P16	4-6	100360003	P97	1-1	110-93259	P11	2-6
05-429	P17	2-5	07-707	P16	3-1	100360003	P97	2-1	110-95403	P11	4-2
05-447	P17	2-6	0745339100	P6	4-3	100360003	P98	1-1	110-96601	P12	3-3
05-548	P17	2-4	0745339110	P6	4-4	100360003	P99	2-1	110(8)[5A]	P44	3-1
05-549	P17	2-7	0745339120	P7	1-1	10036003	P98	2-1	110223	P110	1-1
05-658	P17	1-1	0745339130	P7	1-2	10036003	P99	1-1	110223	P110	1-1
05-812	P17	1-2	0745339320	P6	4-5	101-47850	P126	4-1	110034	P110	1-1
05-878	P16	4-7	0767 350360	P8	2-1	101-47759	P126	4-1	110054	P110	1-1
0580 330040	P38	4-1	0767 350580	P8	2-2	101-47858	P126	4-2	110215002	P101	1-1
0580 330050	P38	4-1	08-005	P17	2-2	101-48054	P126	4-2	110215002	P101	1-1
0580 330060	P38	4-1	08-055	P17	2-3	101-48252	P126	4-2	111-150-000	P39	1-2
0580 330070	P38	4-1	08013CL-B001	P66	4-1	101-48351	P126	4-3	111-151-000	P39	1-2
0580 330080	P38	4-1	081008-070	P96	2-1	101-1-B	P34	3-1	111-152-000	P39	1-2
0580 330090	P38	4-1	1			101491-101	P216	1-2	111-153-000	P39	1-2
0580 330100	P38	4-1	1-11(3mm)	P34	2-6	101TE	P29	4-1	111-154-000	P39	1-2
0580 330110	P38	4-1	1-121-116	P32	3-5	102-11100	P15	2-8	111-155-000	P39	1-2



索引表 PARTS LIST

INDUSTRIAL SEWING MACHINE SPARE PARTS

索引表 PARTS LIST



INDUSTRIAL SEWING MACHINE SPARE PARTS

品号 PART NO.	页数 PAGE	行数 LINE	品号 PART NO.	页数 PAGE	行数 LINE	品号 PART NO.	页数 PAGE	行数 LINE	品号 PART NO.	页数 PAGE	行数 LINE	品号 PART NO.	页数 PAGE	行数 LINE	品号 PART NO.	页数 PAGE	行数 LINE	品号 PART NO.	页数 PAGE	行数 LINE			
111-156-000	P39	1-2	116501-101	P116	3-2	118-76851	P136	4-1	118947-001	P116	2-2	12-D 1/8"21	P146	4-2	124-76301	P133	2-1	12480000	P132	3-3	134-60803	P9	1-2
111140002	P96	2-1	116502-001	P115	3-1	118-76869	P136	5-5	119-49807	P134	3-6	12-D 1/8"21	P151	4-1	124-78400	P134	2-2	12480000	P132	3-5	134-61801	P9	4-3
111140002	P97	2-1	116502-001	P118	3-4	118-76869	P136	5-1	119-49906	P134	2-6	12-D 1/8"23	P151	4-2	124-78509	P134	2-3	12480000	P132	3-5	13458500	P14	2-5
112436-001	P2	1-1	116503-001	P115	1-1	118-77156	P217	1-5	11C12-96	P62	1-3	12-D 1/8"23	P152	4-2	124-78608	P134	2-1	12480109	P132	3-4	135-15507	P102	1-1
112603-001	P114	1-2	116504-001	P116	1-2	118-77164	P217	2-1	11C12-96	P62	1-4	12-D 1/8"23T	P152	4-1	124-78707	P133	2-3	12480109	P132	3-4	135-15507	P194	2-2
112603-001	P115	1-2	116505-001	P116	1-1	118-77552	P131	4-5	12-0250-1	P153	4-1	12-D 1/8"	P143	4-3	124-78806	P132	2-4	12480109	P133	3-2	135-15564	P101	2-1
112604-001	P114	1-2	116506-101	P115	1-3	118-77578	P217	2-4	12-0330-1	P154	4-1	12-D 1/8"8	P147	4-3	124-78905	P133	2-5	12480109	P133	3-2	135-15564	P194	2-1
112604-001	P115	1-2	116507-001	P116	1-1	118-77750	P132	4-1	12-11T	P144	4-1	12-D 3/16"13	P149	4-1	124-78905	P134	2-4	12480109	P133	3-3	135-18600	P217	4-1
112605-001	P115	1-3	116508-001	P116	2-2	118-77768	P217	2-5	12-11T	P144	4-2	12-D 3/16"15	P149	4-3	124-79101	P132	2-5	12480109	P133	3-3	135-18699	P217	4-1
112638-001	P114	3-3	116509-001	P115	2-1	118-78055	P132	4-2	12-17T	P146	4-1	12-D 3/16"17	P150	4-1	12447504	P8	4-4	12480208	P133	3-4	135-18709	P217	4-1
112638-001	P115	3-2	116509-001	P118	2-3	118-78055	P136	4-5	12-17T	P150	4-2	120-04909	P9	2-7	12466157	P133	4-1	12480208	P133	3-4	135-48102	P217	4-4
112638-001	P118	3-2	116510-101	P115	2-3	118-78063	P136	5-5	12-2200-1	P221	4-1	12000410B000	P212	1-1	12466553	P133	4-3	12480208	P134	3-2	135-48151	P217	4-4
112638-001	P119	3-1	116510-101	P119	2-2	118-78063	P217	3-1	12-2290-1	P139	5-1	12000510B000	P212	1-1	12466751	P133	4-4	12480208	P134	3-2	135-48201	P217	4-4
112642-001	P114	3-3	116511-001	P116	2-1	118-79251	P131	4-2	12-3150-1	P139	5-5	12000610B000	P212	1-2	12466850	P133	4-2	12480208	P134	3-3	135-54308	P217	4-2
112642-001	P115	3-2	116511-001	P116	2-1	118-79269	P217	2-2	12-4180-1	P142	4-3	121-48607	P134	6-1	12467205	P217	3-5	12480208	P134	3-3	135-54357	P217	4-2
112642-001	P117	3-1	116511-001	P119	2-3	118-81257	P135	4-3	12-4210-1	P142	4-3	121-48607	P135	6-4	12470050	P133	4-5	12480208	P134	3-4	135-54407	P217	4-2
112642-001	P118	3-2	116512-001	P116	2-1	118-81265	P135	5-3	12-4210-1	P147	4-1	121-48706	P134	6-2	12470159	P134	4-2	12480208	P134	3-4	135-54803	P218	1-1
112642-001	P119	3-1	116512-001	P116	2-1	118-81455	P130	4-5	12-4220-1	P142	4-4	121-49803	P135	6-1	12470258	P134	4-3	12480307	P133	3-1	135-71906	P217	4-3
112645-001	P115	3-4	116512-001	P119	2-3	118-81471	P217	1-3	12-4240-1	P142	4-4	121-50306	P135	6-2	12470357	P134	4-1	12480307	P133	3-1	135-71955	P217	4-3
112645-001	P119	3-3	11702	P35	4-1	118-81554	P131	4-3	12-4260-1	P143	4-1	121-50603	P135	6-3	12473153	P134	4-4	12480406	P134	3-1	135-72003	P217	4-3
112659-001	P115	2-2	11703	P35	4-2	118-81570	P217	2-3	12-4270-1	P143	4-2	121-50702	P136	6-3	12476008	P132	3-3	12480406	P134	3-1	137-31161	P15	1-1
112659-001	P119	2-1	117133-001	P115	1-2	118-82107	P130	3-2	12-4270-1	P143	5-2	121-52450	P134	4-6	12476008	P132	3-3	12485009	P191	1-1	137-35469	P15	1-5
112660-001	P115	2-2	117133-001	P117	1-1	118-82107	P130	3-3	12-4280-1	P143	5-2	121-52451	P217	3-2	124760A6	P132	3-3	12485009	P191	1-3	137-3562	P20	2-3
112660-001	P119	2-1	117133-001	P118	1-2	118-82107	P134	3-5	12-4280-1	P143	5-2	121-52468	P134	5-6	12476107	P133	3-2	12485108	P191	1-5	138-81255	P108	1-1
112661-001	P119	2-2	117133-001	P119	1-1	118-82206	P131	3-1	12-4290-1	P143	4-2	121-52955	P217	3-3	12476107	P133	3-2	125(8)[5A]	P44	3-2	138-81255	P108	2-1
112667-001	P115	2-3	117133-001	P119	1-1	118-82404	P130	3-1	12-4290-1	P143	5-2	121-52963	P217	3-4	124761A5	P133	3-2	12514006	P128	2-3	138-81255	P12	2-3
112838-001	P117	3-1	117367-001	P115	1-2	118-82404	P131	3-2	12-4300-1	P143	4-1	121-53755	P135	4-1	12476206	P133	3-4	12515016	P128	1-3	138-82105	P108	1-1
113-043-000	P39	1-1	117367-001	P117	1-1	118-82800	P131	3-4	12-4301-1	P143	4-2	121-53755	P136	4-2	12476206	P133	3-4	1251601000	P128	3-4	138-82501	P108	1-1
113-13053	P11	4-7	117367-001	P118	1-2	118-82800	P135	3-1	12-4301-1	P143	5-2	121-53763	P135	5-1	12476206	P134	3-2	12605004	P129	1-5	138-82501	P108	2-1
113-51400	P12	4-1	117367-001	P119	1-1	118-82909	P135	3-2	12-4360-1	P143	4-1	121-53763	P136	5-2	12476206	P134	3-2	12614002	P129	2-4	138-86304	P108	2-1
113-51509	P12	4-2	117367-001	P119	1-1	118-82909	P136	3-2	12-4370-1	P143	4-1	121-54258	P135	4-2	12476206	P134	3-4	12614004	P129	2-5	138-87302	P108	2-1
114-023-000	P35	3-7	117369-001	P114	1-3	118-83006	P132	3-1	12-4380-1	P143	4-2	121-54266	P135	5-2	12476206	P134	3-4	12615004	P129	1-4	138559	P20	4-1
114-09257	P11	3-5	117369-001	P116	1-3	118-84004	P132	3-2	12-4380-1	P143	5-2	121-54266	P136	5-3	124762A4	P133	3-4	1261600800	P129	3-4	13879800-1	P66	1-4
114-09257/M	P11	3-6	117369-001	P118	1-1	118-84004	P135	3-3	12-4420-1	P147	4-2	121-54266	P136	4-3	124762B2	P134	3-4	1261601000	P129	3-5	139-47886	P15	1-4
114-09604	P11	3-7	117369-001	P118	1-3	118-84004	P136	3-3	12-4430-1	P147	4-2	121-55552	P136	4-4	124762C0	P134	3-2	12634002	P129	4-4	13E	P59	1-1
114-09604/M	P11	3-8	117369-001	P118	1-3	118-84004	P136	3-5	12-4450-1	P147	4-2	121-55560	P136	5-4	12476305	P133	3-1	12634004	P129	4-5	13EW	P60	1-1
114948-001	P114	3-1	118-2000	P9	2-1	118-85100	P131	2-1	12-4540-1	P147	4-2	121-70908	P213	2-2	12476305	P133	3-1	129-23405	P130	1-1	13KM	P59	2-1
114948-001	P114	3-5	118-45609	P9	2-3	118-85209	P131	2-4	12-4640-1	P147	4-3	121-71104	P136	3-4	124763A3	P133	3-1	129-25954	P130	5-1	14-022	P153	1-1
114948-001	P116	3-3	118-45708	P9	2-4	118-85407	P132	2-1	12-4650-1	P143	4-3	121-71500	P135	3-5	12476404	P134	3-3	129-27760	P130	4-1	14-022A	P153	1-2
114948-001	P118	3-1	118-45807	P9	3-4	118-86009	P132	2-2	12-4780-1	P144	4-3	121-72805	P135	2-1	12476404	P134	3-3	129-32307	P130	2-1	14-023	P154	1-1
114948-001	P118	3-4	118-45906	P9	3-5	118-8610	P8	3-4	12-4780-1	P148	4-2	121-73209	P135	2-2	124764A2	P134	3-3	12922704	P110	1-3	14-023A	P154	1-2
114948-001	P118	3-4	118-46003	P8	3-2	118-86504	P130	2-2	12-4980-1	P144	4-3	121-73209	P136	2-2	12476503	P134	3-1	12E	P59	1-1	14-028	P148	1-3
114950-001	P114	1-1	118-47407	P9	2-2	118-86504	P131	2-2	12-4980-1	P148	4-2	121-73308	P135	2-3	12476503	P134	3-1	12E(TFL)	P59	3-1	14-029	P148	1-3
114950-001	P114	1-3	118-47506	P9	1-6	118-87007	P130	3-2	12-4980-1	P148	4-2	121-73308	P136	2-3	124765A1	P134	3-1	12EW	P60	1-1	14-11T.N	P144	1-2
114951-001	P114	2-3	118-47605	P8	3-3	118-87106	P130	3-1	12-4990-1	P144	4-3	121-73308	P136	2-5	12476602	P133	3-3	12EW(K0)	P60	1-1	14-150	P198	3-3
114951-001	P118	2-3	118-69005	P130	5-3	118-87106	P130	3-3	12-4990-1	P148	4-2	121-73407	P213	2-1	12476602	P133	3-3	12KM	P59	2-1	14-151	P198	3-4
115-21903	P9	4-7	118-69005	P131	5-1	118-87106	P131	3-1	12-4990-1	P148	4-2	121-74207	P136	2-4	124766A0	P133	3-3	13-15/05.A	P86	1-2	14-175	P197	3-1
115-65900	P9	3-3	118-69658	P130	5-2	118-87106	P131	3-2	12-5630-1	P139	5-6	122-57507	P136	6-2	12476701	P132	3-4	13-15/05.B	P86	1-4	14-176	P197	3-2
115-66502	P8	3-1	118-69658	P131	5-2	118-87106	P131	3-3	12-5810-1	P142	4-1	122-75004	P136	6-4	12476701	P132	3-4	13-97/05.A	P86	1-1	14-177	P197	3-2



索引表 PARTS LIST

INDUSTRIAL SEWING MACHINE SPARE PARTS

索引表 PARTS LIST



INDUSTRIAL SEWING MACHINE SPARE PARTS

品号 PART NO.	页数 PAGE	行数 LINE	品号 PART NO.	页数 PAGE	行数 LINE	品号 PART NO.	页数 PAGE	行数 LINE	品号 PART NO.	页数 PAGE	行数 LINE
14-3310-1	P139	1-4	14-755	P140	1-3	14-868	P197	4-1	142-13003	P103	2-1
14-3320	P195	2-5	14-755	P141	1-4	14-870	P197	4-5	142-13003	P194	3-1
14-3320-1	P139	1-4	14-756	P140	4-2	14-871	P196	1-5	142111-001	P114	1-3
14-3330	P195	2-6	14-756	P140	4-5	14-873	P195	4-1	142416-001	P5	3-6
14-3330-1	P139	1-4	14-758	P197	1-3	14-874	P195	4-1	142419-001	P5	3-5
14-376	P152	1-2	14-760	P196	3-1	14-875	P195	4-2	144074-001	P2	1-7
14-4180-1	P142	1-3	14-763	P139	1-1	14-875	P196	3-2	144074-300	P2	2-1
14-421	P142	1-3	14-764	P140	1-1	14-876	P196	3-3	144497-001	P216	1-5
14-422	P142	1-4	14-765	P140	1-3	14-8780-1	P196	4-1	144629-001	P216	1-4
14-424	P142	1-4	14-765	P141	1-4	14-8790-1	P196	4-2	144635-001	P189	1-1
14-426	P143	1-1	14-766	P140	4-2	14-880	P139	1-3	144881-101	P115	1-3
14-427	P143	1-2	14-766	P140	4-5	14-881	P196	4-3	144881-101	P117	1-2
14-428	P143	1-2	14-768	P197	1-3	14-882	P196	4-4	144881-101	P119	1-2
14-429	P143	1-2	14-771	P197	1-4	14-883	P196	4-5	144881-101	P119	1-2
14-4301	P143	1-2	14-772	P197	1-4	14-884	P195	3-2	144882-001	P115	1-3
14-431	P143	1-2	14-773	P197	1-4	14-885	P195	3-2	144882-001	P119	1-2
14-431	P198	4-3	14-774	P197	1-4	14-886	P195	3-2	145246-001	P189	1-2
14-432	P143	1-1	14-775	P197	1-4	14-887	P195	3-3	146487-001	P221	1-1
14-436	P143	1-1	14-776	P197	2-1	14-888	P195	3-4	146489-001	P123	5-3
14-437	P143	1-1	14-777	P197	2-1	14-889	P196	1-2	146491-001	P123	5-4
14-442	P147	1-2	14-779	P197	2-2	14-890	P139	1-2	146491-001	P124	5-1
14-443	P147	1-2	14-784	P197	1-5	14-890H	P196	1-3	146496-001	P188	3-3
14-445	P147	1-2	14-785	P197	1-5	14-891	P139	1-2	146501-001	P123	1-3
14-454	P147	1-2	14-786	P197	2-4	14-892	P196	3-4	146502-001	P123	1-3
14-464	P147	1-3	14-790	P197	2-3	14-895	P196	1-4	146503-001	P123	1-3
14-465.N	P143	1-3	14-791	P197	2-3	14-896	P196	2-1	146504-001	P123	1-4
14-480.N	P144	1-3	14-800	P196	3-2	14-897	P196	2-1	146505-001	P188	3-4
14-496	P146	1-1	14-801	P196	3-5	14-929	P197	4-2	146506-001	P188	3-5
14-496.N	P144	1-3	14-802	P196	3-5	14-930	P197	4-3	146506-001	P188	4-1
14-497	P146	1-2	14-806	P141	1-1	14-D1*4	P147	1-1	146510-001	P123	1-5
14-497.N	P144	1-3	14-807	P141	1-1	14-D1/2*6	P147	1-2	146567-001	P123	3-2
14-553	P141	1-6	14-808	P141	1-1	14-D1/8*11.N	P144	1-1	146568-001	P123	3-3
14-554	P198	4-1	14-811	P197	4-4	14-D1/8*11T	P148	1-1	146569-001	P123	3-4
14-563	P139	1-5	14-812	P198	1-1	14-D1/8*12	P148	1-2	146572-001	P123	2-3
14-566	P195	2-8	14-813	P198	1-1	14-D1/8*13T.N	P145	1-1	146573-001	P123	2-4
14-567	P195	3-5	14-814	P197	4-4	14-D1/8*15T	P149	1-2	146574-001	P123	2-5
14-581	P142	1-1	14-818	P195	4-5	14-D1/8*17	P150	1-1	146577-001	P123	3-1
14-581	P198	4-2	14-819	P141	1-3	14-D1/8*17.N	P145	1-3	146577-001	P123	3-2
14-582	P198	4-2	14-820	P141	1-3	14-D1/8*21	P151	1-1	146577-001	P123	3-3
14-591	P142	1-2	14-843	P195	4-3	14-D1/8*21.N	P146	1-2	146577-001	P123	3-4
14-611	P198	1-4	14-844	P195	4-3	14-D1/8*23	P151	1-2	146730-001	P123	1-1
14-612	P198	1-4	14-845	P195	4-3	14-D1/8*23T	P152	1-1	146731-001	P123	1-1
14-613	P198	2-1	14-846	P195	4-4	14-D1/8*8	P147	1-3	146732-001	P123	1-1
14-614	P198	2-1	14-847	P195	4-4	14-D1/8*8.N	P143	1-3	146733-001	P123	1-1
14-615	P198	2-2	14-854	P140	1-2	14-D3/16*13	P149	1-1	146734-001	P188	2-5
14-616	P198	2-3	14-854C	P196	2-4	14-D3/16*15	P149	1-3	146735-001	P188	2-5
14-617	P198	2-4	14-854D	P196	2-5	14-D3/16*17	P150	1-1	146736-001	P188	2-5
14-618	P198	2-4	14-855	P140	1-4	140135	P202	1-1	146744-001	P123	3-1
14-619	P196	2-2	14-855	P141	1-5	140242-001	P2	3-1	146748-001	P123	2-1
14-724	P140	1-1	14-856	P140	4-3	14041206	P37	4-1	146773-001	P123	5-2
14-725	P140	1-3	14-856	P140	4-6	14041206M	P37	4-2	146781-001	P123	1-2
14-726	P140	4-1	14-856B	P197	3-3	140888-001	P2	3-5	146781-001	P188	1-1
14-726	P140	4-4	14-857	P197	2-5	141-03055	P111	2-1	146782-001	P123	1-2
14-728	P197	1-3	14-858	P197	4-1	141-03253	P111	2-1	146782-001	P188	1-1
14-734	P140	1-1	14-859	P196	3-1	141-03352	P111	2-1	146783-001	P188	1-1
14-735	P140	1-3	14-860	P141	1-2	141-03352	P111	2-1	146783-001	P188	2-1
14-736	P140	4-1	14-861	P196	1-1	141-03659	P111	2-1	146785-001	P188	2-2
14-736	P140	4-4	14-862	P141	1-2	141-09607	P103	2-1	146786-001	P188	2-3
14-744	P140	1-1	14-864	P140	1-2	141-16107	P218	1-1	146871-101	P123	4-3
14-745	P140	1-3	14-864B	P196	2-3	141509-101	P5	2-4	146874-101	P123	4-4
14-745	P141	1-4	14-865	P140	1-4	141514001	P101	1-1	146884-001	P123	4-1
14-746	P140	4-2	14-865	P141	1-5	141541-001	P5	3-2	146902-001	P123	4-2
14-746	P140	4-5	14-866	P140	4-3	141541-101	P5	3-3	147176-001	P116	1-2
14-748	P197	1-3	14-866	P140	4-6	141543-001	P5	3-4	147176-001	P117	1-4
14-754	P140	1-1	14-866B	P197	3-4	141546001	P100	1-1	147177-101	P116	3-2

品号 PART NO.	页数 PAGE	行数 LINE	品号 PART NO.	页数 PAGE	行数 LINE	品号 PART NO.	页数 PAGE	行数 LINE	品号 PART NO.	页数 PAGE	行数 LINE
147177-101	P117	3-5	15-437	P143	2-1	15-867	P213	2-8	153887-001	P117	2-2
147178-001	P116	2-2	15-442	P147	2-2	15-870	P139	2-4	153887-001	P119	2-2
148013-101	P123	4-5	15-443	P147	2-2	15-875	P139	3-3	1538882-001	P119	2-1
148342-001	P2	2-2	15-445	P147	2-2	15-880	P213	2-5	153892-001	P117	2-3
148681-001	P120	3-1	15-454	P147	2-2	15-881	P213	2-6	153892-001	P119	2-3
148691-001	P120	3-3	15-464	P147	2-3	15-D1/2*6	P147	2-2	153897-001	P117	2-3
148695-001	P120	3-3	15-465	P143	2-3	15-D1/8*11	P144	2-1	153897-001	P119	2-3
148699-001	P120	2-1	15-480	P144	2-3	15-D1/8*13T	P145	2-1	153907-001	P117	2-4
148699-001	P121	2-1	15-480	P148	2-2	15-D1/8*15T	P149	2-2	154568-001	P3	1-6
148703-001	P120	2-2	15-486	P148	2-2	15-D1/8*17	P145	2-3	154568-101	P3	4-2
148703-001	P121	2-2	15-496.N	P144	2-3	15-D1/8*17	P150	2-1	154569-001	P3	3-7
148705-001	P120	2-2	15-497	P144	2-3	15-D1/8*21	P146	2-2	154575-001	P3	1-5
148705-001	P121	2-2	15-497	P148	2-2	15-D1/8*21	P151	2-1	155103001	P96	1-1
148815-001	P2	2-3	15-535	P139	3-5	15-D1/8*23	P151	2-2	155453-001	P121	3-3
148864-001	P122	1-4	15-536	P139	2-6	15-D1/8*23T	P152	2-1	155457-001	P121	3-3
148865-201	P122	3-4	15-563	P141	2-5	15-D1/8*8	P143	2-3	155459-001	P121	3-3
148867-101	P122	2-4	15-565	P213	4-4	15-D1/8*8	P147	2-3	155461-001	P121	3-5
148875-001	P122	5-3	15-566	P213	4-3	15-D3/16*13	P149	2-1	155463-001	P121	3-1
148876-001-0	P122	6-1	15-581	P142	2-1	15-D3/16*15	P149	2-3	155722-001	P120	1-1
148932-101	P213	1-3	15-583	P198	4-2	15-D3/16*17	P150	2-1	155722-001	P121	1-1
148973-001	P122	5-2	15-591	P142	2-2	150666-001	P122	1-3	155851-001	P120	1-2
149671-101	P120	3-5	15-614	P213	4-6	150667-001	P122	1-5	155851-001	P121	1-2
149675-001	P120	2-3	15-615	P213	4-5	150668-101	P122	3-3	155853-001	P120	1-2
149675-001	P121	2-3	15-704	P139	2-1	150672-101	P122	3-5	155853-001	P121	1-2
149677-001	P120	1-3	15-704	P141	2-4	150673-001	P122	2-3	155855-001	P120	1-2
149677-001	P121	1-3	15-723	P140	2-1	150675-101	P122	2-5	155855-001	P121	1-2
149687-001	P120	3-3	15-723	P140	2-1	150850-001	P115	1-1	155857-001	P120	1-3
149691-001	P120	2-2	15-724	P140	2-1	150850-001	P118	1-3	155857-001	P121	1-3
149691-001	P121	2-2	15-724	P140	2-1	151076-001	P114	3-5	156036-001	P123	2-2
149938-001	P120	2-3	15-726	P140	5-2	151078-001	P144	2-3	156150-001	P189	2-1
149938-001	P121	2-3	15-727	P140	5-2	151596-001	P116	1-1	156150-001	P96	2-1
149940-001	P120	3-5	15-729	P140	5-1	151596-001	P119	1-3	156151-001	P189	2-2
149948-001	P120	2-3	15-753	P140	3-1	151597					



索引表 PARTS LIST

INDUSTRIAL SEWING MACHINE SPARE PARTS

索引表 PARTS LIST



INDUSTRIAL SEWING MACHINE SPARE PARTS

品号 PART NO.	页数 PAGE	行数 LINE	品号 PART NO.	页数 PAGE	行数 LINE	品号 PART NO.	页数 PAGE	行数 LINE	品号 PART NO.	页数 PAGE	行数 LINE
159276-001	P5	3-8	17-3760-1	P143	3-1	18-4260-1	P143	6-1	19-4960-1	P148	5-2
159540-001	P3	3-4	17-3760-1	P216	4-3	18-4270-1	P143	6-2	19-4960-1	P148	5-2
159541-001	P3	3-3	17-3770-1	P143	3-2	18-4280-1	P143	6-2	19-4970-1	P144	5-3
159575-101	P121	3-5	17-3810-1	P143	3-2	18-4290-1	P143	6-2	19-4970-1	P148	5-2
159577-001	P116	1-1	17-3820-1	P143	3-1	18-4301-1	P143	6-2	19-4970-1	P148	5-2
159577-001	P117	1-3	17-3890-1	P147	3-2	18-4310-1	P143	6-2	19-D1/2"	P147	5-2
159577-001	P119	1-3	17-3900-1	P147	3-2	18-4320-1	P143	6-1	19-D1/8*11	P144	5-1
159577-001	P119	1-3	17-3910-1	P147	3-2	18-4360-1	P143	6-1	19-D1/8*13T	P145	5-1
159799-001	P3	4-1	17-3930-1	P143	3-3	18-4370-1	P143	6-1	19-D1/8*15T	P149	5-2
159915-001	P3	3-5	17-3960-1	P144	3-3	18-4420-1	P147	6-2	19-D1/8*17	P145	5-3
15E	P59	1-1	17-3960-1	P148	3-2	18-4450-1	P147	6-2	19-D1/8*17	P150	5-1
15KM	P59	2-1	17-3970-1	P144	3-3	18-4640-1	P147	6-3	19-D1/8*21	P146	5-2
164-01002(1.0)	P13	1-3	17-3970-1	P148	3-2	18-4650-1	P143	6-3	19-D1/8*21	P151	5-1
164-03008(1.0)	P13	1-4	17-4280-1	P143	3-2	18-4800-1	P144	6-3	19-D1/8*23	P151	5-2
164-16109	P13	1-7	17-4450-1	P147	3-2	18-4800-1	P148	6-2	19-D1/8*23	P152	5-2
164-16109.SH	P13	1-8	17-4640-1	P147	3-3	18-4960-1	P144	6-3	19-D1/8*23T	P152	5-1
164-18600	P13	1-5	17-4780-1	P144	3-3	18-4960-1	P148	6-2	19-D1/8*8	P143	5-3
164-18600.SH	P13	1-6	17-4780-1	P148	3-2	18-4960-1	P148	6-2	19-D1/8*8	P147	5-3
164-18709	P13	4-1	17-5060-K	P17	2-1	18-4970-1	P144	6-3	19-D3/16*13	P149	5-1
164-18709.SH	P13	4-2	17-5630-1	P139	4-5	18-4970-1	P148	6-2	19-D3/16*15	P149	5-3
16409906	P13	4-5	17-5760-1	P142	3-2	18-4970-1	P148	6-2	19-D3/16*17	P150	5-1
164178	P211	3-4	17-5810-1	P142	3-1	18-D1/8*11	P144	6-1	19S01-019G01(1/4)	P212	4-3
164550	P27	4-4	17-7200-1	P139	4-1	18-D1/8*13T	P145	6-1	19S09-005P01	P33	3-7
164728	P27	4-1	17-7680-1	P139	4-2	18-D1/8*15T	P149	6-2			
1650-161-RT	P29	4-5	17-7680-1	P139	4-2	18-D1/8*17	P145	6-3	200954	P202	1-1
1650004-229	P28	4-6	17-7690-1	P139	4-3	18-D1/8*17	P150	6-1	200959	P20	2-4
166-07301(A-1)	P13	2-1	17-8770-1	P216	4-1	18-D1/8*21	P146	6-2	200971	P20	4-2
166-07301.SH(A-1)	P13	2-3	17-9290-1	P216	4-4	18-D1/8*21	P151	6-1	201121A	P20	4-5
166-07400(A-2)	P13	2-2	17-9300-1	P216	4-5	18-D1/8*23	P151	6-2	201121AO	P20	4-7
166-07400.SH(A-2)	P13	2-4	17-D1/2"	P147	3-2	18-D1/8*23	P152	6-2	201121ANS	P20	4-6
166-07509(B-1)	P13	2-5	17-D1/8*11	P144	3-1	18-D1/8*23T	P152	6-1	201127	P20	1-5
166-07509.SH(B-1)	P13	3-1	17-D1/8*13T	P145	3-1	18-D1/8*8	P143	6-3	201152E/201155C	P156	4-3
166-07608(B-2)	P13	2-6	17-D1/8*15T	P149	3-2	18-D1/8*8	P147	6-3	201152E/201155C	P158	4-6
166-07608.SH(B-2)	P13	3-2	17-D1/8*17	P145	3-3	18-D3/16*13	P149	6-1	201152E/2771103	P163	4-4
166-07707(C-1)	P13	3-3	17-D1/8*17	P150	3-1	18-D3/16*15	P149	6-3	201152E/277115	P163	4-4
166-07707.SH(C-1)	P13	3-5	17-D1/8*21	P146	3-2	18-D3/16*17	P150	6-1	201152E/201155CP162	4-1	
166-07806(C-2)	P13	3-4	17-D1/8*21	P151	3-1	1802	P33	2-1	20119008	P15	4-3
166-07806.SH(C-2)	P13	3-6	17-D1/8*23	P151	3-2	181716-001	P122	4-3	201230C/201224B	P157	4-1
166150-001(2.2)	P189	2-3	17-D1/8*23	P152	3-2	181722-001	P221	1-3	201230C/201224B	P159	4-1
166150-001(2.6)	P189	2-3	17-D1/8*23T	P152	3-1	183954-001	P122	4-1	201230C/201310A	P156	4-4
166150-001(2.8)	P189	2-3	17-D1/8*8	P143	3-3	183978-001	P122	4-2	201230C/201396B	P156	4-4
16G-8	P35	3-8	17-D1/8*8	P147	3-3	19-025	P153	5-1	201230C/205525	P156	4-6
17-0064-5-849	P39	3-2	17-D3/16*13	P149	3-1	19-033	P154	5-1	201230C/205525	P159	4-2
17-0064-5-852	P39	3-2	17-D3/16*15	P149	3-3	19-11T	P144	5-2	201230C/208050A	P159	4-6
17-0064-5-854	P39	3-2	17-D3/16*17	P150	3-1	19-11T	P148	5-1	201230C/210370	P163	4-2
17-0064-5-855	P39	3-2	172020201	P67	1-3	19-17T	P146	5-1	201230C/210371	P163	4-2
17-0064-5-856	P39	3-2	172020226	P67	1-4	19-17T	P150	5-2	201230C/210374	P163	4-2
17-0064-5-858	P39	3-2	179458-05	P21	3-2	19-4140-1	P144	5-3	201230C/210374	P164	4-2
17-0064-5-863	P39	2-5	179459-05	P21	3-1	19-4140-1	P148	5-2	201230C/210503	P164	4-2
17-0064-5-864 3/5CP39	2-3		179630-92	P163	5-2	19-4180-1	P142	5-3	201230C/205525P161	4-5	
17-0064-5-864 3/5CB39	2-4		179630-92	P164	5-1	19-4210-1	P142	5-3	201230C/2103710	P162	4-2
17-0064-5-951	P39	3-2	179630-920	P161	5-4	19-4210-1	P147	5-1	201308	P21	4-3
17-0460-1	P148	3-3	179630-920	P162	5-1	19-4220-1	P142	5-4	201473B/301433	P159	4-3
17-0470-1	P148	3-3	179630-920	P165	6-1	19-4240-1	P142	5-4	202142-0-10	P23	1-7
17-11T	P144	3-2	18-025	P153	6-1	19-4260-1	P143	5-1	202143-0-10	P23	2-7
17-11T	P148	3-1	18-033	P154	6-1	19-4300-1	P143	5-1	202146-0-10	P22	3-2
17-17T	P146	3-1	18-11T	P144	6-2	19-4320-1	P143	5-1	202194-0-11	P24	2-3
17-17T	P150	3-2	18-11T	P148	6-1	19-4360-1	P143	5-1	202296	P20	1-2
17-3010-1	P216	4-2	18-17T	P146	6-1	19-4420-1	P147	5-2	202296(HSS)	P20	1-2
17-3610-1	P139	4-4	18-17T	P150	6-2	19-4430-1	P147	5-2	202296	P20	1-4
17-3710-1	P142	3-3	18-4180-1	P142	6-1	19-4450-1	P147	5-2	202403	P202	1-2
17-3710-1	P147	3-1	18-4210-1	P142	6-1	19-4540-1	P147	5-2	202451	P21	4-4
17-3720-1	P142	3-4	18-4210-1	P147	6-1	19-4640-1	P147	5-3	202495E1	P162	1-3
17-3740-1	P142	3-4	18-4220-1	P142	6-2	19-4650-1	P143	5-3	202527A	P20	4-3
17-3750-1	P142	3-3	18-4240-1	P142	6-2	19-4960-1	P144	5-3	202546E	P157	1-1

品号 PART NO.	页数 PAGE	行数 LINE	品号 PART NO.	页数 PAGE	行数 LINE	品号 PART NO.	页数 PAGE	行数 LINE	品号 PART NO.	页数 PAGE	行数 LINE
202546E	P159	1-1	204394	P161	3-1	204730	P159	2-2	208060	P158	3-5
202546E1	P162	1-2	2043940	P163	3-1	204730-BF	P156	2-2	208060	P160	3-4
202554E	P157	1-2	204396	P160	3-3	204730-BF	P158	2-6	208060	P161	3-4
202554E	P159	1-5	204396	P157	3-6	204730-BF0	P162	2-1	2080600	P162	3-4
202554E	P202	2-4	204396	P158	3-5	2047300	P161	2-5	208061	P158	3-1
202554E-H	P202	2-4	204396	P160	3-4	204730A16F	P159	2-3	208061	P161	3-2
202554E-T	P201	2-1	204396	P161	3-4	204731A	P202	1-4	208061	P161	3-3
202554E1	P162	1-3	2043960	P162	3-4	20491	P31	1-3	208063	P157	3-4
202570	P20	4-4	204420	P158	2-1	204931	P158	3-1	208063	P158	3-2
202617	P156	1-3	204420	P161	2-2	204931	P161	3-2	208063	P160	3-5
202618	P202	1-3	204420	P161	2-3	204931	P161	3-3	208063	P214	2-3
202618A	P159	1-3	204425	P160	3-3	204939	P158	1-1	2080630	P162	3-5
202675	P156	1-4	204502A	P161	4-3	204939-02	P201	3-7	208064	P157	3-5
202702	P156	1-4	204528	P158	1-4	204940	P161	1-2	208064	P158	3-3
202702	P156	1-4	204528	P161	1-1	204940	P161	1-3	208064	P158	3-4
20271	P31	2-7	204529	P158	1-4	204941	P158	1-1	208064	P161	3-1
202733	P214	2-1	204529	P161	1-1	204941-2	P201	4-1	2080640	P163	3-1
202734	P214	2-1	204529-2	P201	3-3	204943	P202	3-5	208065	P160	3-3
202799/205525	P162	4-1	204529-T	P201	3-5	204944	P202	3-5	208066	P157	3-6
202799/205525	P164	4-1	2045291	P163	1-1	204945	P202	3-5	208066	P158	3-5
202799/210371	P163	4-3	204674	P156	3-2	20496	P30	4-7	208066	P160	3-4
202799/210372	P163	4-3	204674	P156	3-3	205243	P157	1-3	208066	P161	3-4
202893	P20	1-1	204674	P157	3-1	205253/201310A	P157	4-3	2080660	P162	3-4
202893(HSS)	P20	1-1	204674	P157	3-2	205253/209734	P160	4-2	208074	P158	3-1
202932-0-10	P23	2-2	204674	P158	3-6	205255	P157	1-2	208074	P161	3-2
202983	P160	1-1	204674	P159	3-1	205255	P159	1-5	208074	P161	3-3
203010-0-10	P23	3-1	204674	P159	3-3	205321	P159	1-4	208078-BF	P157	3-1
203012-0-10	P22	3-7	204674	P159	3-5	205465	P156	1-5	208078-BF	P157	3-2
203066-0-10	P23	2-3	204674	P159	3-6	205465	P159	1-2	208078-BF	P159	3-1
203069-0-10	P22	4-4	2046740	P162	3-1	2054651	P156	1-1	208078-BF	P159	3-5
203144-0-10	P22	3-5	2046740	P162	3-2	205609	P20				



索引表 PARTS LIST

INDUSTRIAL SEWING MACHINE SPARE PARTS

索引表 PARTS LIST



INDUSTRIAL SEWING MACHINE SPARE PARTS

品号 PART NO.	页数 PAGE	行数 LINE	品号 PART NO.	页数 PAGE	行数 LINE	品号 PART NO.	页数 PAGE	行数 LINE	品号 PART NO.	页数 PAGE	行数 LINE	品号 PART NO.	页数 PAGE	行数 LINE	品号 PART NO.	页数 PAGE	行数 LINE	品号 PART NO.	页数 PAGE	行数 LINE			
208508S	P219	1-1	209352-0-10	P23	2-6	210839	P202	4-1	213108A	P20	3-3	228-17159	P128	3-3	257030B48	P167	1-5	257266-16F	P168	2-3	257517-40	P169	5-4
208508	P158	4-1	209354-0-10	P23	3-4	210839-2	P201	4-3	213111-60	P202	2-3	228-20302	P15	3-2	257030B48	P169	1-4	257267-16F	P168	2-2	257517-40	P170	5-1
208508	P161	4-2	209355-2-01	P23	4-5	210840	P202	4-1	2150256	P30	4-8	228-50356	P12	3-1	257030B48	P203	3-5	257267-16F	P168	2-3	257517-48	P166	5-4
208525	P156	4-3	209356-0-00	P23	2-5	210840-2	P201	4-5	2151024	P32	2-4	23026	P120	3-4	257031B56	P203	4-2	257267-16F	P168	2-3	257517-48	P167	5-5
208525	P156	4-4	209357-2-01	P24	1-3	210845	P202	4-2	2151025	P32	2-3	23136005	P14	3-1	257032B56	P203	3-5	257268-16F	P168	2-4	257517-48	P168	5-3
208525	P156	4-5	2094116-25F	P159	3-6	210846	P202	4-2	2157057	P220	3-3	23138209	P14	2-7	257033A56	P203	4-3	257289-16F	P169	2-1	257517-48	P169	5-1
208525	P156	4-6	209417A25F	P159	2-6	210847	P202	4-2	2157058	P220	3-3	235-06009	P12	4-3	257033A64	P203	4-3	257290-16F	P169	2-1	257517-48	P169	5-4
208525	P157	4-1	209425-2-01	P23	4-7	210847-2	P201	4-7	2157086	P220	2-5	235-06108	P12	4-4	257033B56	P168	1-1	257291-16F	P169	2-3	257517-48	P170	5-1
208525	P157	4-2	209508-45	P159	1-6	210848	P202	4-2	2157116	P220	3-4	236606	P20	3-6	257033B56	P169	1-5	257292-16F	P169	2-3	257518-48	P166	5-5
208525	P157	4-3	209509-25F	P159	3-6	210868	P202	4-3	2157118	P220	3-4	236606(HSS)	P20	3-6	257033B64	P168	1-1	257292-16F	P169	2-3	257518-48	P168	5-2
208525	P158	4-6	209670	P222	1-1	2109000	P181	2-4	2157310	P220	4-1	236608	P20	3-5	257033B64	P169	1-5	257293-16F	P169	2-4	257518-56	P166	5-5
208525	P159	4-1	209670-92	P156	5-3	2109000	P214	4-3	2157315	P220	4-2	236608(HSS)	P20	3-5	257033C56-18	P203	4-4	257317A32	P167	4-3	257518-56	P167	5-1
208525	P159	4-2	209670-92	P156	5-5	2109001	P181	3-4	2158003	P208	3-3	236618	P20	3-7	257033C56-20	P203	4-5	257317A32	P169	4-4	257518-56	P167	5-2
208525	P159	4-3	209670-92	P157	5-1	2109001/2109052	P214	4-4	2158011	P208	3-4	236618(HSS)	P20	3-7	257049B32	P168	1-3	257318A40	P167	4-4	257518-56	P167	5-3
208525	P159	4-4	209670-92	P158	5-5	2109005	P181	2-6	2159102	P223	4-1	236631-56	P222	1-7	257050B40	P168	1-3	257318A40	P169	4-4	257518-56	P168	5-1
208525	P159	4-5	209670-92	P159	5-1	2109005	P215	1-1	2159111	P223	4-2	23C1-19	P61	2-1	257050B48	P168	1-3	257318A48	P167	4-4	257518-56	P168	5-4
208525	P159	4-6	209732	P160	1-2	2109006	P181	3-5	2159112	P223	4-3	241372	P211	3-3	257051B48	P168	1-2	257318A48	P169	4-4	257518-56	P169	5-2
208525	P160	4-1	209740-16F	P160	3-2	2109006/2109052	P215	1-2	2169113	P223	4-4	24306	P53	1-2	257053B56	P168	1-4	257321A56	P168	4-1	257518-56	P169	5-3
208525	P160	4-2	209741-16F	P160	3-2	2109007	P181	2-5	21787	P208	1-5	246-2553	P6	4-6	257053B64	P168	1-4	257321A56	P169	4-5	257518-56	P169	5-5
208648	P158	1-5	209742-16F	P160	2-2	2109050	P214	4-5	2200850222	P18	1-2	246-2553.SH	P6	4-7	257067B56	P204	1-1	257321A64	P168	4-1	257518-56	P170	5-2
208648	P161	1-4	20RAS261	P29	4-6	2109051/2109052	P214	4-6	2200850227	P17	4-1	246-2553(TI)	P6	4-6	257082B56	P203	2-2	257321A64	P169	4-5	257518-64	P166	5-5
208649	P158	4-5	21-3003	P34	1-6	2109067	P181	3-4	2206110119	P17	3-4	246061	P32	3-1	257090B56	P167	1-2	257327A32	P168	4-3	257518-64	P167	5-2
208649	P161	4-4	21-4001	P34	1-7	2109067	P181	3-5	2206110120	P18	1-3	246071	P32	3-2	257090B64	P167	1-2	257328A40	P168	4-3	257518-64	P168	5-1
208730/208731	P156	4-5	2100167	P30	1-1	2109100	P181	5-2	22100802372	P18	1-1	24741	P43	2-1	257090C56	P167	1-3	257328A48	P168	4-3	257518-64	P168	5-4
208730/208731	P157	4-2	2100167[HSS]	P30	1-1	2109101	P223	2-1	2210090242	P17	3-1	24C1-3	P61	2-5	257097B56	P169	1-3	257330A48	P168	4-2	257518-64	P169	5-2
208730/208731	P159	4-5	2101155	P32	1-6	2109102	P223	2-2	22195	P30	1-4	25-14	P28	3-2	257097B64	P169	1-3	257331A56	P168	4-4	257518-64	P169	5-3
208730/208732	P157	4-2	2101156	P32	1-5	2109110	P223	2-3	225-57458	P107	2-1	252058-92	P166	6-3	257100B40	P170	1-1	257331A64	P168	4-4	257518-64	P169	5-5
208730/208732	P159	4-5	2101220	P32	1-1	2109112	P223	3-2	225-57557	P107	2-1	252059-92	P166	7-1	257100B48	P170	1-1	257350-32	P219	1-2	257518-64	P170	5-2
2087300/2087321	P162	4-3	2101221	P32	1-2	2109120	P223	3-4	225-57557	P12	4-5	253647	P28	1-2	257102B56	P170	1-2	257460-32	P166	4-4	257522-64	P166	5-3
208905	P156	5-4	2107032	P181	4-4	2109122	P223	3-5	225-57706	P107	2-1	253775	P27	4-7	257102B64	P170	1-2	257460-32	P169	4-1	257542-56	P170	5-3
208905	P157	5-2	2107100	P220	3-5	2109132	P223	3-3	225-57706	P12	4-6	25492	P52	1-4	257102C56	P204	1-2	257460-40	P166	4-4	257542-561	P222	1-6
208905	P159	5-2	2107102	P220	3-6	210980	P202	4-4	225-57805	P107	2-1	255344	P40	1-6	257102C6400	P204	1-2	257460-40	P169	4-1	257542-64	P170	5-3
208905	P160	5-1	2107290/2107240	P220	3-1	210981	P202	4-4	225-57904	P107	2-1	2560	P35	3-1	257105B56	P203	3-1	257460-48	P166	4-4	257573	P21	1-7
208905A92	P160	5-2	2107300	P181	4-5	210982	P202	4-4	225-58001	P107	2-1	256035B56	P203	3-3	257105B64	P203	3-1	257480-48	P169	4-1	257573A	P21	1-8
208906A92	P159	5-3	2107301	P181	4-6	210986	P202	4-5	225-58100	P107	2-1	25626	P34	3-2	257108B56	P203	3-2	257461-48	P166	4-5	257574	P21	2-1
208909	P157	5-3	2107308	P220	3-2	210986	P203	1-1	225-58209	P107	2-1	25655	P34	3-3	257108B64	P203	3-2	257461-56	P166	4-5	259100-16F	P170	3-1
208909	P158	5-1	2107309	P220	3-2	210987	P202	4-5	225-58308	P107	2-1	2569	P35	3-2	257111C48	P203	1-4	257461-56	P167	4-1	259101-16F	P170	3-2
208909B92	P160	5-3	2107355	P21	1-3	2110305	P30	1-2	225-58308	P193	4-2	257001B56	P203	2-1	257180-64	P166	1-3	257461-56	P169	4-2	259103-16F	P169	3-2
208909B92	P161	5-2	210783	P202	1-5	2111055	P32	1-4	225-58407	P107	2-1	257015B32	P166	1-4	257203A16F	P168	3-5	257461-64	P166	4-5	259106-16F	P214	2-6
208910	P158	5-2	210784	P202	1-5	2111056	P32	1-3	225-58407	P193	4-1	257015B32	P169	1-1	257206-16F	P166	3-4	257461-64	P169	4-2	259110-16F	P170	3-3
208910	P158	5-3	210796	P202	2-1	2111407-553-A	P28	4-1	22548010A	P191	3-5	257015B40	P166	1-4	257207-16F	P166	3-5	257461-64	P167	4-2	259128-16F0	P214	2-4
208910B92	P160	5-4	210797	P202	2-1	2111407-553-B	P28	4-2	22548119A	P213	1-4	257015B40	P169	1-1	257207-16F	P167	3-1	257468-56	P167	4-2	259136-16F	P166	3-3
208910B92	P161	5-1	210799	P202	2-2	2111417-556-B	P28	4-3	22581409S.A	P191	3-4	257015B48	P166	1-4	257214-16F	P167	3-2	257468-56	P169	4-3	259202-16F	P170	2-1
208911	P156	3-4	210800	P202	2-2	2114012	P32	2-2	22581508A	P213	1-5	257015B48	P169	1-1	257215-16F	P167	3-3	257468-64	P167	4-2	259203-16F	P170	2-2
208911	P159	3-2	2108000	P181	1-4	2114013	P32	2-1	22581508S	P213	1-6	257015C56	P203	2-4	257216-16F	P168	3-1	257468-64	P169	4-3	259215-16F	P169	2-2
2089110	P161	3-5	2108002	P181	1-5	211662	P21	1-4	226-40353	P126	3-2	257016B48	P166	1-5	257220-16F	P168	3-3	257485-40	P170	4-1	259218A16F	P214	2-7
208912	P156	3-4	2108003	P181	1-6	211662A	P21	1-5	226-40353	P127	3-1	257016B56	P166	1-5	257221-16F	P168	3-2	257485-48	P170	4-1	259234-16F0	P214	2-5
208912	P159	3-2	2108004	P208	2-5	2118009	P208	4-3	226-40551	P126	3-2	257018A56	P167	1-1	257221-16F	P168	3-3	257486-56	P170	4-2	259246-16F	P166	2-3
2089120	P161	3-5	2108005	P208	2-5	2119000/2119015	P214	4-2	226-40551	P127	3-1	257018B56	P166	1-6	257221-16F	P168	3-3	257486-64	P170	4-2	259608B56	P204	1-4
208914	P222	1-2	2108006	P208	3-2	2119002	P214	4-1	226-40858	P126	3-2	257018B56	P169	1-2	257222-16F	P168	3-4</						



索引表 PARTS LIST

INDUSTRIAL SEWING MACHINE SPARE PARTS

索引表 PARTS LIST



INDUSTRIAL SEWING MACHINE SPARE PARTS

品号 PART NO.	页数 PAGE	行数 LINE	品号 PART NO.	页数 PAGE	行数 LINE	品号 PART NO.	页数 PAGE	行数 LINE	品号 PART NO.	页数 PAGE	行数 LINE
2701-P9-113/1	P22	3-5	277315-16F	P164	3-1	277519R40	P203	1-3	3108003	P185	1-3
274018-92B	P162	4-1	277318-13	P163	3-2	277524T50	P165	1-3	3108130	P182	1-1
274018-92B	P163	4-2	277318-13	P163	3-3	277524T60	P165	1-3	3108131	P182	1-1
274018-92B	P163	4-3	277318-13	P163	3-5	279-112	P23	2-3	3108132	P182	1-1
274018-92B	P163	4-4	277318-13	P164	3-2	279-113/1	P22	4-4	3108133	P209	2-2
274018-92B	P164	4-1	277318-13	P164	3-3	282188	P211	3-5	3108134	P182	1-2
274018-92B	P164	4-2	277318-13	P165	3-1	290-112	P23	2-1	3108134(厚舌)	P209	2-3
274018-92B	P164	4-3	277318-13	P165	3-2	290-113	P23	1-6	3108134H	P209	2-3
274018-92B0	P161	4-5	277318-13	P165	3-3	290-113SP	P22	4-5	3108134N	P209	2-4
274018-92B0	P162	4-1	277318-130	P165	3-4	260010	P21	2-2	3108134D	P209	2-4
274018-92B0	P162	4-2	277318-130	P166	3-1	2Q0018B56D	P170	1-3	3108135	P209	2-2
274018-92B0	P162	4-3	277318-130	P166	3-2	2Q0018B56D0	P204	1-3	3108136	P210	1-5
276B-112	P23	2-2	277318A13	P163	3-4	2Q0018B64D	P170	1-3	3108140-NS	P210	1-1
277-112	P23	3-1	2773200	P166	4-2	2Q0018B64D0	P204	1-3	3108141-N	P210	1-1
277-113	P22	3-7	277323-16	P164	3-3	3	3108142-LN	P209	2-5		
277000	P21	1-2	277323-160	P166	3-2	3C08021	P209	4-4	3208023	P210	3-1
277009	P20	2-5	277324-16	P164	3-3	3C08025	P210	3-4	3208094	P210	4-1
277022-92	P164	5-2	277324-160	P166	3-2	301006	P21	2-4	3208096	P210	2-5
277022-920	P162	5-2	277325-16	P164	2-3	301008	P21	2-3	3208097	P210	2-5
277022-920	P166	6-1	277325-160	P166	2-2	301035	P21	2-6	3208103	P182	1-3
277027-92	P164	5-3	277327-16	P165	3-1	301036	P21	2-5	3208108	P182	1-2
277027-92	P165	5-1	277327-16	P165	3-3	301138	P22	2-3	3208109	P182	1-2
277027-920	P166	6-2	277328-16	P165	3-1	3021060	P32	1-7	3208109	P183	2-5
277027-921	P162	5-3	277328-16	P165	3-3	3021061	P32	1-8	3209001	P182	2-1
277028-92	P165	5-2	277329-16	P165	2-2	3021109	P30	3-1	3209001	P182	2-5
277029-92	P165	5-3	277329-16	P165	2-4	3021109[HSS]	P30	3-1	3209002	P215	1-6
277029-920	P162	5-4	277330-16	P165	2-1	3021111	P30	3-2	3209003	P215	1-5
277029-920	P163	5-1	277337-25	P165	3-2	3021111[HSS]	P30	3-2	3209004	P182	3-3
277030-92	P165	5-4	277338-25	P165	3-2	3027092	P186	4-4	3209005	P182	2-3
277031-92	P222	1-3	277339-25	P165	2-3	3027095	P186	4-4	3209006	P215	2-2
277112/208651	P164	4-3	2773440	P165	4-5	3027140	P186	4-5	3209007	P215	2-1
277118	P164	4-1	2773450	P166	4-1	3027143	P186	4-5	3209008	P182	3-4
277118	P165	4-1	277500P30	P163	1-2	3028015	P186	1-6	3209008	P183	3-1
2771180	P162	4-4	277500P30	P163	1-5	3028016	P186	1-6	3209008	P183	3-1
277118A0	P165	4-4	277500P40	P163	1-2	302807-0-10	P24	2-1	3209009	P182	2-4
277119	P165	4-2	277500P40	P163	1-5	302808-0-10	P22	3-6	3209009	P182	2-4
2771190	P162	4-5	277502P15	P164	1-2	302865-0-11	P24	2-2	3209009	P183	2-1
277122	P165	4-3	277502P15	P202	3-4	3029019	P186	2-5	3209009	P182	2-1
2771220	P163	4-1	277504R30	P163	1-3	303-65407	P11	1-2	3209065	P182	2-2
277149-400	P165	5-5	277504R40	P163	1-3	303131	P22	2-4	3209065	P183	2-2
277151-400	P166	5-1	277504R40	P165	1-5	303360	P21	3-3	3209080	P182	3-1
277153-400	P166	5-2	277504R50	P163	1-3	303363	P21	3-4	3209100	P223	2-5
277300-16F	P163	3-2	277504R50	P163	1-4	30421	P30	1-5	3209101	P182	5-5
277300-16F	P163	3-5	277504R60	P163	1-4	305-00300	P11	1-1	3209102	P182	5-4
277301-16F	P163	3-2	277505R30	P164	1-3	305266	P22	2-1	3209106	P223	3-1
277301-16F	P163	3-3	277505R30	P202	3-3	305267	P22	2-2	3209107	P182	5-6
277301-16F	P164	3-1	277505R40	P164	1-3	306283-2-00	P23	1-1	3209107	P183	5-1
277302-16F	P163	2-2	277505R40	P164	1-4	306394	P21	1-6	3209107	P183	5-2
277302-16F	P163	2-4	277505R40	P202	3-3	308026-91	P21	3-6	3209108	P183	5-2
277302-16F	P164	2-1	277505R400	P166	1-1	308030	P21	3-5	32666	P208	1-1
277303-16F	P163	3-3	277505R50	P164	1-3	3100512	P31	3-7	32667	P208	1-1
277303-16F	P164	3-2	277505R50	P164	1-4	3100513	P31	3-5	32671	P207	4-4
277303-16F0	P165	3-4	277505R50	P202	3-3	3101026	P30	2-1	32672	P207	4-4
277303-16F0	P166	3-1	277505R60	P202	3-3	3101028	P31	1-8	32673	P207	4-4
277303A16F	P163	3-4	277512P15	P164	1-1	3101465	P31	1-7	32678	P208	2-1
277304-16F	P163	3-3	277512P15	P202	3-4	3101633	P30	2-2	3268014	P210	3-3
277304-16F	P163	3-4	277513R40	P164	1-5	3101633[HSS]	P30	2-2	32706	P31	2-6
277304-16F0	P166	3-2	277513R400	P166	1-2	3101699	P31	4-5	327WF-001	P33	3-8
277304-16F0	P165	3-4	277513R50	P164	1-5	3101700	P31	4-6	32914	P31	1-1
277304-16F0	P166	3-1	277513R50-N	P203	1-2	3101801	P31	3-3	32914-7	P31	1-2
277305-16F	P163	2-3	277516R50	P165	1-2	3101802	P31	3-4	33353	P208	2-1
277305-16F	P164	2-2	277516R60	P165	1-2	3106000	P215	1-4	33353A(4mm)	P208	2-2
277305-16F0	P165	2-5	277517R40	P165	1-1	3107273	P186	4-1	33353A(5mm)	P208	2-2
277305-16F0	P166	2-1	277517R50	P165	1-1	3107274	P186	4-1	33541	P208	4-4
277309-13	P164	3-1	277518R40	P165	1-4	3108002	P185	1-2	33545	P208	4-5

品号 PART NO.	页数 PAGE	行数 LINE	品号 PART NO.	页数 PAGE	行数 LINE	品号 PART NO.	页数 PAGE	行数 LINE	品号 PART NO.	页数 PAGE	行数 LINE
32062507	P37	4-3	340406	P21	4-1	36224A-1	P212	1-3	400-22322	P107	1-1
32062606	P37	4-3	340468	P21	4-2	36250	P29	1-6	400-22323	P107	1-1
32062705	P37	4-3	34566	P207	4-5	36270	P29	2-4	400-23020	P13	4-8
32062804	P37	4-3	34598	P208	2-3	36270B	P29	2-5	400-25485	P126	1-1
32062903	P37	4-3	34749A	P29	1-2	36278D	P22	1-3	400-25485	P126	1-4
32063000	P37	4-3	34749EL	P8	4-1	36279	P207	4-3	400-25485	P127	1-3
32063109	P37	4-3	34893	P207	4-3	36304	P208	2-4	400-25490	P126	1-2
32063208	P37	4-3	34894	P207	4-3	36415	P30	4-5	400-25490	P127	1-1
32063307	P37	4-3	350018-91	P21	4-6	3650-001	P29	4-3	400-25492	P126	1-2
32063406	P37	4-3	350024	P21	4-5	3650-303	P29	4-4	400-25492	P127	1-1
32063505	P37	4-3	350081	P22	1-4	37231-033	P35	2-6	400-25494	P126	1-2
3207151	P182	4-3	350083	P22	1-5	37289	P207	4-6	400-25494	P127	1-1
3207156	P183	4-2	3501026	P30	2-6	37469	P30	4-3	400-25494	P128	1-1
3207157	P183	4-2	3501032	P31	2-2	37469[HSS]	P30	4-3	400-25495	P126	1-3
3208026	P210	3-5	3501534	P31	2-5	37472	P30	4-1	400-25495	P127	1-2
3208093	P210	4-1	3501535	P31	2-4	37472[HSS]	P30	4-1	400-25495	P128	1-2
3208094	P210	4-1	3501596	P31	2-6	37483	P207	4-6	400-25498	P127	1-2
3208096	P210	2-5	3501597	P31	2-3	37496	P220	4-4	400-25498	P128	1-2
3208097	P210	2-5	350218	P22	1-2	37514	P30	4-2	400-25499	P127	1-2
3208103	P182	1-3	350218[HSS]	P22	1-2	37538	P30	1-7	400-25499	P128	1-2
3208108	P183	1-2	350220	P22	1-1	38249A	P29	1-5	400-25500	P127	1-2
3208109	P183	1-2	350452-0-00	P23	1-3	39270A	P29	1-7	400-25500	P128	1-2
3209000	P182	3-5	350453-0-00	P23	1-4	39270D	P29	2-1	400-25817	P126	2-1
3209001	P182	2-1	3507000-N	P184	4-3	39270E	P29	2-2	400-25817	P126	2-4
3209001	P182	2-5	3507002-N	P184	4-4	39270K	P29	2-3	400-25818	P126	2-2
3209002	P215	1-6	3507050-N	P184	4-5	39549	P29	1-1	400-25818	P127	2-1
3209003	P215	1-5	3507052-N	P184	4-6	39549J	P29	1-4	400-25821	P126	2-2
3209004	P182	3-3	3507052-N	P186	4-3	39549N	P29	1-3	400-25821	P127	2-1
3209005	P182	2-3	3507054-N	P185	4-1	39570	P29	2-6	400-25822	P126	2-3
3209006	P215	2-2	3507060	P185	4-5	39570J	P29	3-1	400-25822	P127	2-2
3209007	P215	2-1	3507064	P185	4-6	39570K	P29	3-2	400-25824	P127	2-2
3209008	P182	3-4	3507064	P186	4-1	39570L	P29	3-3	400-25825	P127	2-2
3209008	P183	3-1	3507064	P186	4-2	396 351690	P7	4-5	400-25826	P127	2-2
3209008	P183	3-1	3507108	P185	4-						



索引表 PARTS LIST

INDUSTRIAL SEWING MACHINE SPARE PARTS

索引表 PARTS LIST



INDUSTRIAL SEWING MACHINE SPARE PARTS

品号 PART NO.	页数 PAGE	行数 LINE	品号 PART NO.	页数 PAGE	行数 LINE	品号 PART NO.	页数 PAGE	行数 LINE	品号 PART NO.	页数 PAGE	行数 LINE
400-38754	P9	4-1	5			5222PF85641	P155	4-3	548936	P40	1-1
400-39364	P9	4-2	5000261	P31	4-7	5222PFL1400	P156	4-1	548992	P40	1-4
400-42378	P9	1-1	5000262	P31	4-8	5222PFL1480	P156	4-1	550449	P27	4-2
400-46301	P191	4-1	502670	P28	1-5	5222PFL1560	P156	4-2	5571677	P38	1-1
400-46302	P191	4-1	51009080	P7	3-6	5222PFL1640	P156	4-2	5582406	P38	3-5
400-46303	P191	4-1	5100912	P7	3-7	5222TP03400	P200	4-4	5582407	P38	3-5
400-46304	P191	4-1	52-275	P17	1-5	5222TP03480	P200	4-4	5582408	P38	3-5
400-46305	P191	4-1	52-288	P17	1-6	5222TP03640	P200	4-4	5582409	P38	3-5
400-46306	P191	4-1	520A007(1/4)	P212	4-6	5222TP11400	P200	3-5	5582410	P38	3-5
400-46314	P221	2-1	520A007(1/8)	P212	4-6	5222TP11480	P200	4-1	5582411	P38	3-5
400-46315	P221	2-1	520A007(3/16)	P212	4-6	5222TP11560	P200	4-1	5582412	P38	3-5
400-46316	P221	2-1	520A020	P34	3-4	5222TP13562	P200	3-3	5582413	P38	3-5
400-46317	P221	2-1	5210TP04A33	P199	3-4	5222TPL1400	P156	1-1	5582414	P38	3-5
400-46318	P221	2-1	5210TP04A43	P199	3-5	5222TPL1480	P156	1-1	5582551	P38	1-2
400-46319	P221	2-1	5210TP04A53	P199	4-1	5222TPL1560	P156	1-2	5582561	P38	1-3
400-50011	P126	2-1	5210TP04A63	P199	4-2	5222TPL1640	P156	1-2	5582562	P38	1-4
400-53705	P127	2-3	5210TP05C52	P200	1-2	5240PF0109	P17	4-2	5582562M	P38	1-5
400-71909	P127	3-4	5210TP45D53	P200	1-5	525C1-5-1	P61	2-3	5582563	P38	1-6
400-71911	P127	2-3	5210TPB3022A	P199	1-4	525C1-5-2	P61	2-4	5582564	P38	2-1
400-76709	P15	2-5	5212TP0015	P199	4-3	528C01-116(8")	P62	2-1	5582564M	P38	2-2
400-94773	P128	1-1	5212TP0033	P200	2-1	528C01-121(10")	P62	2-1	5589011	P7	4-1
400-94776	P126	3-3	5212TP0035	P200	1-1	540012	P67	1-1	559031310	P33	4-2
400-94776	P127	3-2	5220DF42562	P155	3-4	540741	P28	1-6	559032010	P33	4-1
400-94776	P126	3-2	5220DF85661	P155	3-3	540760	P28	1-7	56-304	P17	1-7
400-95289	P128	1-1	5220DF85661	P155	3-5	540760	P29	4-2	56-857	P16	3-3
400-95293	P126	3-3	5220FD42562	P155	2-4	542515-001T	P100	2-1	56-860	P16	3-2
400-95293	P127	3-2	5220FD85661	P155	2-3	544533	P28	1-3	5649-116-A0A	P12	4-8
400-95293	P126	3-2	5220FD85661	P155	2-5	544587	P40	2-3	568350050	P7	4-6
40015986	P14	2-2	5220FDL1561	P156	2-1	544588	P40	2-3	57-001	P137	1-3
40019884	P10	3-2	5220NC00400	P155	5-5	544589	P40	2-3	57-002	P137	1-6
40020224	P10	3-1	5220NC00400	P156	5-1	544593	P40	2-4	57-011	P137	1-2
40025949	P15	3-4	5220NC00480	P155	5-5	544595	P40	2-4	57-012	P138	1-2
40029004	P14	2-6	5220NC00480	P156	5-1	544596	P40	2-4	57-021	P137	1-2
40030932	P104	2-1	5220NC00561	P155	5-3	544599	P40	1-2	57-022	P138	1-1
40030933	P104	2-1	5220NC00561	P155	5-4	544600	P40	2-2	57-031	P137	1-3
40030934	P104	2-1	5220NC00561	P155	5-6	54782009	P51	1-5	57-032	P138	1-3
40034923	P14	1-1	5220NC00561	P156	5-2	548066	P40	2-1	57-041	P137	1-4
40044189	P12	1-1	5220NC00641	P155	5-3	548752	P40	3-2	57-042	P138	1-1
40044190	P12	1-3	5220NC00641	P155	5-4	548753	P40	3-2	57-051	P137	1-4
40050588	P12	1-4	5220NC00641	P155	5-6	548754	P40	3-2	57-052	P138	1-4
40050589	P12	1-2	5220NC00641	P156	5-2	548755	P40	3-2	57-061	P137	1-5
40089755	P11	4-1	5220PF42561	P155	4-4	548756	P40	3-2	57-071	P137	1-5
40719301	P15	4-2	5220PF42641	P155	4-4	548757	P40	3-2	57-1010-1	P137	3-3
40719302	P15	4-1	5220TP00564	P200	3-4	548758	P40	3-2	57-1020-1	P137	3-5
408-9101-01-B	P9	1-3	5220TP00566	P200	3-4	548759	P40	3-2	57-105	P137	3-3
408-9102-01-A	P6	4-2	5220TP00568	P200	3-2	548760	P40	3-2	57-105	P137	3-4
410295	P27	3-8	5220TP00646	P200	3-2	548761	P40	3-2	57-106	P137	3-3
411088	P28	1-4	5220TP003560	P200	4-4	548762	P40	3-1	57-107	P137	3-5
412585	P27	4-3	5220TP003563	P200	4-5	548763	P40	3-1	57-108	P137	3-5
412749	P27	3-7	5220TP42562	P156	1-4	548764	P40	3-1	57-108	P138	3-1
42305	P27	3-6	5220TP42642	P155	1-4	548765	P40	3-1	57-108	P138	3-2
42309	P27	3-5	5220TP85400	P155	1-5	548766	P40	3-1	57-108	P138	3-3
46-1001-5-289	P28	2-3	5220TP85480	P155	1-5	548767	P40	3-1	57-108	P138	3-5
46-1125-5-000	P28	2-4	5220TP85560	P155	1-3	548768	P40	3-1	57-1110-1	P137	3-2
46377	P43	2-3	5220TP85560	P155	1-6	548769	P40	3-1	57-1120-1	P138	3-3
47988	P53	1-5	5220TP85561	P155	1-3	548770	P40	3-1	57-1120-1	P138	3-5
4AG0030104	P17	4-7	5220TP85640	P155	1-6	548771	P40	3-1	57-115	P137	3-1
4AG0050103	P17	4-6	5220TP85641	P200	4-5	548804	P38	3-4	57-115	P137	3-2
4AG0050104	P17	3-7	5221TP60600	P200	4-3	548837	P40	2-5	57-116	P137	3-2
4C2-112	P62	1-1	52220DFL1561	P156	3-1	548838	P40	2-5	57-116	P137	3-4
4C2-113	P62	1-2	5222PF85400	P155	4-5	548845	P27	4-5	57-117	P138	3-3
4SS0330111	P18	2-3	5222PF85480	P155	4-5	548851	P27	4-6	57-117	P138	3-5
4SS0330115	P18	2-4	5222PF85560	P155	4-3	548865	P28	1-1	57-118	P138	3-4
4US0400121	P18	2-6	5222PF85560	P155	4-6	548886	P40	1-3	57-1210-1	P137	3-1
4US0400125	P18	2-5	5222PF85640	P155	4-6	548895	P40	1-5	57-1220-1	P138	3-4

品号 PART NO.	页数 PAGE	行数 LINE	品号 PART NO.	页数 PAGE	行数 LINE	品号 PART NO.	页数 PAGE	行数 LINE	品号 PART NO.	页数 PAGE	行数 LINE
57-126	P137	3-1	6031314C500	P17	4-3	6E	P59	1-1	801217	P55	1-2
57-127	P138	3-4	605340	P38	3-3	6EW	P60	1-1	801220	P53	1-7
57-1310-1	P137	3-4	613140	P35	1-1	6EW(KO)	P60	1-1	801222	P55	1-1
57-1320-1	P138	3-1	6200020	P31	3-1	6KM	P59	2-1	801227	P54	1-3
57-137	P138	3-1	6200022	P30	4-6	6KM(N)	P59	2-1	801268	P54	1-5
57-1420-1	P138	3-2	6200097	P30	1-8	6KMW	P60	2-1	801269	P55	1-4
57-147	P138	2-2	6200097	P30	2-7	6KMW(N)	P60	2-1	801274	P54	1-5
57-201	P137	2-2	6208000	P208	3-1	7			801345	P54	1-7
57-202	P137	2-3	6208002	P208	3-1	70(8)5A	P44	2-2	801420	P53	1-6
57-211	P137	2-1	625780	P7	4-3	716C 1-12	P61	4-1	801424	P53	1-8
57-212	P138	2-2	625790	P7	4-4	71CL 1 1/2(A)	P57	4-1	801437	P55	1-3
57-222	P138	2-3	627C1-10	P61	3-3	71CL 1 1/2(B)	P57	4-1	801438	P54	1-4
57-232	P138	2-1	62C6-31	P61	4-2	71CL 1 1/4(A)	P57	3-4	801439	P54	1-6
57-242	P138	2-4	63318	P182	4-1	71CL 1 1/4(B)	P57	3-4	802-1	P50	1-3
57-3010-1	P137	4-3	63318	P183	4-3	71CL 1 1/8(A)	P57	3-3	802-2	P50	1-4
57-310-1	P137	4-6	63319	P182	4-1	71CL 1 1/8(B)	P57	3-3	80C1-59	P42	1-1
57-3110-1	P137	4-2	63319	P183	4-3	71CL 1 3/8(A)	P57	3-5	80C1-61	P42	1-2
57-3120-1	P137	4-6	63320	P182	4-1	71CL 1 3/8(B)	P57	3-5	81000669	P34	4-6
57-3210-1	P137	4-1	63320	P183	4-3	71CL 1/2(A)	P57	1-5	81000670	P34	4-7
57-3220-1	P138	4-3	6378-113	P22	3-6	71CL 1/2(B)	P57	1-5	820C-1-7	P61	1-1
57-3310-1	P137	4-4	64041-N	P182	4-2	71CL 1/4(A)	P57	1-1	820C-1-8	P61	1-2
57-3320-1	P138	4-4	64041-N	P183	4-4	71CL 1/4(B)	P57	1-1	8330240201	P33	4-4
57-3410-1	P137	4-5	64042-N	P183	4-5	71CL 1/8(A)	P57	2-5	85878000	P51	1-7
57-3420-1	P138	4-1	643C1-42	P58	1-1	71CL 1/8(B)	P57	2-5	87C3-44	P61	3-4
57-3520-1	P138	4-2	643C1-43	P58	1-1	71CL 1(A)	P57	3-1	87C3-50	P61	3-1
57-3620-1	P138	4-5	643C1-47	P58	1-1	71CL 1(B)	P57	3-1	87C3-53	P61	3-6
57-503	P137	5-1	65(6)5A	P44	2-1	71CL 11/16(A)	P57	3-2	87C3-8	P61	3-2
57-504	P137	5-3	6500442	P110	1-1	71CL 11/16(B)	P57	3-2	87C6-13	P61	3-5
57-504	P138	5-1	6500443	P110	1-1	71CL 3/4(A)	P57	2-3	8C125-21	P42	1-3
57-505	P137	5-2	6500455	P110	1-1	71CL 3/4(B)	P57	2-3	8E	P59	1-1
57-506	P138	5-2	6500455	P31	4-2	71CL 3/8(A)	P57	1-3	8E(TFL)	P59	3-1
57-507	P138	5-3	6500456	P110	1-1	71CL 3/8(B)	P57	1-3	BEW	P60	1-1
570-974	P7	4-2	6500456	P31	4-3	71CL 5/16(A)	P57	1-2	BEW(KO)	P60	1-1
572303	P67	1-2	6500457	P110	1-1	71CL 5/16(B)	P57	1-2	8KM	P59	2-1
578 3283	P38	4-2	6500457	P31	4-4	71CL 5/8(A)	P57	2-2	8KMW	P60	2-1
578 3284	P38	4-2	6500458								



索引表
PARTS LIST

INDUSTRIAL SEWING MACHINE SPARE PARTS

索引表
PARTS LIST



INDUSTRIAL SEWING MACHINE SPARE PARTS

品号 PART NO.	页数 PAGE	行数 LINE	品号 PART NO.	页数 PAGE	行数 LINE	品号 PART NO.	页数 PAGE	行数 LINE	品号 PART NO.	页数 PAGE	行数 LINE
91-165505-05	P19	3-5	94210	P210	2-2	A-113(6)	P42	2-4	B1137-352-000	P191	4-3
91-168496-X5	P66	3-6	94211	P210	2-2	A-113(7)	P42	3-1	B1137-354-000	P191	4-4
91-168499-X5	P66	3-5	94212	P210	2-2	A-113(R)	P42	2-3	B1190-522-564	P191	2-3
91-188294-05	P19	2-4	94217	P182	4-4	A-90-3	P19	1-6	B1190-522-732	P191	2-1
91-188303-05	P19	2-5	94281	P210	2-1	A-90-7	P19	1-7	B1190-522-S00	P191	2-2
91-189140-05	P19	2-3	94283	P182	1-4	A105-21000	P35	2-3	B1190-522-T00	P191	2-2
91-263139-05	P19	4-1	94411	P31	3-8	A105-31000	P35	2-4	B1190-522-U00	P191	2-3
91-263294-05	P19	3-6	94417	P31	4-1	A141D676H01	P18	3-3	B1190-522-V00	P191	2-3
91-263348-05	P19	4-2	94800	P209	1-5	A4006-10H	P58	2-1	B1507-814-0A0	P136	4-6
91-264240-05	P19	3-3	94801	P182	1-6	A4006-11H	P58	2-1	B1509-038-B80	P128	3-5
91-264338-15	P19	3-2	94801	P183	1-5	A4006-12H	P58	2-1	B1509-038-C80	P129	3-5
91-500397-05	P19	4-3	94801-FS	P209	4-1	A4006-13H	P58	2-1	B1509-038-D80	P129	3-1
91-500399-05	P19	4-4	94801-L-DC[5.6]	P209	2-1	A4006-5H	P58	2-1	B1509-038-E80	P129	3-1
91-710004-04	P222	2-4	94801-L2	P209	3-1	A4006-6H	P58	2-1	B1509-038-F80	P129	3-2
91-710004-04/002	P222	2-3	94801-L2-05	P209	3-2	A4006-7H	P58	2-1	B1509-038-H80	P129	3-2
91-710004-04/005	P222	2-5	94801-LC	P209	3-3	A4006-8H	P58	2-1	B1509-038-K80	P129	3-3
91-710004-04/006	P222	2-6	94801-N	P209	4-1	A4142655000	P9	2-6	B1509-038-L8B	P129	3-3
911-1933-1	P50	2-1	94801-N-2	P209	4-1	A702	P26	3-7	B1525-241-HA0	P217	1-1
911-2933-2	P50	2-2	94801-N-5	P209	4-1	A703	P26	3-8	B1528-380-0A0	P14	2-4
91764	P210	3-2	94801B	P209	4-2	AB6110-0C	P33	4-3	B1528-804-000A	P9	4-5
91765	P210	3-2	94801C	P209	3-4	ABLE/HB-90-L	P34	4-4	B1530-352-000	P9	4-4
928530-2-00	P24	2-6	94801C-L5	P209	3-4	ABLE/HB-90-S	P34	4-5	B1552-781-000A	P218	3-1
928531-2-00	P24	2-5	94801D	P209	3-5	AC0516000000	P66	2-5	B1552-781-0A0-A	P218	4-1
929197-0-02	P24	2-4	94801D-L5	P209	3-5	AC0517000000	P66	2-6	B1552-782-000	P218	3-2
93170	P183	1-3	94802	P183	1-6	AC0518000000	P66	2-7	B1552-782-0A0-A	P218	4-2
93171	P183	1-3	94802-L5	P209	4-3	AF60874	P155	3-1	B1552-782-0A0-A(K)	P218	4-3
93172	P183	1-3	94901	P210	3-2	AF60875	P155	3-2	B1552-783-000	P218	3-4
93251	P223	4-5	94902	P184	1-2	AF702	P35	4-1	B1552-783-0A0-A	P218	4-4
93252	P223	4-5	94909	P184	4-2	AF703	P35	4-2	B1613-380-B00	P128	2-4
93253	P223	4-5	95-774464-25	P19	4-5	AN02	P24	4-6	B1613-380-C00	P128	2-4
93257	P223	4-6	95-774853-05	P19	4-7	AN12	P24	4-7	B1613-380-D00	P129	2-1
93351	P182	5-1	95-774855-05	P19	4-6	AN13	P24	4-8	B1613-380-F00	P129	2-2
93351	P183	5-3	95-774856-05	P19	4-8	AS-000288	P181	4-1	B1613-380-K00	P129	2-3
93351	P184	5-3	95085	P183	1-1	AS-001705	P181	4-1	B1623-180-000	P107	1-1
93352	P182	5-1	95085	P184	1-2	AS-002970	P181	4-2	B1656-804-000	P136	3-6
93352	P182	5-3	95089	P183	4-1	AS-003073	P181	4-2	B1657-804-000	P136	2-6
93352	P183	5-3	95234	P182	1-5	AS-003712	P181	4-3	B1657-804-00T	P130	2-3
93352	P184	5-1	95234	P184	1-1	AS-003713	P181	4-3	B1657-804-00T	P134	2-5
93352	P184	5-4	95238	P182	4-5	AT0204000000	P66	3-1	B1657-814-BOE	P131	2-3
93352	P185	5-5	95238	P184	4-1	AT020401	P67	3-2	B1657-814-BOE	P136	2-1
93353	P182	5-1	95260	P210	2-3	AT020402	P67	3-4	B1658-804-000	P136	3-6
93353	P183	5-3	95261	P210	2-4	AT1303000000	P67	4-2	B1812-210-D00	P111	2-1
93356	P184	5-5	95262	P210	2-4	AT1303010000	P67	4-3	B1812-980-0A0	P111	2-1
93356	P185	5-6	95276	P31	1-6	B			B1814-210-DA0	P111	2-1
93357	P182	5-2	95277	P30	2-5	B	P20	1-6	B1817-210-DAB	P111	2-1
93357	P183	5-5	95278	P210	4-3	B(HSS)	P20	1-6	B2001-761-0A0	P14	4-3
93357	P184	5-2	95279	P210	4-3	BOM-101(4)	P43	2-4	B2001-762-0A0	P14	4-4
93357	P184	5-6	95399	P31	3-8	BOM-80	P43	2-3	B2001-763-0A0	P14	4-5
93357	P185	5-2	95493	P183	1-4	B1-1	P50	2-1	B2001-771-0A0	P106	2-1
93357	P185	5-4	95580	P220	4-5	B1-2	P50	2-2	B2001-771-0A0	P14	4-6
93357	P186	5-1	95581	P220	4-5	B1103-380-B00	P128	1-4	B2015-372-0A0	P11	2-3
93357	P186	5-3	95582	P220	4-5	B1103-380-C00	P128	1-4	B2019-372-0A0	P11	2-2
93358	P183	5-4	95587	P182	4-6	B1103-380-D00	P129	1-1	B2401-761-0A0	P194	4-1
93358	P183	5-6	96-700535-05	P19	2-1	B1103-380-E00	P129	1-1	B2401-771-0A0	P106	2-1
93358	P184	5-2	96-700591-05	P19	2-2	B1103-380-F00	P129	1-2	B2401-771-080	P106	2-1
93358	P185	5-1	98089	P184	4-2	B1103-380-H00	P129	1-2	B2401-771-080	P194	4-2
93358	P185	5-3	981-886	P15	3-5	B1103-380-K00	P129	1-3	B2402-761-000	P193	1-2
93358	P185	5-4	981-888	P15	3-7	B1103-380-L00	P129	1-3	B2402-762-000	P193	1-2
93358	P186	5-2	981-889	P15	3-6	B1109-027-AA0	P193	4-4	B2402-771-000	P106	2-1
93394	P215	2-5	9E	P59	1-1	B1111038000	P193	4-3	B2402-771-000	P193	1-3
93395	P215	2-6	9EW	P60	1-1	B1130-026-000	P10	1-1	B2402-772-K00	P193	1-4
93396	P215	3-1	9EW(K0)	P60	1-1	B1131-026-000	P10	1-2	B2404-771-000	P106	2-1
93397	P215	3-1	9KM	P59	2-1	B1136-357-A00	P191	4-2	B2405-771-000	P106	2-1
93410	P209	1-4	9KMW	P60	2-1	B1136-357-B00	P191	4-2	B2406-373-0A0	P105	2-1
93417	P209	1-4	A			B1136-357-C00	P191	4-2	B2406-373-0A0	P106	1-1

品号 PART NO.	页数 PAGE	行数 LINE	品号 PART NO.	页数 PAGE	行数 LINE	品号 PART NO.	页数 PAGE	行数 LINE	品号 PART NO.	页数 PAGE	行数 LINE
B1406-019-FA0	P129	4-2	B2405-373-0A0	P11	1-3	B2421-280-0A0	P103	1-1	B2424-280-000	P103	1-1
B1406-019-HA0	P129	4-2	B2406-761-0A0	P14	3-3	B2421-280-0A0	P103	2-1	B2424-280-000	P103	2-1
B1406-019-KA0	P129	4-3	B2406-771-0A0	P106	2-1	B2421-280-0A0	P12	1-6	B2424-280-000	P12	1-7
B1406-019-LA0	P129	4-3	B2406-771-0A0	P14	3-4	B2421-280-0A0M	P12	2-1	B2424-280-000M	P12	2-2
B1409-890-GA0	P221	2-4	B2408-761-000	P14	3-2	B2423-280-00A	P101	2-1	B2425-210-000	P104	1-1
B1409-890-HA0	P221	2-5	B2408-771-000-A	P106	2-1	B2423-280-00A	P102	1-1	B2425-210-000	P194	1-1
B1420-714-B00	P136	6-5	B2408-771-000-A	P14	3-5	B2423-280-00A	P102	2-1	B2425-210-DAA	P104	1-1
B1420-716-D00	P221	2-3	B2410-373-000	P105	2-1	B2423-280-00A	P103	1-1	B2425-210-DAB	P104	1-1
B1507-814-0A0	P136	4-6	B2410-373-000	P106	1-1	B2423-280-00A	P103	2-1	B2425-215-P00	P105	1-1
B1509-038-B80	P128	3-5	B2410-373-000	P11	1-4	B2423-280-00A	P104	1-1	B2425-221-DAA	P105	1-1
B1509-038-C80	P129	3-5	B2414-280-000	P103	2-1	B2423-280-00A	P104	2-1	B2425-221-DAB	P105	1-1
B1509-038-D80	P129	3-1	B2414-280-0A0	P101	2-1	B2423-280-00A	P105	1-1	B2426-210-00A	P104	1-1
B1509-038-E80	P129	3-1	B2414-280-0A0	P102	1-1	B2423-280-00A	P106	1-1	B2426-210-00A	P104	2-1
B1509-038-F80	P129	3-2	B2414-280-0A0	P102	2-1	B2423-280-00A	P108	1-1	B2426-210-00A	P105	1-1
B1509-038-H80	P129	3-2	B2414-280-0A0	P103	1-1	B2423-280-00B	P101	2-1	B2426-210-00A	P193	2-4
B1509-038-K80	P129	3-3	B2414-280-0A0	P104	1-1	B2423-280-00B	P102	1-1	B2426-210-00B	P104	1-1
B1509-038-L8B	P129	3-3	B2414-280-0A0	P104	2-1	B2423-280-00B	P102	2-1	B2426-210-00B	P104	2-1
B1525-241-HA0	P217	1-1	B2414-280-0A0	P105	1-1	B2423-280-00B	P103	1-1	B2426-210-00B	P105	1-1
B1528-380-0A0	P14	2-4	B2415-280-000	P101	2-1	B2423-280-00B	P103	2-1	B2426-210-00B	P193	2-4
B1528-804-000A	P9	4-5	B2415-280-000	P102	1-1	B2423-280-00B	P104	1-1	B2426-210-00C	P193	2-4
B1530-352-000	P9	4-4	B2415-280-000	P102	2-1	B2423-280-00B	P104	2-1	B2426-210-00D	P193	2-4
B1552-781-000A	P218	3-1	B2415-280-000	P103	1-1	B2423-280-00B	P105	1-1	B2426-210-00F	P193	2-4
B1552-781-0A0-A	P218	4-1	B2416-210-000	P104	1-1	B2423-280-00B	P106	1-1	B2426-280-000	P101	2-1
B1552-782-000	P218	3-2	B2416-210-0A0	P104	2-1	B2423-280-00B	P106	2-1	B2426-280-000	P102	1-1
B1552-782-0A0-A	P218	4-2	B2416-210-0A0	P105	1-1	B2423-280-00C	P101	2-1	B2426-280-000	P193	2-5
B1552-782-0A0-A(K)	P218	4-3	B2416-210-DA0	P103	2-1	B2423-280-00C	P102	1-1	B2426-280-00B	P101	2-1
B1552-783-000	P218	3-4	B2416-280-000	P101	2-1	B2423-280-00C	P102	2-1	B2426-280-00C	P102	1-1
B1552-783-0A0-A	P218	4-4	B2416-280-000	P102	1-1	B2423-280-00C	P103	2-1	B2426-280-00C	P102	2-1
B1613-380-B00	P128	2-4	B2416-280-000	P102	2-1	B2423-280-00C	P103	2-1	B2426-280-00C	P193	2-5
B1613-											



索引表

PARTS LIST

INDUSTRIAL SEWING MACHINE SPARE PARTS

索引表

PARTS LIST

INDUSTRIAL SEWING MACHINE SPARE PARTS



品号 PART NO.	页数 PAGE	行数 LINE	品号 PART NO.	页数 PAGE	行数 LINE	品号 PART NO.	页数 PAGE	行数 LINE	品号 PART NO.	页数 PAGE	行数 LINE
CK-05G	P51	1-5	D2101R	P214	3-4	D9113	P179	2-2	E2627P	P206	1-3
CK-11T	P56	1-1	D2107	P175	3-2	D9117A	P180	2-1	E2826P	P206	1-4
CK-16L	P54	1-2	D2401-530-D00	P11	3-3	D912	P171	3-2	E2827P	P206	1-4
CK-17G	P51	1-6	D2402-415-BA0	P11	4-5	D9121	P180	2-2	E3024	P176	1-4
CK-17L	P54	1-1	D2402-555-BA0	P11	4-3	D9123A	P180	2-3	E3025	P176	1-4
CK-31L	P55	1-1	D2402-555-BAB	P11	4-4	D9313	P179	2-3	E3262	P174	2-5
CK-33G	P51	1-7	D2404-530-D00	P11	3-4	D9335-762-T00	P14	4-2	E3326	P177	1-3
CR26	P25	2-2	D2405-555-B00-B	P11	3-1	D969	P214	3-2	E3326P	P206	2-4
CR26H	P25	1-6	D2406-555-B00	P11	4-6	D971	P172	3-3	E3327	P177	1-3
CR26J	P25	1-5	D2406-555-D0H	P11	2-7	D972	P172	3-4	E3327P	P206	2-4
CR336	P24	3-2	D2406-555-D0H/M	P11	2-8	DF85209	P155	2-1	E3524P	P174	1-3
CRL03	P25	1-7	D2408-555-CA0	P12	3-2	DF86108	P155	2-2	E3524P	P175	1-4
CRL03H	P25	1-8	D2423-141-E00	P12	3-6	DSGK209F0617	P36	1-1	E3524R	P205	2-4
CRL03J	P25	2-1	D2424-141-E00	P12	3-7	DSGK6390616	P36	1-2	E3525P	P175	1-4
CRL04H	P25	2-6	D2426-282-C00	P102	2-1	DSK25	P34	4-3	E3525P	P205	1-3
CRL04J	P25	2-5	D2426-282-C00	P193	3-2	DSK27	P34	4-2	E3626P	P175	1-1
CRL09J	P24	3-1	D2426-284-M00	P103	2-1	DST-05	P8	2-8	E3627P	P206	1-5
CRL103	P25	2-3	D290	P171	3-2	DST-06	P8	2-7	E3727	P206	2-3
CRL104	P25	2-4	D3161-555-BA0	P12	3-5	DT05	P26	1-2	E3816P	P205	4-3
CRL204	P25	2-7	D3216	P174	3-2	DT06	P26	1-1	E3817P	P205	4-3
CT18-1	P25	4-4	D3216	P174	3-4	E					
CT19	P25	4-3	D3216	P175	3-5	E0215R	P206	4-1	E3826-H	P205	4-4
CT202	P25	4-6	D3216	P176	3-2	E0216R	P206	4-4	E3826P	P174	1-4
CT202295	P20	1-3	D3216	P176	3-4	E0217R	P206	4-4	E3826P	P175	1-5
CT203	P25	4-5	D3217	P176	3-4	E0225Q	P206	4-2	E3826R	P206	1-1
CT270-112	P23	3-6	D3222	P174	2-1	E0225R	P175	1-3	E3827	P176	1-2
CT270-113/1	P22	3-3	D390	P214	3-2	E0226P	P206	4-5	E3827P	P174	1-4
CT276B-112	P23	4-2	D4206	P174	3-3	E0226Q	P207	1-1	E3827P	P175	1-5
CT277-112	P24	1-1	D4206	P175	3-1	E0226R	P175	1-3	E3827R	P206	1-1
CT277-113	P22	4-1	D4206	P175	3-4	E0227Q	P207	1-1	E3836	P205	4-5
CT279-112	P23	4-3	D4206	P175	3-4	E0227R	P175	1-3	E3837	P205	4-5
CT290-112	P23	4-1	D4206	P176	3-1	E0235	P206	4-3	E3846	P176	1-1
CT290-113	P23	1-5	D4207	P174	3-3	E137	P207	2-5	E3847	P176	1-1
CT3100512	P31	3-6	D4207	P175	3-4	E137P	P207	3-1	E3966P	P207	1-2
CT37469	P30	4-4	D4207	P176	3-1	E138	P207	3-2	E3967	P207	1-3
CT39570	P29	2-7	D438	P171	3-1	E139	P207	3-3	E4124P	P174	1-5
CTMAS-11012	P10	3-2	D438	P171	3-2	E139P	P207	3-4	E4124P	P176	1-3
CTMAS-11013	P10	3-4	D440	P170	3-4	E140	P207	3-5	E4125P	P176	1-3
CV-40	P52	1-6	D440	P171	3-3	E141	P207	3-6	E4326	P206	2-5
D											
D095	P170	3-4	D440	P171	3-4	E1524	P177	1-1	E4326P	P175	1-6
D095	P171	3-4	D440	P171	3-5	E1525	P177	1-1	E4327	P206	2-5
D1206	P177	3-1	D489	P172	3-1	E1535	P205	2-1	E4327P	P206	2-5
D1207	P177	3-2	D490	P172	3-2	E1623	P206	1-2	E4426	P206	3-2
D1207	P177	3-4	D502	P172	3-1	E1816(3*5.6)	P205	3-4	E4426P	P174	1-2
D1215	P176	3-3	D502	P172	3-2	E1817(3*6.4)	P205	3-4	E4426P	P176	1-5
D1216	P177	3-3	D502	P172	3-3	E1826	P177	1-2	E4427	P206	3-2
D1506-772-K00	P116	3-3	D502	P172	3-4	E1826H(3*5.6)	P205	3-5	E4427P	P176	1-5
D1511-771-KA0	P218	2-3	D569	P171	3-1	E1827	P177	1-2	E4826	P177	1-4
D1511-771-KA0-A	P218	2-1	D574	P171	3-3	E1828	P177	1-5	E4836M	P205	2-3
D1511-772-KA0-A	P218	2-2	D574	P171	3-5	E1836L	P205	1-4	E5827	P206	2-1
D1511-773-KA0-A	P218	2-4	D575	P170	3-4	E1837	P205	4-1	E589F	P204	2-4
D1613-380-E00	P129	2-1	D575	P171	3-4	E1837L	P205	1-4	E590	P204	2-5
D1613-380-H00	P129	2-2	D581	P172	3-1	E1846	P205	4-2	E591B	P204	3-3
D1613-380-L00	P129	2-3	D582	P172	3-2	E1847	P205	4-2	E591E	P204	3-1
D1737	P28	3-1	D674	P171	3-1	E217	P173	1-3	E591F	P204	3-2
D2050-772-BA0-A-R14	P14	3-6	D674	P171	3-3	E218	P173	1-4	E6024	P206	3-1
D2052-772-B00	P14	3-7	D675	P171	3-5	E219	P173	1-5	E6326	P206	3-3
D2053-772-B00	P14	4-1	D675	P214	3-2	E222	P173	1-1	E6327	P206	3-3
D2056-772-B0B	P107	2-1	D8.15-11	P193	3-1	E229	P173	1-2	E6426	P206	3-4
D207	P173	3-1	D9012	P178	2-2	E232	P205	1-2	E6426P	P206	3-4
D207	P173	3-2	D9012	P179	2-1	E2324P	P205	1-5	E6426R	P174	1-1
D208	P173	3-2	D9104	P178	2-1	E2325P	P205	1-5	E6427P	P206	3-5
D210	P173	3-1	D9108	P178	2-3	E2326P	P205	2-2	E6427R	P174	1-1
D2101	P175	2-3	D9112	P178	2-2	E2625P	P205	3-3	E6628	P206	2-2
			D9112	P179	2-1	E2626P	P175	1-2	E705	P207	1-4

品号 PART NO.	页数 PAGE	行数 LINE	品号 PART NO.	页数 PAGE	行数 LINE	品号 PART NO.	页数 PAGE	行数 LINE	品号 PART NO.	页数 PAGE	行数 LINE
E705P	P207	1-4	ERK35	P33	1-6	E705T	P207	1-5	GP-010014-00	P27	1-2
E705Q	P207	1-4	EY6121-0A	P33	4-6	E783	P171	1-1	GP-010017-00	P27	1-1
E705R	P207	1-4	EY6122-0A	P33	4-5	E784	P171	1-1	GP-010244	P181	1-2
E705S	P207	1-5	F								
GP-010014-00	P211	2-1	FB05 4.0	P211	2-1	E790	P207	2-1	GP-010244	P211	4-1
GP-010017-00	P211	2-1	FB05 4.8	P211	2-1	E791	P207	2-2	GP-012179	P181	3-3
GP-010244	P181	1-2	FB05 5.6	P211	2-2	E793	P207	2-3	GP-012180	P181	2-3
GP-010244	P211	4-1	FB05 6.6	P211	2-2	E794	P207	2-4	GP-012184	P181	1-3
GP-012179	P181	3-3	FB15	P28	2-7	E796	P204	2-1	GP-012185	P181	1-3
GP-012180	P181	2-3	FB356-2N	P211	2-3	E797	P204	2-1	GP-012186	P181	2-3
GP-012184	P181	1-3	FBQ30	P24	3-5	E800	P170	1-4	GP-012985	P181	3-3
GP-012185	P181	1-3	FC240	P221	3-3	E800C	P204	2-2	GP-013516	P223	1-3
GP-012186	P181	2-3	FC248	P221	3-3	E800D	P204	2-3	GP-021183-00	P211	4-2
GP-012985	P181	3-3	FC366	P221	3-4	E804	P204	3-4	GP-025666-06	P68	1-2
GP-013516	P223	1-3	FC364	P221	3-4	E804A	P204	3-4	GP-030272	P223	1-5
GP-021183-00	P211	4-2	FD60828	P155	3-1	E805	P171	1-5	GP-031183-00	P223	1-1
GP-025666-06	P68	1-2	FD60842	P155	3-2	E805A	P204	3-4	GP-032603	P223	1-4
GP-030272	P223	1-5	FD634D03	P155	3-2	E809	P171	1-4	GP-032604	P223	1-4
GP-031183-00	P223	1-1	FE224	P143	2-2	E809	P171	1-5	GP-032605	P223	1-4
GP-032603	P223	1-4	FE244	P142	2-3	E809A	P204	3-5	GP-032606	P223	1-4
GP-032604	P223	1-4	FE245	P145	2-2	E810	P171	1-4	GTP605D53	P200	2-2
GP-032605	P223	1-4	FE246	P129	2-4	E810A	P204	4-1	GTP605D63	P200	2-2
GP-032606	P223	1-4	FE247	P129	2-4	E810L	P204	4-2	H		
GTP605D53	P200	2-2	FE248	P129	2-6	E8148P	P205	2-5	H00G'S110(4)	P42	2-2
GTP605D63	P200	2-2	FEC02	P26	4-4	E839	P204	4-3	H1258	P77	2-1
J											
JK-T580-01-28-018P40	4-1		FEC03	P26	4-3	E868	P172	1-3	H1259	P177	2-2
JK-T580-01-28-017P40	4-2		FR134	P25	1-3	E870	P204	4-4	H1259	P177	2-5
JK-T580-01-28-018P40	4-3		FR34	P25	1-2	E871	P204	4-5	H1261	P176	2-4
JP-01	P69	1-2	FR34B	P25	1-1	E871C	P205	1-1	H1262	P177	2-3
JP-02	P69	1-1	FR34H	P25	1-4	E8801	P205	3-1	H1359	P177	2-4
JP-03	P69	2-2	FR40	P24	3-6	E8811	P205	3-2	H204	P173	2-1
JP-04	P69	2-1	FR40D	P24	3-7	E8821	P205	3-2	H208	P173	2-2
JP-07	P90	4-1	FR40J	P24	4-1	E9012	P178	1-2	H209	P173	2-3
JP-07-2	P90	4-2	FR40K	P24	3-8	E9012	P179	1-1	H2203R	P175	3-3
JP-100-2	P77	3-3	FV08	P26	1-3	E9104D	P178	1-1	H2203R	P214	3-3
JP-100-2	P77	3-1	FX0205010000	P66	1-3	E9108	P178	1-3	JP-112-2	P76	4-4
JP-101-1	P81	2-2	FX0206010000	P66	1-1	E9112	P178	1-2	JP-115	P91	2-6
JP-103-2	P69	4-3	FX0206010000[D]G	P66	2-1	E9113	P179	1-1	JP-105-2	P72	1-4
JP-105-2	P72	2-4	FX0207010000	P66	1-2	E9117A	P180	1-1	JP-107-2	P93	3-2
JP-107-2	P93	3-5	FX0207010000[D]G	P66	2-2	E9121	P180	1-2	JP-108-2	P76	4-5
JP-108-2	P76	4-5	FX0219000000	P66	2-4	E9123A	P180	1-3	JP-112-2	P76	4-4
JP-112-2	P76	4-4	FX0221000000	P66	2-3	E919	P171	1-3	JP-115	P91	2-6
JP-115	P91	2-6	FX0227000000	P66	1-4	E919A</					



索引表 PARTS LIST

INDUSTRIAL SEWING MACHINE SPARE PARTS

索引表 PARTS LIST



INDUSTRIAL SEWING MACHINE SPARE PARTS

品号 PART NO.	页数 PAGE	行数 LINE	品号 PART NO.	页数 PAGE	行数 LINE	品号 PART NO.	页数 PAGE	行数 LINE	品号 PART NO.	页数 PAGE	行数 LINE
JP-150	P71	1-4	JP-238-2	P87	4-2	JP-330	P70	1-5	JP-407	P88	4-1
JP-150-2	P71	2-4	JP-239	P91	4-4	JP-330-2	P70	2-5	JP-407-2	P88	4-2
JP-152	P86	3-1	JP-239-2	P91	4-3	JP-331	P70	1-4	JP-408	P73	3-5
JP-154	P91	4-1	JP-24	P90	3-1	JP-331-2	P70	2-4	JP-408-2	P73	4-5
JP-154-2	P91	4-2	JP-242	P93	1-6	JP-333	P74	3-3	JP-413	P74	3-4
JP-155	P79	3-3	JP-242-2	P93	1-5	JP-333-2	P74	4-3	JP-413-2	P74	4-4
JP-155-2	P79	4-3	JP-245	P80	2-4	JP-334	P83	1-1	JP-416-2	P86	3-3
JP-156	P79	3-1	JP-245-2	P80	3-4	JP-334-2	P83	1-2	JP-42	P69	3-4
JP-156-2	P79	4-1	JP-253	P83	1-3	JP-335	P88	2-2	JP-424	P76	3-1
JP-157	P79	3-4	JP-253-2	P83	1-4	JP-335-2	P88	2-1	JP-424-2	P76	4-1
JP-157	P79	4-4	JP-254	P87	2-2	JP-34	P90	4-5	JP-428	P92	2-6
JP-169	P93	2-5	JP-254-2	P87	2-1	JP-341	P80	2-2	JP-428-2	P92	2-5
JP-177	P70	1-1	JP-257	P83	4-1	JP-341-2	P80	3-2	JP-434	P82	1-1
JP-178	P70	2-1	JP-257-2	P83	4-2	JP-343	P75	4-5	JP-434-2	P82	1-2
JP-181	P78	4-2	JP-258	P87	1-3	JP-344	P75	4-4	JP-439	P93	3-3
JP-182	P78	4-1	JP-259	P83	3-2	JP-35	P90	4-6	JP-441	P92	3-2
JP-188	P91	2-4	JP-259-2	P83	3-1	JP-355	P86	2-2	JP-441-2	P92	3-1
JP-188-2	P91	2-3	JP-260	P77	1-5	JP-355-2	P86	2-1	JP-446	P78	1-2
JP-192	P93	2-6	JP-260-2	P77	2-5	JP-356	P81	3-1	JP-446-2	P78	1-4
JP-193	P72	1-5	JP-261	P77	1-4	JP-356-2	P81	3-2	JP-447	P82	1-3
JP-194	P72	2-5	JP-261-2	P77	2-4	JP-357	P81	3-3	JP-447-2	P82	1-4
JP-195	P89	1-2	JP-262	P89	2-2	JP-357-2	P81	3-4	JP-456	P84	3-1
JP-195-2	P89	1-1	JP-262-2	P89	2-1	JP-36	P86	4-1	JP-456-2	P84	3-2
JP-20	P91	4-5	JP-266	P80	2-3	JP-36-2	P86	4-2	JP-46	P91	1-1
JP-201	P70	3-2	JP-266-2	P80	3-3	JP-361	P87	3-2	JP-46-2	P91	1-2
JP-201-2	P70	4-2	JP-267	P90	3-2	JP-361-2	P87	3-1	JP-462	P83	2-1
JP-202	P70	3-1	JP-269	P92	1-4	JP-362	P70	1-2	JP-462-2	P83	2-2
JP-202-2	P70	4-1	JP-269-2	P92	1-3	JP-362-2	P70	2-2	JP-463	P78	2-2
JP-204	P84	2-1	JP-274	P72	3-2	JP-363	P70	1-3	JP-463-2	P78	3-4
JP-204-2	P84	2-2	JP-274-2	P72	4-2	JP-363-2	P70	2-3	JP-464	P78	3-1
JP-206	P73	1-3	JP-28	P75	4-1	JP-364	P80	1-1	JP-464-2	P78	3-3
JP-206	P74	1-3	JP-284	P74	3-1	JP-364-2	P80	1-3	JP-465	P81	4-1
JP-206	P76	1-3	JP-284-2	P74	4-1	JP-366	P76	3-2	JP-465-2	P81	4-2
JP-206	P76	3-3	JP-285	P74	3-2	JP-366-2	P76	4-2	JP-466	P84	3-3
JP-206-2	P73	2-3	JP-285-2	P74	4-2	JP-373	P84	4-1	JP-466-2	P84	3-4
JP-206-2	P74	2-3	JP-29	P75	4-3	JP-373-2	P84	4-2	JP-467	P83	4-3
JP-206-2	P76	2-3	JP-293	P79	1-3	JP-378	P83	3-3	JP-467-2	P83	4-4
JP-206-2	P76	4-3	JP-293-2	P79	2-3	JP-378-2	P83	3-4	JP-468	P84	1-3
JP-21	P91	4-6	JP-294-2	P79	1-4	JP-381	P80	1-2	JP-468-2	P84	1-4
JP-210	P86	2-3	JP-294-2	P79	2-4	JP-381-2	P80	1-4	JP-469	P92	3-6
JP-210-2	P86	2-4	JP-295	P90	3-3	JP-382	P79	3-2	JP-469-2	P92	3-5
JP-211	P71	2-2	JP-30	P75	4-2	JP-382-2	P79	4-2	JP-47	P78	2-2
JP-211-2	P71	1-2	JP-301	P70	3-3	JP-383	P82	4-3	JP-47-2	P78	2-4
JP-214	P77	1-2	JP-301-2	P70	4-3	JP-383-2	P82	4-4	JP-470	P92	4-2
JP-214-2	P77	2-2	JP-302	P88	1-2	JP-385	P89	3-2	JP-470-2	P92	4-1
JP-219	P92	1-1	JP-302-2	P88	1-1	JP-385-2	P89	3-1	JP-472	P93	3-4
JP-219-2	P92	1-2	JP-303	P81	4-3	JP-387	P92	2-4	JP-474	P75	1-3
JP-220	P79	2-1	JP-303-2	P81	4-4	JP-387-2	P92	2-3	JP-474	P92	3-4
JP-220-2	P79	1-1	JP-306	P72	2-2	JP-394	P80	2-1	JP-474-2	P75	2-3
JP-221	P79	2-2	JP-306-2	P72	1-2	JP-394-2	P80	3-1	JP-474-2	P92	3-3
JP-221-2	P79	1-2	JP-307	P72	1-1	JP-397	P84	1-1	JP-48	P78	2-1
JP-225	P93	2-2	JP-307-2	P72	2-1	JP-397-2	P84	1-2	JP-48-2	P78	2-3
JP-225-2	P93	2-1	JP-31	P90	2-5	JP-398	P78	1-1	JP-483	P72	3-5
JP-226	P72	1-3	JP-310	P92	1-6	JP-398-2	P78	1-3	JP-483-2	P72	4-5
JP-226-2	P72	2-3	JP-310-2	P92	1-5	JP-401	P87	1-2	JP-484	P85	2-1
JP-229	P76	1-5	JP-311	P90	3-4	JP-402	P71	3-3	JP-484-2	P85	2-2
JP-229-2	P76	2-5	JP-312	P86	3-2	JP-402-2	P71	4-3	JP-486	P77	1-1
JP-23	P93	4-1	JP-313	P82	3-1	JP-403	P71	3-1	JP-486-2	P77	2-1
JP-230	P76	1-4	JP-313-2	P82	3-2	JP-403-2	P71	4-1	JP-49	P69	1-3
JP-230-2	P76	2-4	JP-314	P90	1-3	JP-404	P71	3-2	JP-494	P84	4-3
JP-236	P70	3-4	JP-314-2	P90	1-4	JP-404-2	P71	4-2	JP-494-2	P84	4-4
JP-236-2	P70	4-4	JP-323	P90	2-3	JP-405	P73	3-4	JP-495	P72	3-4
JP-237	P70	3-5	JP-323-2	P90	2-4	JP-405-2	P73	4-4	JP-495-2	P72	4-4
JP-237-2	P70	4-5	JP-325	P92	2-2	JP-406	P84	2-3	JP-496	P93	2-4
JP-238	P87	4-1	JP-325-2	P92	2-1	JP-406-2	P84	2-4	JP-496-2	P93	2-3

品号 PART NO.	页数 PAGE	行数 LINE	品号 PART NO.	页数 PAGE	行数 LINE	品号 PART NO.	页数 PAGE	行数 LINE	品号 PART NO.	页数 PAGE	行数 LINE
JP-50	P69	2-3	JP-608-2	P75	2-2	JP-507	P83	2-3	JP-621	P82	4-1
JP-501	P90	3-5	JP-609	P85	1-3	JP-507-2	P83	2-4	JP-621-2	P82	4-2
JP-502	P80	4-1	JP-609-2	P85	1-4	JP-512	P87	1-1	JP-63	P78	4-4
JP-503	P80	4-2	JP-611-2	P75	3-4	JP-513	P89	4-1	JP-630	P74	1-1
JP-504	P85	4-3	JP-612-2	P75	3-5	JP-513-2	P89	4-2	JP-630-2	P74	2-1
JP-504-2	P85	4-4	JP-62	P78	4-3	JP-516-2	P85	4-2	JP-631	P74	1-2
JP-506	P73	1-1	JP-620	P73	2-2	JP-517	P72	3-1	JP-631-2	P74	2-2
JP-506-2	P73	2-1	JP-620-2	P73	1-2	JP-517-2	P72	4-1	JP-636	P73	3-3
JP-507	P83	2-3	JP-621	P82	4-1	JP-534	P75	1-4	JP-636-2	P73	4-3
JP-507-2	P83	2-4	JP-621-2	P82	4-2	JP-534-2	P75	2-4	JP-637	P73	3-1
JP-512	P87	1-1	JP-63	P78	4-4	JP-535	P74	1-5	JP-637-2	P73	4-1
JP-513	P89	4-1	JP-630	P74	1-1	JP-535-2	P74	2-5	JP-638	P73	3-2
JP-513-2	P89	4-2	JP-630-2	P74	2-1	JP-536	P82	3-3	JP-638-2	P73	4-2
JP-516-2	P85	4-2	JP-631	P74	1-2	JP-536-2	P82	3-4	JP-641	P92	4-6
JP-517	P72	3-1	JP-631-2	P74	2-2	JP-537	P92	4-4	JP-641-2	P92	4-5
JP-517-2	P72	4-1	JP-636	P73	3-3	JP-537-2	P92	4-3	JP-642	P90	1-1
JP-534	P75	1-4	JP-636-2	P73	4-3	JP-538-2	P87	1-4	JP-649	P90	1-2
JP-534-2	P75	2-4	JP-637	P73	3-1	JP-544	P75	1-5	JP-658	P93	1-2
JP-535	P74	1-5	JP-637-2	P73	4-1	JP-544-2	P75	2-5	JP-658-2	P93	1-1
JP-535-2	P74	2-5	JP-638	P73	3-2	JP-545	P74	1-4	JP-661	P90	2-1
JP-536	P82	3-3	JP-638-2	P73	4-2	JP-545-2	P74	2-4	JP-661-2	P90	2-2
JP-536-2	P82	3-4	JP-641	P92	4-6	JP-546	P76	1-2	JP-68	P69	4-1
JP-537	P92	4-4	KE1033	P45	2-3	JP-546-2	P76	2-2	JP-69	P69	3-1
JP-537-2	P92	4-3	KE1057	P32	3-7	JP-547	P76	1-1	JP-70	P69	3-2
JP-538-2	P87	1-4	KE109	P35	1-4	JP-547-2	P76	2-1	JP-71	P69	4-2
JP-544	P75	1-5	KE124	P68	4-1	JP-547-2	P76	2-1	JP-723	P93	1-4
JP-544-2	P75	2-5	KE134	P68	4-2	JP-554-2	P75	3-1	JP-723-2	P93	1-3
JP-545	P74	1-4	KE148(B)	P48	1-2	JP-555-2	P75	3-2	JP-757	P74	3-5
JP-545-2	P74	2-4	KE149(B)	P42	1-3	JP-556	P85	3-1	JP-757-2	P74	4-5
JP-546	P76	1-2	KE168	P34	1-5	JP-556-2	P85	3-2	JP-76	P91	1-4
JP-546-2	P76	2-2	KE172(B)	P46	2-2	JP-557	P73	1-5	JP-76-2	P91	1-3
JP-547	P76	1-1	KE189	P56	1-6	JP-557-2	P73	2-5	JP-77	P93	3-1
JP-547-2	P76	2-1	KE242	P47	1-3	JP-558-2	P73	2-4	JP-78	P91	1-5
JP-547-2	P76	3-1	KE263	P55	1-5	JP-560	P85	2-3	JP-78-2	P91	1-6
JP-554-2	P75	3-1	KE264	P36	2-2	JP-560-2	P85	2-4	JP-79	P71	3-5
JP-555-2	P75	3-2	KE285	P36	2-1	JP-561-2	P90	1-5	JP-79-2	P71	4-5
JP-556	P85	3-1	KE286	P56	1-5	JP-564	P81	1-1	JP-80	P91	2-2
JP-556-2	P85	3-2	KE288(B)	P47	1-2	JP-564-2	P81	1-3	JP-80-2	P91	2-1
JP-557	P73	1-5	KE272	P47	3-1	JP-565	P81	1-2	JP-83	P69	1-4
JP-557-2	P73	2-5	KE273(B)	P48	1-1	JP-565-2	P81	1-4	JP-83-2	P69	2-4
JP-558	P73	1-4	KE277	P56	1-3	JP-566	P88	3-1	JP-84	P77	3-4
JP-558-2	P73	2-4	KE278	P32	4-1	JP-566-2	P88	3-2	JP-84-2	P77	3-2
JP-560	P85	2-3	KE287	P32	4-2	JP-567	P85	3-3	JP-85	P69	1-5
JP-560-2	P85	2-4	KE291(B)	P48	1-3	JP-567-2	P85	3-4	JP-85-2		



索引表 PARTS LIST

INDUSTRIAL SEWING MACHINE SPARE PARTS

索引表 PARTS LIST



INDUSTRIAL SEWING MACHINE SPARE PARTS

品号 PART NO.	页数 PAGE	行数 LINE	品号 PART NO.	页数 PAGE	行数 LINE	品号 PART NO.	页数 PAGE	行数 LINE	品号 PART NO.	页数 PAGE	行数 LINE
K556	P170	4-5	M5248	P175	5-2	MJ-03	P68	3-1	P103/F374	P219	3-4
K556	P171	4-1	M5248	P175	5-3	MJ-04	P68	2-4	P12-41	P214	1-4
K556	P171	4-2	M5248	P176	5-2	MJ-05	P68	3-2	P12-42	P214	1-5
K556	P171	4-3	M5348	P222	3-4	MK-5D	P46	1-3	P14-18	P211	3-2
K556	P171	4-4	M5356	P174	5-1	MK-90H	P47	1-1	P1406	P175	4-1
K556	P171	4-5	M5356	P175	5-2	MP41A0838	P18	4-3	P1406	P177	4-4
K556	P219	2-5	M5356	P175	5-4	MP41B0838	P18	4-2	P152D-3	P171	4-1
L			M5356	P175	5-5	MS-101062-1	P32	3-4	P152D-A	P171	4-2
L9012	P178	5-2	M5356	P176	5-1	MS-101069	P32	3-3	P152D/F155	P171	4-1
L9012	P179	5-1	M5356	P176	5-3	MS01A0121	P112	1-1	P152D/F525	P171	4-2
L9104	P178	5-1	M5364	P174	5-1	MS01A0472	P109	1-1	P16-26	P28	3-4
L9112	P178	5-2	M5364	P175	5-2	MS01A0611	P112	1-1	P16-9	P28	3-3
L9112	P178	5-3	M5364	P175	5-4	MS01A1476	P109	1-1	P17-22	P28	3-6
L9112	P179	5-1	M5364	P176	5-1	MS02A1-101	P211	1-4	P17-35	P28	3-5
L9117	P180	5-1	M5364	P176	5-3	MS03A0838	P109	1-1	P1813-A	P219	4-1
L9119T-E	P179	5-2	M9012	P178	4-2	MS03A0838	P18	4-5	P9123-A	P174	4-5
L9121	P180	5-2	M9012	P179	4-1	MS03A0838/M	P18	4-5	P1814	P176	4-3
L9123	P180	5-3	M90605010	P109	1-1	MS03A1-101	P109	1-1	P1815	P176	4-3
L9313	P179	5-3	M90906003	P109	1-1	MS03A1-101	P211	1-3	P201-4A	P173	4-1
LECTRA 715	P32	4-4	M9104	P178	4-1	MS03B0838	P109	1-1	P201-4A	P219	2-1
LK-1850	P101	2-1	M9108	P178	4-3	MS03B0838	P18	4-4	P201-A	P173	4-1
LK-1900	P102	1-1	M9112	P178	4-2	MS03B0838/M	P18	4-4	P203-A	P219	2-3
LK-1900A	P102	2-1	M9112	P179	4-1	MS07A0180	P18	4-1	P211-A	P219	2-2
LK1910/LK1920	P103	2-1	M91129015	P109	1-1	MS07A0782	P18	3-6	P216	P174	4-2
LR21	P25	3-1	M9113	P179	4-2	MS08A0616	P112	1-1	P2116-A	P176	4-4
LU02	P26	1-6	M9117	P180	4-1	MS14A0472	P211	1-2	P2116-A	P177	4-3
LU04	P26	2-1	M9121	P180	4-2	N			P2117-A	P176	4-4
LU05	P26	1-7	M9123	P180	4-3	N09.002S101	P52	1-5	P2117-A	P177	4-3
LU101	P26	2-4	M9313	P179	4-3	NAVALHA GP1	P33	1-5	P212A-5A	P219	4-4
LU103	P26	2-5	M96004052	P109	1-1	NC603033	P221	3-1	P212A-A	P219	2-4
LU501	P26	2-6	MA10B2476	P109	1-1	NC604022	P221	3-2	P217-4	P219	3-2
LU503	P26	2-7	MAS-11012	P10	3-5	NC605032	P155	5-1	P2314-A	P219	4-2
LU602	P26	2-2	MAS-11013	P10	3-6	NC605048	P155	5-2	P2315-A	P220	1-1
LU605	P26	2-3	MAS-11016	P10	4-1	NE041	P198	2-5	P233-A	P172	4-4
LX-045	P196	3-5	MAS-11017	P10	4-2	NE042	P198	3-1	P233-A	P173	4-4
M			MAT-00504000-A	P10	2-6	NE333	P143	1-2	P2408	P177	4-5
M-048	P62	3-3	MAT-0050500	P10	2-5	NE373	P142	1-3	P2416	P172	4-6
M-049	P62	3-4	MAT-02203000	P10	1-4	NE374	P145	1-2	P2416	P174	4-6
M-050	P62	3-2	MAT-02204000	P10	1-5	NE387	P129	1-4	P2416	P175	4-5
M-051	P62	3-5	MAT-03505000	P10	1-7	NE388	P129	1-4	P2436-A	P220	1-2
M-085.L10(10°)	P62	4-3	MAT-03506000	P10	1-6	NE389	P129	1-6	P2438Q-A	P220	1-3
M-085.L8(8°)	P62	4-3	MAT-0360500A	P10	2-2	NP-2103000-00	P107	2-1	P2446-A	P176	4-2
M-169	P62	4-1	MAT-03606000	P10	2-1	P			P2447-A	P176	4-2
M-170	P62	4-2	MAT04302000	P10	2-4	P0024	P174	4-3	P2457-A	P220	1-4
M0700(6)	P43	3-2	MAT04303000	P10	2-3	P0024	P175	4-3	P253E-3	P170	4-4
M0702	P43	3-1	MAZ-15501000	P193	3-4	P0024	P177	4-1	P253E-4	P171	4-3
M0703(8)	P43	3-3	MAZ-15601000	P103	1-1	P0025	P175	4-3	P253E-5	P219	3-1
M4232	P222	3-1	MAZ-15601000	P193	3-6	P0025	P177	4-1	P253E/F371	P170	4-4
M4240	P174	5-3	MAZ-15601000	P103	1-1	P0216	P174	4-4	P253E/F374	P171	4-3
M4240	P174	5-5	MAZ-15801000	P193	3-5	P0216	P175	4-4	P253E/F525	P219	3-1
M4240	P177	5-1	MB62A1470	P211	1-1	P0216	P177	4-2	P2544-A	P220	1-6
M4248	P177	5-1	MF00A0834	P18	3-1	P0217	P174	4-4	P2545-A	P220	2-1
M4348	P222	3-3	MF00A0838	P18	3-2	P0217	P175	4-4	P254G-4	P171	4-5
M4356	P174	5-2	MF02A0834	P18	3-4	P0217	P177	4-2	P254G/F504G	P171	4-5
M4356	P174	5-4	MF02A0834/M	P18	3-4	P0226	P176	4-1	P255-A	P172	4-5
M4356	P174	5-6	MF02A0838	P18	3-5	P0227	P176	4-1	P2785-A	P175	4-2
M4356	P175	5-1	MF02A0838/M	P18	3-5	P0314-A	P219	4-3	P2786-A	P175	4-2
M4356	P177	5-2	MF90A0838	P18	4-7	P0416-A	P220	1-5	P2787-A	P175	4-2
M4356	P177	5-3	MF90B0838	P18	4-6	P101-3	P170	4-5	P3816R-A	P174	4-1
M4364	P174	5-4	MG52A0834	P18	3-7	P101-4	P171	4-4	P3816R-A	P219	4-5
M4364	P177	5-2	MG52A0838	P18	3-8	P101/F371	P170	4-5	P3817-A	P219	4-5
M4460	P177	5-4	MJ-01	P68	2-2	P101/F374	P171	4-4	P3817R-A	P174	4-1
M5232	P222	3-2	MJ-01[4]	P68	2-3	P103-3	P219	2-5	P502	P172	4-2
M5240	P175	5-3	MJ-01[9]	P68	2-1	P103-4	P219	3-4	P502J-A	P173	4-3
M5240	P176	5-2	MJ-02	P68	2-5	P103/F371	P219	2-5	P504	P172	4-1

品号 PART NO.	页数 PAGE	行数 LINE	品号 PART NO.	页数 PAGE	行数 LINE	品号 PART NO.	页数 PAGE	行数 LINE	品号 PART NO.	页数 PAGE	行数 LINE
P504J-A	P173	4-2	R4205-H0D-E00	P131	1-3	R4612-LOF-L00	P191	1-5	S02637-001	P3	2-4
P5232K-A	P220	2-2	R4205-H0D-EA0	P131	1-4	R4612-LOH-G00	P134	1-3	S02637-001/M	P3	2-5
P7-11	P211	3-1	R4205-J0E-E00	P192	2-3	R4612-LOH-L00	P191	1-3	S02643-001	P3	2-6
P7-11 4.0	P211	2-5	R4205-J0E-E00	P136	1-1	R4612-LOH-L00	P134	1-3	S02645-001	P3	2-1
P7-7(5.6)	P221	3-5	R4253-F0H-G0P	P193	2-1	R4612-LOH-L00	P191	1-3	S02645-001(H)	P3	2-1
P8-50	P28	3-7	R4254-F0H-G0B	P193	2-2	R4E	P42	1-1	S02645-001/M	P3	2-2
P8003-A	P220	2-3	R4300-E0F-E00	P192	1-1	R4KM(8)	P42	3-3	S02646-001	P3	2-3
P8104-A	P220	2-4	R4300-H0D-E00	P131	1-1	R5 1/4E	P42	1-2	S02646-001(H)	P3	2-3
P9012D-A	P179	3-1	R4300-J0E-E00	P192	1-5	R5KM	P43	1-2	S03567-001	P6	1-5
P9104	P178	3-1	R4300-L0E-E00	P192	1-3	R6KM	P43	1-3	S03627-001	P6	1-3
P9108-A	P178	3-3	R4300-L0F-E00	P132	1-4	R9012	P178	6-2	S03629-001	P6	1-4
P9112D-A	P179	3-1	R4305-E0D-E00	P192	2-1	R9012	P179	6-1	S05946-101	P122	1-1
P9113D-A	P179	3-2	R4305-E0D-E0A	P192	2-1	R9104	P178	6-1	S06310-001	P122	5-1
P9117-A	P180	3-1	R4305-H0D-E00	P131	1-2	R9112	P178	6-2	S07525-000	P2	4-4
P9121-A	P180	3-2	R4305-H0E-E00	P130	1-2	R9112	P179	6-1	S07526-001	P2	4-6
P9123-A	P180	3-3	R4305-H0F-E00	P192	2-2	R9113	P179	6-2	S07526-201	P2	4-7
P9313-A	P179	3-3	R4305-J0D-E00	P192	2-4	R9117	P180	6-1	S07526-301	P3	1-1
P9412D-A	P178	3-2	R4305-J0D-E00(摩吉)	P192	2-4	R9121	P180	6-2	S07526-301[TT]	P3	1-2
P9512D-A	P178	3-2	R4305-J0E-E00	P134	1-6	R9123	P180	6-3	S07527-001	P2	4-5
P955	P172	4-3	R4305-J0E-E00(摩吉)	P192	2-4	R9313	P179	6-3	S07878-001	P114	2-2
P975-3	P219	3-3	R4305-J0F-E00	P192	2-4	RCS-135(8)	P42	3-3	S07878-001	P118	2-2
P975-4	P219	3-5	R4305-J0D-E00	P192	2-5	REECE10018MM	P39	4-1	S07879-001	P114	2-2
P975/F380	P219	3-3	R4305-J0E-E00	P135	1-6	REECE10019MM	P39	4-1	S07879-001	P118	2-2
P975/F381	P219	3-5	R4305-L0E-E00	P133	1-2	REECE10020MM	P39	4-1	S07880-001	P114	2-1
PE040	P218	4-5	R4305-L0E-E0A	P133	1-3	REECE10024MM	P39	4-1	S07880-001	P118	2-1
PE211	P143	3-2	R4308-J0F-E0B	P192	3-2	REECE10029MM	P39	4-1	S08302-001	P6	4-1
PE212	P143	3-2	R4508-E0D-C00	P192	3-3	REECE10030MM	P39	4-1	S08322-001	P6	4-2
PE213	P143	3-2	R4508-H0D-D00	P131	1-5	REECE10035MM	P39	4-1	S08709-001	P221	1-4
PE214	P143	3-1	R4508-H0F-D00	P131	1-5	REECE38	P28	2-1	S08711-001	P221	1-5
PE215	P143	3-1	R4508-J0D-D00	P192	4-1	REECE38-1	P28	2-2	S08713-001	P221	1-6
PE224	P142	3-3	R4508-J0E-D00	P135	1-1	RH-9820-1	P100	1-1	S08723-001	P188	4-3
PE225	P145	3-2	R4508-J0E-D00(摩吉)	P192	3-5	RH-9820-2	P100	2-1	S08724-001	P188	4-3
PE226	P129	3-4	R4508-J0F-D00	P192	4-1	RS-100	P42	3-2	S08724-001-G	P188	4-4
PE227	P129	3-4	R4508-J0E-D00	P192	4-5	RS-100(8)	P42	3-3	S08731-001	P188	4-5
PE228	P129	3-6	R4508-J0E-D0C	P192	4-5	RS-110(8)	P43	1-1	S08732-001	P188	4-5
PE238	P166	4-3	R4508-L0E-G00	P133	1-4	RS-50	P42	2-3	S09093-001	P2	3-2
PF606C32	P155	4-1	R4508-L0E-G00	P191	1-1	RS-50(6)	P42	2-4	S09094-001	P2	3-3
PF634D03	P155	4-2	R46(4)	P46	3-2	RS-50(7)	P42	3-1	S09101-001	P2	1-6
PLK1006	P109	1-1	R4608-H0D-F00	P192	3-4	RU10	P26	4-1	S09365-001	P116	1-1
R			R4608-H0F-G00	P192	3-4	RU14					



索引表 PARTS LIST

INDUSTRIAL SEWING MACHINE SPARE PARTS

索引表 PARTS LIST



INDUSTRIAL SEWING MACHINE SPARE PARTS

品号 PART NO.	页数 PAGE	行数 LINE	品号 PART NO.	页数 PAGE	行数 LINE	品号 PART NO.	页数 PAGE	行数 LINE	品号 PART NO.	页数 PAGE	行数 LINE
S15711-001	P118	4-3	S19153-001	P124	1-2	S20494-001	P124	4-5	S36546-001	P119	3-2
S15711-001	P120	4-1	S19154-001	P124	1-1	S20494-001	P124	4-6	S36548-001	P114	3-4
S15711-001	P121	4-1	S19155-001	P124	1-1	S20494-001	P125	4-1	S36548-001	P115	3-3
S15712-001	P118	5-1	S19156-001	P188	3-1	S20494-001	P216	1-3	S36548-001	P117	3-2
S15712-001	P118	5-3	S19162-001	P124	1-3	S20579-101	P2	2.4	S36548-001	P118	3-3
S15712-001	P118	5-3	S19166-001	P124	1-4	S20582-001	P2	1-3	S36548-001	P119	3-2
S15712-001	P120	5-1	S19169-001	P125	1-1	S20583-001	P2	1-4	S36560-001	P120	3-4
S15712-001	P121	5-1	S19169-001	P188	3-2	S20896-101	P2	2.5	S36662-001	P121	3-2
S15717-001	P118	4-3	S19182-001	P188	4-2	S20897-101	P2	2.6	S36664-001	P121	3-4
S15718-001	P118	5-3	S19185-001	P125	1-4	S20898-101	P2	2.7	S36666-001	P120	3-4
S15723-001	P118	4-2	S19188-001	P125	1-4	S20899-001	P2	1.5	S36666-001	P121	3-4
S15723-001	P119	4-1	S19187-001	P125	1-4	S21104-001	P125	5-4	S36666-001	P216	1-1
S15723-001	P120	4-2	S19199-001	P123	3-5	S21230-001	P5	4-6	S36666-001.D08	P216	1-1
S15723-001	P121	4-2	S19202-001	P124	3-4	S21233-001	P5	4-7	S36622-001	P190	1-3
S15724-001	P118	5-2	S19210-001	P124	3-2	S21252-001	P6	1-2	S36624-001	P6	1-6
S15724-001	P119	5-1	S19212-001	P124	3-1	S21253-001	P6	1-1	S36625-001	P6	1-7
S15724-001	P120	5-2	S19212-001	P124	3-5	S25190-001	P124	1-3	S37194-001	P37	3-3
S15724-001	P121	5-2	S19217-001	P124	3-3	S25196-001	P125	1-2	S37195-001	P37	2-1
S15735-001	P118	4-2	S19219-001	P125	3-1	S25527-001	P188	3-2	S37195-001	P37	3-3
S15735-001	P119	4-1	S19223-101	P125	3-3	S25543-001	P124	4-4	S37196-001	P37	2-1
S15735-001	P120	4-2	S19223-101	P125	3-4	S25574-001	P124	2-2	S37196-001	P37	3-3
S15735-001	P121	4-2	S19223-101	P125	3-5	S28348-001	P2	3-4	S37197-001	P37	2-1
S15736-001	P118	5-2	S19228-101	P125	3-4	S28352-001	P2	1-2	S37197-001	P37	3-3
S15736-001	P119	5-1	S19229-001	P125	3-4	S28650-201	P2	3-6	S37198-001	P37	2-1
S15736-001	P121	5-2	S19236-001	P123	2-6	S28654-001	P2	3-7	S37198-001	P37	3-3
S15747-001	P119	4-2	S19237-101	P124	2-4	S29347-001	P3	1-3	S37199-001	P37	2-1
S15747-001	P120	4-2	S19240-001	P124	2-1	S29797-201	P3	1-4	S37199-001	P37	3-3
S15747-001	P121	4-2	S19240-001	P124	2-3	S29948-001	P124	4-2	S37200-001	P37	3-3
S15748-001	P119	5-2	S19240-001	P124	2-5	S29997-001	P189	3-1	S37201-001	P37	3-3
S15748-001	P120	5-2	S19244-101	P125	2-1	S30525-001	P125	4-5	S37202-001	P37	3-3
S15748-001	P121	5-2	S19247-001	P125	2-4	S34884-000	P100	1-1	S37208-001	P37	3-3
S15753-001	P119	4-2	S19255-001	P216	1-3	S34886-001	P100	2-1	S37209-001	P37	3-3
S15753-001	P119	4-2	S19260-001	P123	4-6	S34887-001	P100	2-1	S37671-101	P5	1-1
S15753-001	P120	4-3	S19260-001	P124	4-1	S34888-101	P100	2-1	S37672-101	P5	1-3
S15753-001	P121	4-3	S19271-001	P124	4-3	S34890-001	P100	2-1	S37675-101	P5	1-2
S15754-001	P119	5-2	S19287-201	P124	4-5	S34891-101	P100	2-1	S37676-101	P5	1-4
S15754-001	P119	5-2	S19293-001	P124	4-6	S34892-001	P100	2-1	S37703-001	P37	2-2
S15754-001	P120	5-3	S19297-001	P125	4-1	S34894-001	P100	2-1	S37704-001	P37	2-2
S15754-001	P121	5-3	S19313-201	P125	4-2	S34894-004	P100	2-1	S37705-001	P37	2-2
S15759-001	P119	4-3	S19317-101	P125	4-3	S34895-001	P100	2-1	S37706-001	P37	2-2
S15760-001	P119	5-3	S19318-101	P125	4-3	S34895-001	P5	2-2	S37707-001	P37	2-2
S15763-001	P120	5-2	S19334-001	P125	4-4	S34896-001	P100	2-1	S37708-001	P37	2-2
S15765-001	P119	4-3	S19824-001	P5	2-5	S34899-001	P100	1-1	S37709-001	P37	2-2
S15765-001	P119	4-3	S20118-001	P4	4-5	S34899-001	P5	2-1	S37723-001	P4	4-3
S15765-001	P120	4-3	S20232-001	P125	1-3	S34900-001	P100	1-1	S38015-001	P190	2-3
S15765-001	P121	4-3	S20233-001	P125	1-3	S34900-001	P5	2-3	S38015001	P97	2-1
S15766-001	P119	5-3	S20234-001	P125	1-2	S34901-001	P100	1-1	S38016001	P97	2-1
S15766-001	P119	5-3	S20235-001	P125	1-2	S35029-001	P4	4-4	S38595-001	P125	3-5
S15766-001	P120	5-3	S20236-001	P125	1-2	S35092-001	P37	2-1	S38596-001	P125	3-5
S15766-001	P121	5-3	S20239-101	P125	3-3	S35092-001	P37	3-3	S38597-001	P125	2-5
S15771-001	P119	4-3	S20240-001	P125	3-3	S35093-001	P37	2-1	S40355-101	P122	3-1
S15771-001	P119	4-3	S20241-101	P125	3-2	S35093-001	P37	3-3	S40363-101	P122	3-2
S15771-001	P120	4-3	S20242-001	P125	3-2	S35436-001	P37	1-1	S40369-001	P122	2-1
S15771-001	P121	4-3	S20243-001	P125	3-2	S35436-001M	P37	1-2	S40370-001	P122	2-2
S15772-001	P119	5-3	S20244-001	P125	2-3	S35437-001	P37	1-3	S41345-001	P37	2-3
S15772-001	P119	5-3	S20245-001	P125	2-2	S35437-001M	P37	1-4	S41346-001	P37	3-1
S15772-001	P120	5-3	S20398-001	P124	5-2	S35479-001	P37	2-2	S41347-001	P37	3-2
S15772-001	P121	5-3	S20398-001	P125	5-1	S36522-001	P120	3-2	S42053-001	P37	2-2
S16248-001	P2	4-3	S20404-001	P125	5-2	S36544-001	P114	3-2	S4305-JOB-E00	P192	3-1
S16248-001.SH	P2	4-3	S20406-001	P125	5-3	S36544-001	P114	3-6	S4305-JCP-E00	P192	2-5
S18413-001	P2	4-1	S20494-001	P123	4-6	S36544-001	P116	3-4	S44132-001	P4	4-1
S175-A	P48	3-2	S20494-001	P124	4-1	S36546-001	P114	3-4	S44134-001	P4	4-2
S18426-001	P96	2-1	S20494-001	P124	4-2	S36546-001	P115	3-3	S45900-101	P3	3-6
S19145-001	P123	1-6	S20494-001	P124	4-3	S36546-001	P117	3-2	S48006-001	P4	4-6
S19146-001	P123	1-6	S20494-001	P124	4-4	S36546-001	P118	3-3	S48236-201	P96	1-1

品号 PART NO.	页数 PAGE	行数 LINE	品号 PART NO.	页数 PAGE	行数 LINE	品号 PART NO.	页数 PAGE	行数 LINE	品号 PART NO.	页数 PAGE	行数 LINE
S48238-101	P190	1-2	SA3341-001	P97	1-1	SA6431-001	P97	1-1	SS-1060210-TP	P103	2-1
S48238-101	P96	1-1	SA3341-001	P98	1-1	SA6431-001	P98	1-1	SS-1060210-TP	P104	1-1
S48239-001	P96	1-1	SA3342-001	P97	1-1	SA6448-301	P111	1-1	SS-1060210-TP	P104	2-1
S48240-001	P96	1-1	SA3342-001	P98	1-1	SA6596-001	P97	1-1	SS-1060210-TP	P105	1-1
S48246-001	P96	1-1	SA3343-001	P97	1-1	SA6596-001	P98	1-1	SS-1060210-TP	P108	1-1
S48247001	P96	1-1	SA3343-001	P98	1-1	SA6597-001	P97	1-1	SS-1060210-TP	P108	2-1
S49029-001	P213	1-2	SA3344-001	P97	1-1	SA6597-001	P98	1-1	SS-1090510-SP	P107	2-1
S49030-001	P213	1-1	SA3344-001	P98	1-1	SA6988-001	P5	1-6	SS-2090510-SP	P106	2-1
S49988-001	P4	2-3	SA3607-001	P216	3-1	SA6989-001	P5	1-5	SS-4080310-SP	P106	2-1
S49988001	P97	2-1	SA3611-001	P216	3-2	SA7065-001	P189	4-1	SS-5090320-SP	P106	2-1
S50252-001	P101	1-1	SA3645-201	P189	3-4	SA7076-001	P100	1-1	SS-6090440-SP	P106	2-1
S50253-001	P101	1-1	SA3646-201	P189	3-4	SA7106-001	P37	3-3	SS-6110430-TP	P101	2-1
S50257-001	P101	1-1	SA3652-201	P189	3-2	SA7502-001	P189	3-3	SS-6110430-TP	P102	1-1
S50258-101	P5	2-7	SA3652-201	P97	1-1	SA7575-101	P111	1-1	SS-6110430-TP	P102	2-1
S50258-201	P101	1-1	SA3652-201	P98	2-1	SA7944-001	P4	1-7	SS-6110430-TP	P103	1-1
S50259-101	P101	1-1	SA3653-201	P189	3-2	SA7944-001	P99	2-1	SS-6110430-TP	P103	2-1
S50259-101	P5	3-1	SA3653-201	P97	1-1	SA8458-001	P190	1-1	SS-6110430-TP	P104	1-1
S50260-101	P101	1-1	SA3653-201	P98	2-1	SA8458-001	P96	1-1	SS-6110430-TP	P104	2-1
S50263-001	P101	1-1	SA3654-201	P189	3-3	SA8459-001	P5	4-5	SS-6110430-TP	P105	1-1
S50265-001	P101	1-1	SA3654-201	P98	1-1	SA8459-001	P96	1-1	SS-7060310-SP	P107	2-1
S50270-000	P101	1-1	SA3654-201	P99	1-1	SA8704-101	P111	1-1	SS-7060310-SP	P105	2-1
S50303-101	P101	1-1	SA3655-001	P190	2-2	SB0998-001	P3	3-2	SS-7080310-SP	P106	1-1
S50404-101	P5	2-6	SA3655-001	P97	1-1	SB0712-001	P189	4-3	SS-7080410-SP	P101	2-1
S50404-301	P5	2-6	SA3655-001	P98	1-1	SB0713-001	P98	2-1	SS-7080410-SP	P102	1-1
S50404-401	P101	1-1	SA3655-001	P98	2-1	SB0713-001	P99	1-1	SS-7090410-SP	P102	2-1
S50404-401	P5	2-6	SA3655-001	P99	1-1	SB0715-001	P189	4-2	SS-7090410-SP	P103	1-1
S50664-001	P189	1-4	SA3656-001	P4	2-1	SB0949-001	P189	4-5	SS-7090410-SP	P103	2-1
S50664-001(1.4)	P101	1-1	SA3658-001	P4	2-2	SB0949-001	P98	2-1	SS-7090410-SP	P104	1-1
S51248-101	P189	1-3	SA4329-001	P97	1-1	SB0951-001	P189	4-4	SS-7090410-SP	P104	2-1
S51248-101(1.2)	P101	1-1	SA4329-001	P98	1-1	SB0952-001	P189	4-4	SS-7090410-SP	P105	1-



索引表

PARTS LIST

INDUSTRIAL SEWING MACHINE SPARE PARTS

品号 PART NO.	页数 PAGE	行数 LINE	品号 PART NO.	页数 PAGE	行数 LINE	品号 PART NO.	页数 PAGE	行数 LINE	品号 PART NO.	页数 PAGE	行数 LINE
TE2907	P143	5-2	UTB0115	P18	1-7						
TE2989	P142	4-3	UTB0118	P18	1-8						
TE2990	P142	6-1	UTB0207	P18	2-1						
TE2991	P142	5-3	V								
TE2992	P145	4-2	VG56311	P211	2-4						
TE2993	P145	6-2	VH50	P28	2-8						
TE2994	P145	5-2	VT04	P25	4-2						
TE3058	P129	4-4	VT05	P25	4-1						
TE3059	P129	4-4	VT05	P26	1-4						
TE3060	P129	4-6	VT206	P26	1-5						
TE318	P201	4-10	VUT109P	P178	6-3						
TE3194	P62	3-1	W								
TE424	P218	3-1	WP-0431005-SP	P107	1-1						
TE424	P218	3-2	WP-0431005-SP	P107	1-1						
TE424	P218	3-3	WP-0431005-SP	P107	1-1						
TE424	P218	3-4	WP-0450846-SP	P101	2-1						
TE424	P218	3-5	WP-0450846-SP	P102	1-1						
TE472	P207	4-2	WP-0450846-SP	P102	2-1						
TE503	P188	1-2	WP-0450846-SP	P103	1-1						
TE531	P212	1-4	WP-0450846-SP	P103	2-1						
TK17(1 C0mexity)	P46	2-3	WP-0450846-SP	P104	1-1						
TK17(2 C0mexity)	P46	2-4	WP-0450846-SP	P104	2-1						
TK18	P46	3-1	WP-0450846-SP	P105	1-1						
TP2120014	P199	1-1	WP-0451016-SP	P106	2-1						
TP603032	P199	1-5	WP-0451016-SP	P107	1-1						
TP603053A	P199	2-1	WP-08	P8	2-5						
TP604A32	P199	2-3	WP-09	P8	2-6						
TP604A33	P199	2-4	WS-027002-KN	P107	2-1						
TP604A42	P199	2-5	Z								
TP604A43	P199	3-1	ZS04	P35	3-6						
TP604A53	P199	3-1	ZS05	P35	3-5						
TP604B33	P199	3-2	钢带刀	P63	1-1						
TP604B53	P199	3-3	皮刀	P33	2-3						
TP605C.32	P155	1-1	片皮机刀	P64	1-1						
TP605C.52	P155	1-1									
TP605C53	P200	1-3									
TP605D53	P200	1-3									
TP606CA3	P200	2-3									
TP606DA3	P200	2-4									
TP624A43	P199	2-2									
TP634D.03	P155	1-2									
TP645C53	P199	4-4									
TP645D53	P200	1-4									
TP675C53	P199	4-5									
TP683022	P199	1-2									
TP6830221	P199	1-3									
TPC00561	P200	2-5									
TPC00641	P200	2-5									
TPC13584	P200	3-1									
TPC42562	P201	1-1									
TPCL11561	P201	1-2									
TPF60600	P200	4-2									
U											
UM104	P26	3-4									
UM105	P26	3-3									
UT06E	P25	3-8									
UT07	P8	2-4									
UT08	P8	2-3									
UT317	P25	3-2									
UT318	P25	3-3									
UT506	P25	3-5									
UT507	P25	3-4									
UT758	P25	3-6									
UT759	P25	3-7									
UTB0114	P18	2-2									